

BUL642D2

High Speed, High Gain Bipolar NPN Transistor with Integrated Collector-Emitter and Built-in Efficient Antisaturation Network

The BUL642D2 is a state-of-the-art High Speed High Gain Bipolar Transistor (H2BIP). Tight dynamic characteristics and lot to lot minimum spread (150 ns on storage time) make it ideally suitable for Light Ballast Application. A new development process brings avalanche energy capability, making the device extremely rugged.

Features

- Low Base Drive Requirement
- High Peak DC Current Gain (55 Typical) @ $I_C = 300 \text{ mA}/5 \text{ V}$
- Extremely Low Storage Time Min/Max Guarantees Due to the H2BIP Structure which Minimizes the Spread
- Integrated Collector-Emitter Free Wheeling Diode
- Fully Characterized Dynamic V_{CEsat}
- "Six Sigma" Process Providing Tight and Reproducible Parameter Spreads
- Avalanche Energy 20 mJ Typical Capability
- Pb-Free Package is Available*



ON Semiconductor®

<http://onsemi.com>

**3 AMPERES
825 VOLTS
75 WATTS
POWER TRANSISTOR**

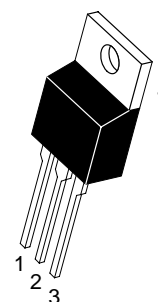
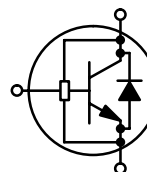

TO-220AB
CASE 221A
STYLE 1

MARKING DIAGRAM

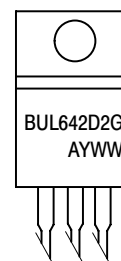

BUL642D2 = Device Code
A = Assembly Location
Y = Year
WW = Work Week
G = Pb-Free Package

ORDERING INFORMATION

Device	Package	Shipping
BUL642D2	TO-220	50 Units/Rail
BUL642D2G	TO-220 (Pb-Free)	50 Units/Rail

*For additional information on our Pb-Free strategy and soldering details, please download the ON Semiconductor Soldering and Mounting Techniques Reference Manual, SOLDERRM/D.

BUL642D2

MAXIMUM RATINGS

Rating	Symbol	Value	Unit
Collector–Emitter Sustaining Voltage	V_{CEO}	440	Vdc
Collector–Base Breakdown Voltage	V_{CES}	825	Vdc
Emitter–Base Voltage	V_{EBO}	11	Vdc
Collector Current – Continuous – Peak (Note 1)	I_C I_{CM}	3.0 8.0	Adc
Base Current – Continuous – Peak (Note 1)	I_B I_{BM}	2.0 4.0	Adc
*Total Device Dissipation @ $T_C = 25^\circ\text{C}$ *Derate above 25°C	P_D	75 0.6	W W/ $^\circ\text{C}$
Operating and Storage Temperature	T_J, T_{stg}	–65 to +150	$^\circ\text{C}$

Maximum ratings are those values beyond which device damage can occur. Maximum ratings applied to the device are individual stress limit values (not normal operating conditions) and are not valid simultaneously. If these limits are exceeded, device functional operation is not implied, damage may occur and reliability may be affected.

TYPICAL GAIN

Rating	Symbol	Value	Unit
Typical Gain @ $I_C = 1\text{ A}$, $V_{CE} = 2\text{ V}$ Typical A, $V_{CE} = 1\text{ V}$	h_{FE} h_{FE}	45 50	– –

THERMAL CHARACTERISTICS

Characteristic	Symbol	Value	Unit
Thermal Resistance, Junction–to–Case	$R_{\theta JC}$	1.6	$^\circ\text{C}/\text{W}$
Thermal Resistance, Junction–to–Ambient	$R_{\theta JA}$	62.5	$^\circ\text{C}/\text{W}$
Maximum Lead Temperature for Soldering Purposes: 1/8 in. from Case for 5 seconds	T_L	260	$^\circ\text{C}$

1. Pulse Test: Pulse Width = 5.0 ms, Duty Cycle = 10%

BUL642D2

ELECTRICAL CHARACTERISTICS ($T_C = 25^\circ\text{C}$ unless otherwise noted)

Characteristic	Symbol	Min	Typ	Max	Unit
----------------	--------	-----	-----	-----	------

OFF CHARACTERISTICS

Collector-Emitter Sustaining Voltage ($I_C = 200\text{ mA}$, $L = 25\text{ mH}$)	$V_{CEO(sus)}$	440	-	-	Vdc	
Collector-Base Breakdown Voltage ($I_{CBO} = 1\text{ mA}$)	V_{CBO}	825	-	-	Vdc	
Emitter-Base Breakdown Voltage ($I_{EBO} = 1\text{ mA}$)	V_{EBO}	11	-	-	Vdc	
Collector Cutoff Current ($V_{CE} = \text{Rated } V_{CEO}$, $I_B = 0$)	I_{CEO}	@ $T_C = 25^\circ\text{C}$	-	-	200	μAdc
		@ $T_C = 125^\circ\text{C}$	-	-	1000	
Collector Cutoff Current ($V_{CE} = \text{Rated } V_{CES}$, $V_{EB} = 0$)	I_{CES}	@ $T_C = 25^\circ\text{C}$	-	-	100	μAdc
		@ $T_C = 125^\circ\text{C}$	-	-	1000	
Emitter-Cutoff Current ($V_{EB} = 10\text{ Vdc}$, $I_C = 0$)	I_{EBO}	-	-	100	μAdc	

ON CHARACTERISTICS

Base-Emitter Saturation Voltage ($I_C = 0.5\text{ Adc}$, $I_B = 100\text{ mAdc}$ $I_C = 1\text{ Adc}$, $I_B = 0.2\text{ Adc}$)	$V_{BE(sat)}$	-	-	1.1 1.5	Vdc
Collector-Emitter Saturation Voltage ($I_C = 0.5\text{ Adc}$, $I_B = 50\text{ mAdc}$ $I_C = 2\text{ Adc}$, $I_B = 0.2\text{ Adc}$)	$V_{CE(sat)}$	-	-	0.5 1.5	Vdc
DC Current Gain ($I_C = 0.5\text{ Adc}$, $V_{CE} = 1\text{ Vdc}$ $I_C = 0.5\text{ Adc}$, $V_{CE} = 3\text{ Vdc}$)	h_{FE}	16 18	-	-	-

DYNAMIC SATURATION VOLTAGE

Dynamic Saturation Voltage:	$I_C = 0.5\text{ Adc}$ $I_{B1} = 50\text{ mAdc}$ $V_{CC} = 125\text{ Vdc}$	@ $1\ \mu\text{s}$	@ $T_C = 25^\circ\text{C}$ @ $T_C = 125^\circ\text{C}$	$V_{CE(dsat)}$	-	2.0	-	V
		@ $3\ \mu\text{s}$	@ $T_C = 25^\circ\text{C}$		-	5.0	-	
	$I_C = 1\text{ Adc}$ $I_{B1} = 100\text{ mAdc}$ $V_{CC} = 300\text{ Vdc}$	@ $1\ \mu\text{s}$	@ $T_C = 25^\circ\text{C}$ @ $T_C = 125^\circ\text{C}$		-	0.2	-	
		@ $3\ \mu\text{s}$	@ $T_C = 25^\circ\text{C}$		-	1.3	-	
		@ $1\ \mu\text{s}$	@ $T_C = 25^\circ\text{C}$ @ $T_C = 125^\circ\text{C}$		-	4.5	-	
		@ $3\ \mu\text{s}$	@ $T_C = 25^\circ\text{C}$		-	10	-	
					-	1.0	-	
					-	3.0	-	

DYNAMIC CHARACTERISTICS

Current Gain Bandwidth $I_C = 0.5\text{ Adc}$, $V_{CE} = 10\text{ Vdc}$, $f = 1\text{ MHz}$	f_T	-	13	-	MHz
Output Capacitance @ $V_{cb} = 10\text{ V}$, $I_E = 0$, $f = 1\text{ MHz}$	C_{ob}	-	70	150	pF
Input Capacitance @ $V_{EB} = 8\text{ V}$, $f = 1\text{ MHz}$	C_{ib}	-	500	1000	pF

DIODE CHARACTERISTICS

Forward Diode Voltage ($I_{EC} = 0.5\text{ Adc}$) ($I_{EC} = 1.0\text{ Adc}$)	V_{EC}	-	0.8 1.0	1.5 2.0	V
---	----------	---	------------	------------	---

SWITCHING CHARACTERISTICS: Resistive Load (D.C. $\leq 10\%$, Pulse Width = $70\ \mu\text{s}$)

Delay Time	$I_C = 0.5\text{ Adc}$	t_d	-	60	400	ns
Rise Time	$I_{B1} = 45\text{ mA}$	t_r	-	160	1100	ns
Storage Time	$I_{B2} = 500\text{ mA}$	t_s	-	0.5	1400	μs
Fall Time	$V_{CC} = 125\text{ V}$	t_f	-	0.4	600	ns

BUL642D2

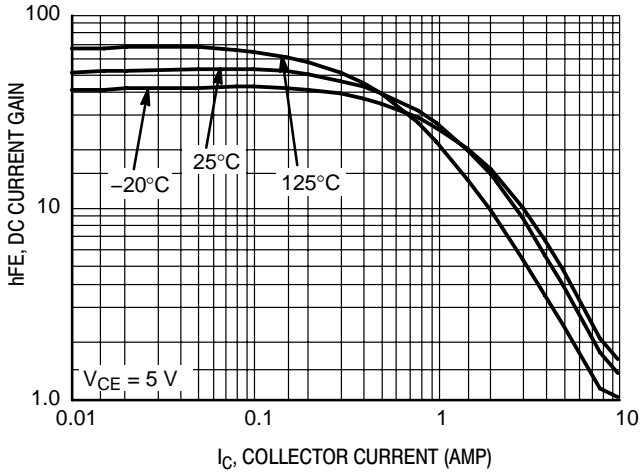

Figure 1. DC Current Gain

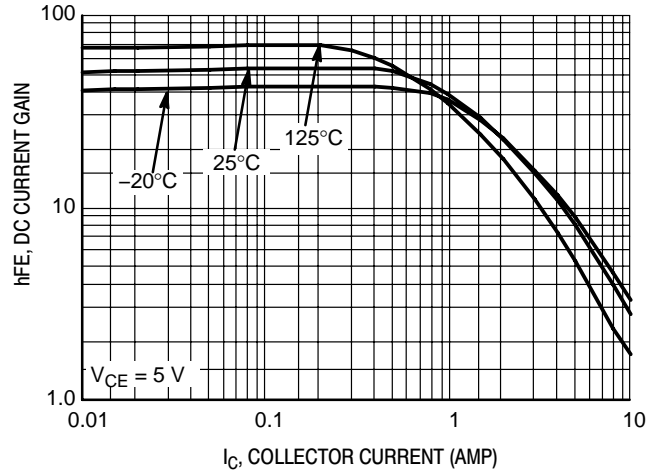

Figure 2. DC Current Gain

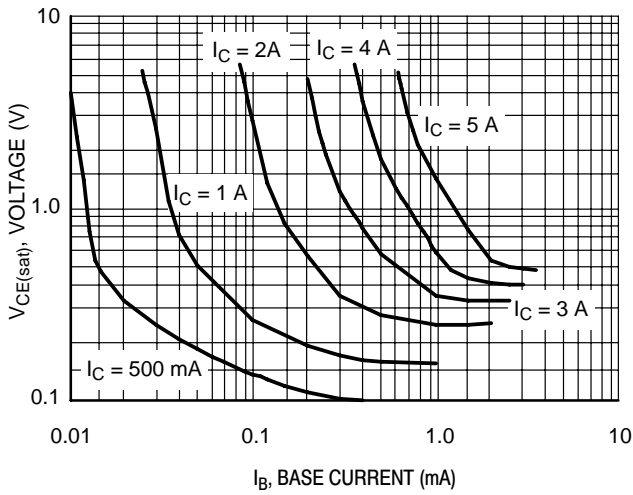

Figure 3. Collector Saturation Region

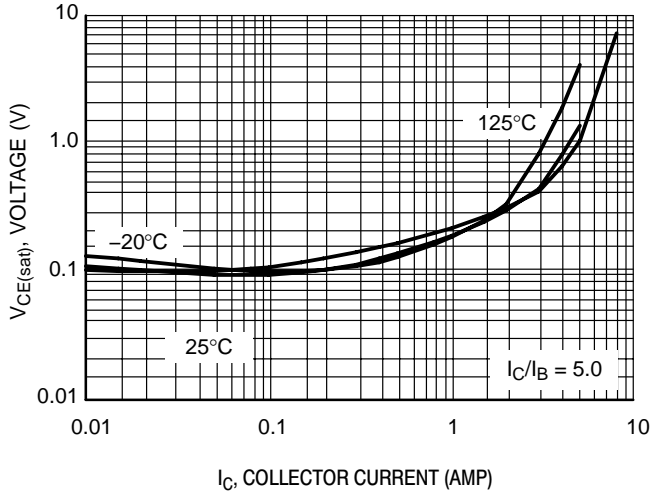

Figure 4. Collector-Emitter Saturation Voltage

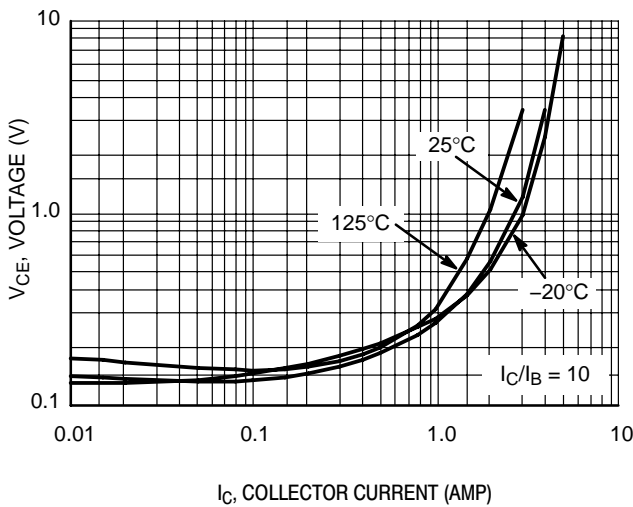

Figure 5. Collector-Emitter Saturation Voltage

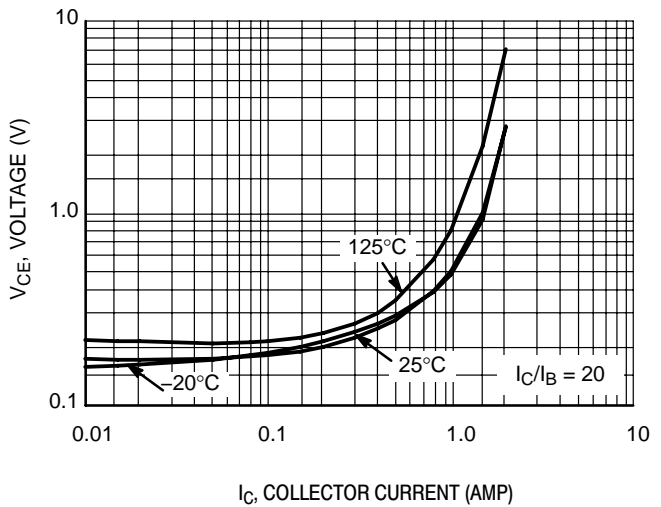

Figure 6. Collector-Emitter Saturation Voltage

BUL642D2

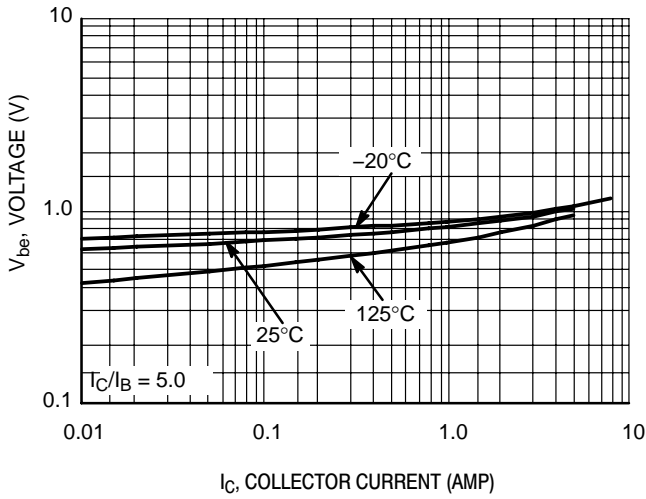

Figure 7. Base-Emitter Saturation Voltage

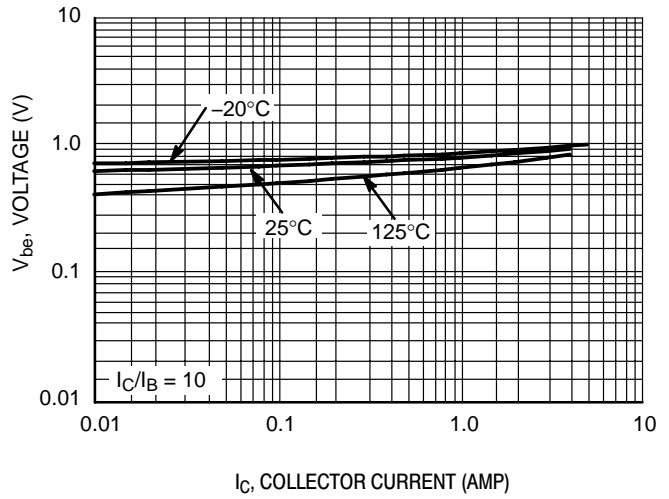

Figure 8. Base-Emitter Saturation Voltage

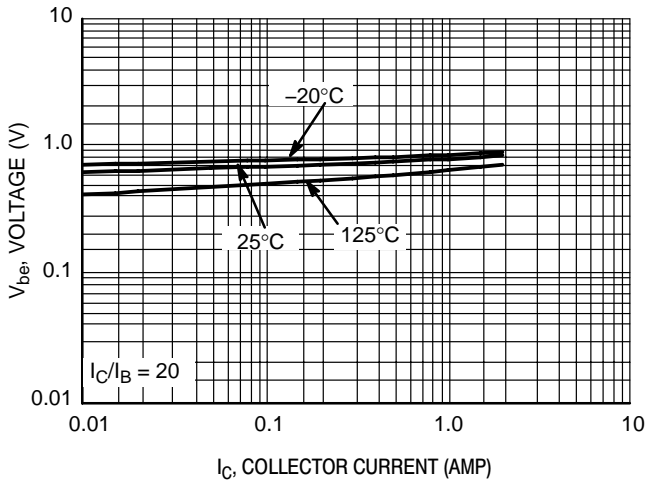

Figure 9. Base-Emitter Saturation Voltage

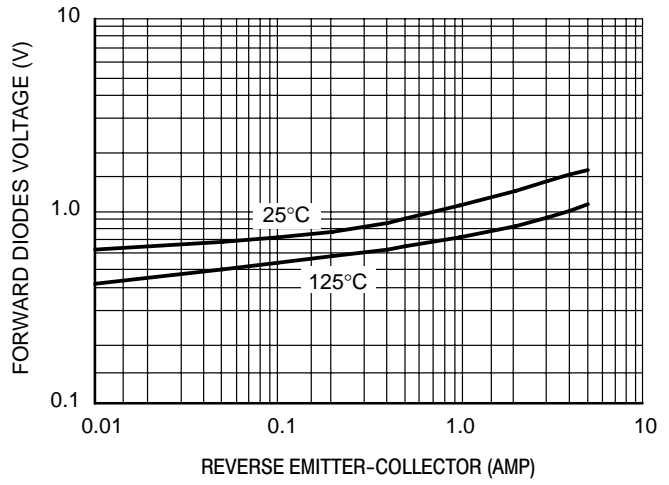

Figure 10. Forward Diode Voltage

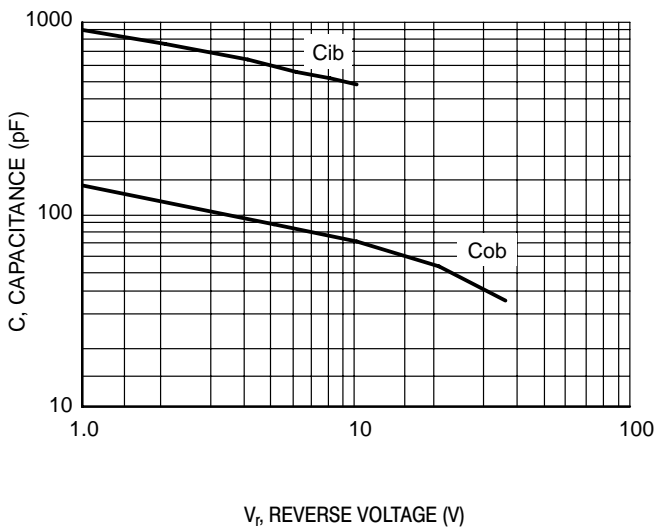

Figure 11. Capacitance

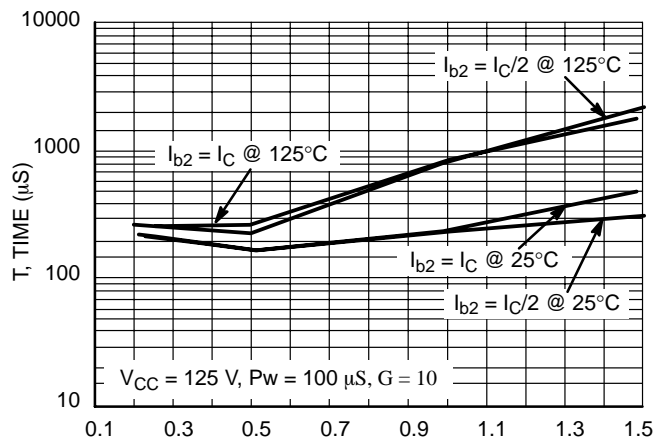

Figure 12. Resistive Switch Time, Storage Time T_{ON}

BUL642D2

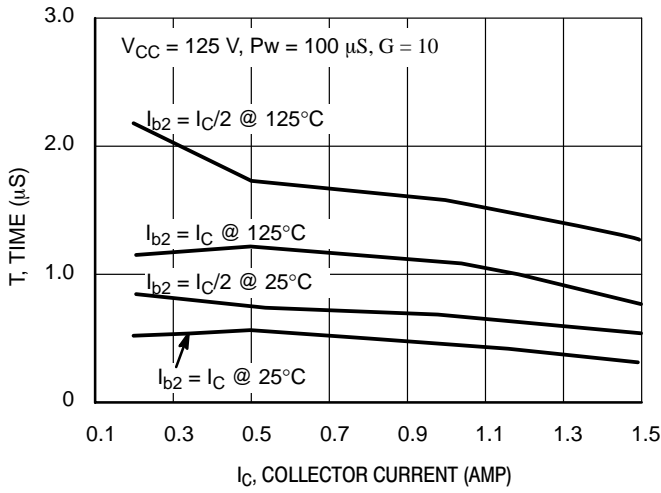

Figure 13. Resistive Switch Time, Storage Time

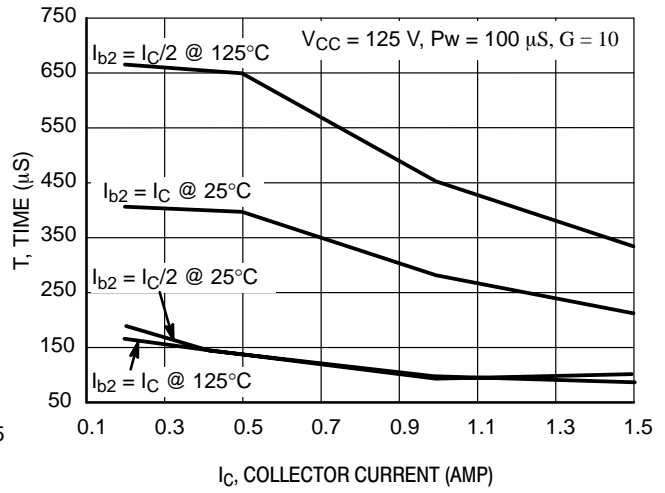

Figure 14. Resistive Switch Time, Fall Time

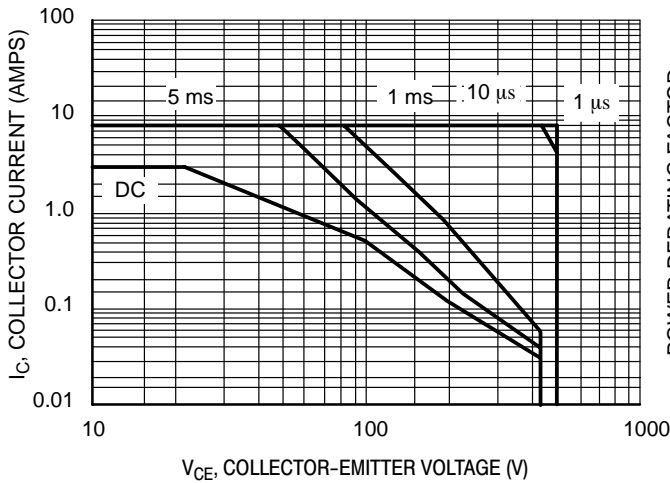

Figure 15.

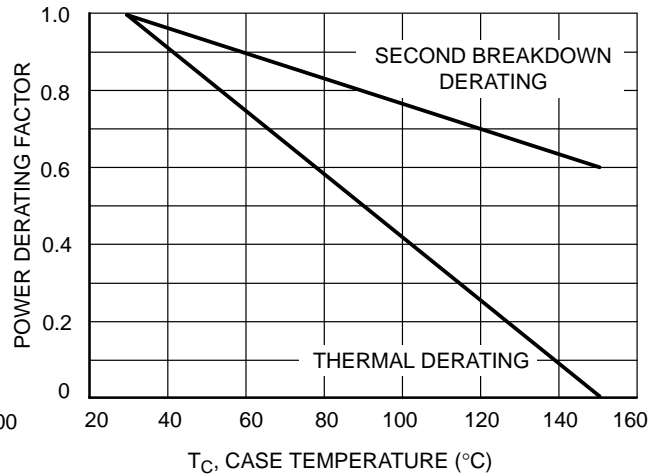

Figure 16. Power Derating

There are two limitations on the power handling ability of a transistor: average junction temperature and second breakdown. Safe operating area curves indicate I_C - V_{CE} limits of the transistor that must be observed for reliable operation; i.e., the transistor must not be subjected to greater dissipation than the curves indicate. The data of Figure 15 is based on $T_C = 25^\circ\text{C}$; $T_{j(pk)}$ is variable depending on power level. Second breakdown pulse limits do not derate like

thermal limitations. Allowable current at the voltages shown on Figure 10 may be found at any case temperature by using the appropriate curve on Figure 16.

$T_{j(pk)}$ may be calculated from the data in Figure 18. At any case temperatures, thermal limitations will reduce the power that can be handled to values less than the limitations imposed by second breakdown.

BUL642D2

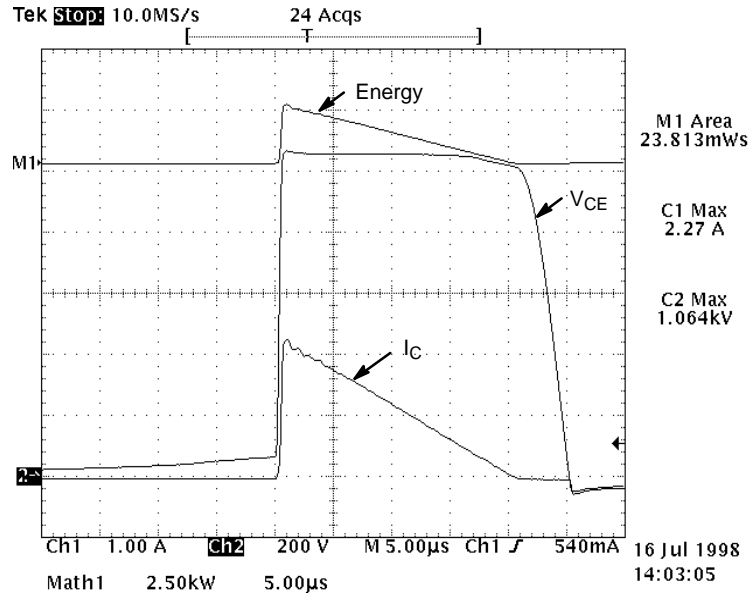

NPD CHARACTERIZATION LAB

Figure 17. Typical Avalanche Energy Test/Waveforms

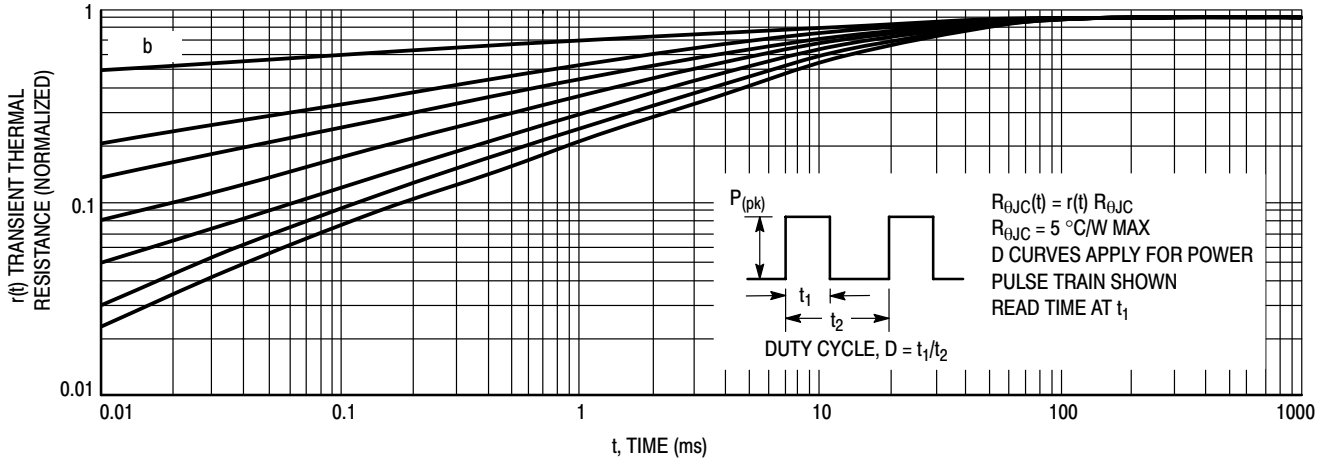
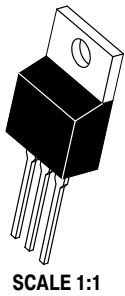

Figure 18. Thermal Response

MECHANICAL CASE OUTLINE PACKAGE DIMENSIONS



TO-220 CASE 221A ISSUE AK

DATE 13 JAN 2022

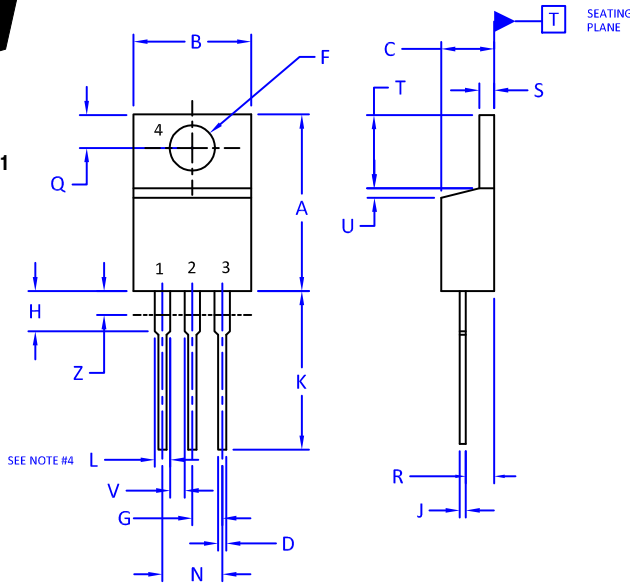

NOTES:

1. DIMENSIONING AND TOLERANCING PER ANSI Y14.5M, 2009.
2. CONTROLLING DIMENSION: INCHES
3. DIMENSION Z DEFINES A ZONE WHERE ALL BODY AND LEAD IRREGULARITIES ARE ALLOWED.
4. MAX WIDTH FOR F102 DEVICE = 1.35MM

DIM	INCHES		MILLIMETERS	
	MIN.	MAX.	MIN.	MAX.
A	0.570	0.620	14.48	15.75
B	0.380	0.415	9.66	10.53
C	0.160	0.190	4.07	4.83
D	0.025	0.038	0.64	0.96
F	0.142	0.161	3.60	4.09
G	0.095	0.105	2.42	2.66
H	0.110	0.161	2.80	4.10
J	0.014	0.024	0.36	0.61
K	0.500	0.562	12.70	14.27
L	0.045	0.060	1.15	1.52
N	0.190	0.210	4.83	5.33
Q	0.100	0.120	2.54	3.04
R	0.080	0.110	2.04	2.79
S	0.045	0.055	1.15	1.41
T	0.235	0.255	5.97	6.47
U	0.000	0.050	0.00	1.27
V	0.045	---	1.15	---
Z	---	0.080	---	2.04

STYLE 1:

- PIN 1. BASE
- 2. COLLECTOR
- 3. EMITTER
- 4. COLLECTOR

STYLE 2:

- PIN 1. BASE
- 2. EMITTER
- 3. COLLECTOR
- 4. EMITTER

STYLE 3:

- PIN 1. CATHODE
- 2. ANODE
- 3. GATE
- 4. ANODE

STYLE 4:

- PIN 1. MAIN TERMINAL 1
- 2. MAIN TERMINAL 2
- 3. GATE
- 4. MAIN TERMINAL 2

STYLE 5:

- PIN 1. GATE
- 2. DRAIN
- 3. SOURCE
- 4. DRAIN

STYLE 6:

- PIN 1. ANODE
- 2. CATHODE
- 3. ANODE
- 4. CATHODE

STYLE 7:

- PIN 1. CATHODE
- 2. ANODE
- 3. CATHODE
- 4. ANODE

STYLE 8:

- PIN 1. CATHODE
- 2. ANODE
- 3. EXTERNAL TRIP/DELAY
- 4. ANODE

STYLE 9:

- PIN 1. GATE
- 2. COLLECTOR
- 3. EMITTER
- 4. COLLECTOR

STYLE 10:

- PIN 1. GATE
- 2. SOURCE
- 3. DRAIN
- 4. SOURCE

STYLE 11:

- PIN 1. DRAIN
- 2. SOURCE
- 3. GATE
- 4. SOURCE

STYLE 12:

- PIN 1. MAIN TERMINAL 1
- 2. MAIN TERMINAL 2
- 3. GATE
- 4. NOT CONNECTED

DOCUMENT NUMBER:	98ASB42148B	Electronic versions are uncontrolled except when accessed directly from the Document Repository. Printed versions are uncontrolled except when stamped "CONTROLLED COPY" in red.
DESCRIPTION:	TO-220	PAGE 1 OF 1

onsemi and ONSEMI are trademarks of Semiconductor Components Industries, LLC dba onsemi or its subsidiaries in the United States and/or other countries. onsemi reserves the right to make changes without further notice to any products herein. onsemi makes no warranty, representation or guarantee regarding the suitability of its products for any particular purpose, nor does onsemi assume any liability arising out of the application or use of any product or circuit, and specifically disclaims any and all liability, including without limitation special, consequential or incidental damages. onsemi does not convey any license under its patent rights nor the rights of others.

onsemi, **Onsemi**, and other names, marks, and brands are registered and/or common law trademarks of Semiconductor Components Industries, LLC dba "**onsemi**" or its affiliates and/or subsidiaries in the United States and/or other countries. **onsemi** owns the rights to a number of patents, trademarks, copyrights, trade secrets, and other intellectual property. A listing of **onsemi**'s product/patent coverage may be accessed at www.onsemi.com/site/pdf/Patent-Marking.pdf. **onsemi** reserves the right to make changes at any time to any products or information herein, without notice. The information herein is provided "as-is" and **onsemi** makes no warranty, representation or guarantee regarding the accuracy of the information, product features, availability, functionality, or suitability of its products for any particular purpose, nor does **onsemi** assume any liability arising out of the application or use of any product or circuit, and specifically disclaims any and all liability, including without limitation special, consequential or incidental damages. Buyer is responsible for its products and applications using **onsemi** products, including compliance with all laws, regulations and safety requirements or standards, regardless of any support or applications information provided by **onsemi**. "Typical" parameters which may be provided in **onsemi** data sheets and/or specifications can and do vary in different applications and actual performance may vary over time. All operating parameters, including "Typicals" must be validated for each customer application by customer's technical experts. **onsemi** does not convey any license under any of its intellectual property rights nor the rights of others. **onsemi** products are not designed, intended, or authorized for use as a critical component in life support systems or any FDA Class 3 medical devices or medical devices with a same or similar classification in a foreign jurisdiction or any devices intended for implantation in the human body. Should Buyer purchase or use **onsemi** products for any such unintended or unauthorized application, Buyer shall indemnify and hold **onsemi** and its officers, employees, subsidiaries, affiliates, and distributors harmless against all claims, costs, damages, and expenses, and reasonable attorney fees arising out of, directly or indirectly, any claim of personal injury or death associated with such unintended or unauthorized use, even if such claim alleges that **onsemi** was negligent regarding the design or manufacture of the part. **onsemi** is an Equal Opportunity/Affirmative Action Employer. This literature is subject to all applicable copyright laws and is not for resale in any manner.

PUBLICATION ORDERING INFORMATION

LITERATURE FULFILLMENT:

Email Requests to: orderlit@onsemi.com

onsemi Website: www.onsemi.com

TECHNICAL SUPPORT

North American Technical Support:

Voice Mail: 1 800-282-9855 Toll Free USA/Canada

Phone: 011 421 33 790 2910

Europe, Middle East and Africa Technical Support:

Phone: 00421 33 790 2910

For additional information, please contact your local Sales Representative