

# NTJD4152P, NVJD4152P

## MOSFET – Dual, P-Channel, Trench Small Signal, ESD Protected, SC-88

### 20 V, 0.88 A



ON Semiconductor®

[www.onsemi.com](http://www.onsemi.com)

#### Features

- Leading Trench Technology for Low  $R_{DS(on)}$  Performance
- Small Footprint Package (SC70–6 Equivalent)
- ESD Protected Gate
- NV Prefix for Automotive and Other Applications Requiring Unique Site and Control Change Requirements; AEC–Q101 Qualified and PPAP Capable
- These are Pb–Free Devices

#### Applications

- Load/Power Management
- Charging Circuits
- Load Switching
- Cell Phones, Computing, Digital Cameras, MP3s and PDAs

#### MAXIMUM RATINGS ( $T_J = 25^\circ\text{C}$ unless otherwise stated)

| Parameter   |              | Symbol         | Value                    | Unit             |   |
|---|--------------|----------------|--------------------------|------------------|---|
| Drain–to–Source Voltage   |              | $V_{DSS}$      | –20                      | V                |   |
| Gate–to–Source Voltage  |              | $V_{GS}$       | $\pm 12$                 | V                |   |
| Continuous Drain Current (Note 1)                                 | Steady State | $I_D$          | $T_A = 25^\circ\text{C}$ | –0.88            | A |
|   |              |                | $T_A = 85^\circ\text{C}$ | –0.63            |   |
| Power Dissipation (Note 1)  | Steady State | $P_D$          | $T_A = 25^\circ\text{C}$ | 0.272            | W |
|   |              |                | $T_A = 85^\circ\text{C}$ | 0.141            |   |
| Continuous Drain Current (Note 2)                                 | $t \leq 5$ s | $I_D$          | $T_A = 25^\circ\text{C}$ | –1.0             | A |
|   |              |                | $T_A = 85^\circ\text{C}$ | –0.72            |   |
| Power Dissipation (Note 2)  | $t \leq 5$ s | $P_D$          | $T_A = 25^\circ\text{C}$ | 0.35             | W |
|   |              |                | $T_A = 85^\circ\text{C}$ | 0.181            |   |
| Pulsed Drain Current  |              | $I_{DM}$       | $\pm 3.0$                | A                |   |
| Operating Junction and Storage Temperature                        |              | $T_J, T_{STG}$ | –55 to 150               | $^\circ\text{C}$ |   |
| Continuous Source Current (Body Diode)                            |              | $I_S$          | –0.48                    | A                |   |
| Lead Temperature for Soldering Purposes (1/8" from case for 10 s) |              | $T_L$          | 260                      | $^\circ\text{C}$ |   |

#### THERMAL RESISTANCE RATINGS (Note 1)

| Parameter                          | Symbol          | Max | Unit                      |
|------------------------------------|-----------------|-----|---------------------------|
| Junction–to–Ambient – Steady State | $R_{\theta JA}$ | 460 | $^\circ\text{C}/\text{W}$ |
| Junction–to–Ambient – $t \leq 5$ s | $R_{\theta JA}$ | 357 |                           |
| Junction–to–Lead – Steady State    | $R_{\theta JL}$ | 226 |                           |

Stresses exceeding those listed in the Maximum Ratings table may damage the device. If any of these limits are exceeded, device functionality should not be assumed, damage may occur and reliability may be affected.

1. Surface mounted on FR4 board using 1 in sq pad size (Cu area = 1.127 in sq [1 oz] including traces), steady state.

| $V_{(BR)DSS}$ | $R_{DS(on)}$ Typ        | $I_D$ Max |
|---------------|-------------------------|-----------|
| –20 V         | 215 m $\Omega$ @ –4.5 V | –0.88 A   |
|               | 345 m $\Omega$ @ –2.5 V |           |
|               | 600 m $\Omega$ @ –1.8 V |           |

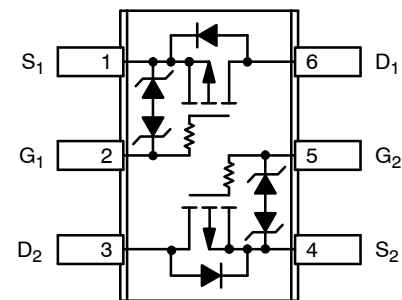

Top View

#### MARKING DIAGRAM & PIN ASSIGNMENT

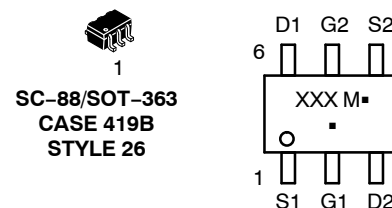

XXX = Device Code  
M = Date Code  
▪ = Pb–Free Package

(Note: Microdot may be in either location)

#### ORDERING INFORMATION

See detailed ordering and shipping information in the package dimensions section on page 5 of this data sheet.

## NTJD4152P, NVJD4152P

2. Surface mounted on FR4 board using 1 in sq pad size  
(Cu area = 1.127 in sq [1 oz] including traces),  $t \leq 5$  s.

# NTJD4152P, NVJD4152P

## ELECTRICAL CHARACTERISTICS ( $T_J=25^\circ\text{C}$ unless otherwise stated)

| Parameter | Symbol | Test Condition | Min | Typ | Max | Unit |
|-----------|--------|----------------|-----|-----|-----|------|
|-----------|--------|----------------|-----|-----|-----|------|

### OFF CHARACTERISTICS

|                                   |               |  |                           |      |      |               |
|-----------------------------------|---------------|--|---------------------------|------|------|---------------|
| Drain-to-Source Breakdown Voltage | $V_{(BR)DSS}$ | $V_{GS} = 0\text{ V}, I_D = -250\ \mu\text{A}$   | -20                       |      |      | V             |
| Zero Gate Voltage Drain Current   | $I_{DSS}$     | $V_{GS} = 0\text{ V}, V_{DS} = -16\text{ V}$     | $T_J = 25^\circ\text{C}$  |      | -1.0 | $\mu\text{A}$ |
|                                   |               |  | $T_J = 125^\circ\text{C}$ |      | -1.0 |               |
| Gate-to-Source Leakage Current    | $I_{GSS}$     | $V_{DS} = 0\text{ V}, V_{GS} = \pm 4.5\text{ V}$ |                           | 0.03 | 1.0  | $\mu\text{A}$ |
|                                   |               | $V_{DS} = 0\text{ V}, V_{GS} = \pm 12\text{ V}$  |                           | 6.0  |      |               |

### ON CHARACTERISTICS (Note 3)

|                               |              |  |       |     |      |                  |
|-------------------------------|--------------|--|-------|-----|------|------------------|
| Gate Threshold Voltage        | $V_{GS(TH)}$ | $V_{GS} = V_{DS}, I_D = -250\ \mu\text{A}$     | -0.45 |     | -1.2 | V                |
| Drain-to-Source On Resistance | $R_{DS(on)}$ | $V_{GS} = -4.5\text{ V}, I_D = -0.88\text{ A}$ |       | 215 | 260  | $\text{m}\Omega$ |
|                               |              | $V_{GS} = -2.5\text{ V}, I_D = -0.71\text{ A}$ |       | 345 | 500  |                  |
|                               |              | $V_{GS} = -1.8\text{ V}, I_D = -0.20\text{ A}$ |       | 600 | 1000 |                  |
| Forward Transconductance      | $g_{FS}$     | $V_{DS} = -10\text{ V}, I_D = -0.88\text{ A}$  |       | 3.0 |      | S                |

### CHARGES AND CAPACITANCES

|                              |              |   |  |      |  |             |
|------------------------------|--------------|---|--|------|--|-------------|
| Input Capacitance            | $C_{ISS}$    | $V_{GS} = 0\text{ V}, f = 1.0\text{ MHz}, V_{DS} = -20\text{ V}$      |  | 155  |  | $\text{pF}$ |
| Output Capacitance           | $C_{OSS}$    |   |  | 25   |  |             |
| Reverse Transfer Capacitance | $C_{RSS}$    |   |  | 18   |  |             |
| Total Gate Charge            | $Q_{G(TOT)}$ | $V_{GS} = -4.5\text{ V}, V_{DS} = -10\text{ V}, I_D = -0.88\text{ A}$ |  | 2.2  |  | $\text{nC}$ |
| Gate-to-Source Charge        | $Q_{GS}$     |   |  | 0.5  |  |             |
| Gate-to-Drain Charge         | $Q_{GD}$     |   |  | 0.65 |  |             |

### SWITCHING CHARACTERISTICS (Note 4)

|                     |              |  |  |      |  |    |
|---------------------|--------------|--|--|------|--|----|
| Turn-On Delay Time  | $t_{d(ON)}$  | $V_{GS} = -4.5\text{ V}, V_{DD} = -10\text{ V}, I_D = -0.5\text{ A}, R_G = 20\ \Omega$ |  | 5.8  |  | ns |
| Rise Time           | $t_r$        |  |  | 6.5  |  |    |
| Turn-Off Delay Time | $t_{d(OFF)}$ |  |  | 13.5 |  |    |
| Fall Time           | $t_f$        |  |  | 3.5  |  |    |

### DRAIN-SOURCE DIODE CHARACTERISTICS

|                       |          |   |                           |  |       |      |   |
|-----------------------|----------|---|---------------------------|--|-------|------|---|
| Forward Diode Voltage | $V_{SD}$ | $V_{GS} = 0\text{ V}, I_S = -0.48\text{ A}$ | $T_J = 25^\circ\text{C}$  |  | -0.8  | -1.2 | V |
|                       |          |   | $T_J = 125^\circ\text{C}$ |  | -0.66 |      |   |

Product parametric performance is indicated in the Electrical Characteristics for the listed test conditions, unless otherwise noted. Product performance may not be indicated by the Electrical Characteristics if operated under different conditions.

3. Pulse Test: pulse width  $\leq 300\ \mu\text{s}$ , duty cycle  $\leq 2\%$ .

4. Switching characteristics are independent of operating junction temperatures.

# NTJD4152P, NVJD4152P

## TYPICAL PERFORMANCE CURVES ( $T_J = 25^\circ\text{C}$ unless otherwise noted)

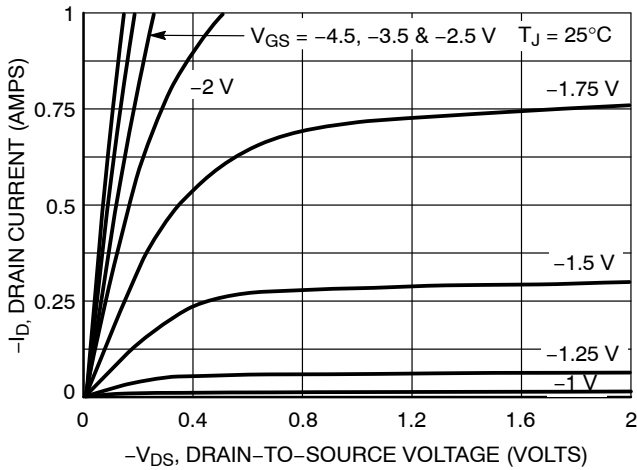

**Figure 1. On-Region Characteristics**

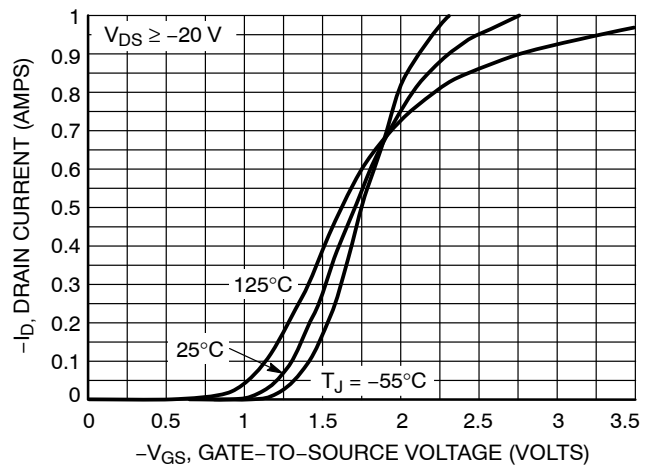

**Figure 2. Transfer Characteristics**

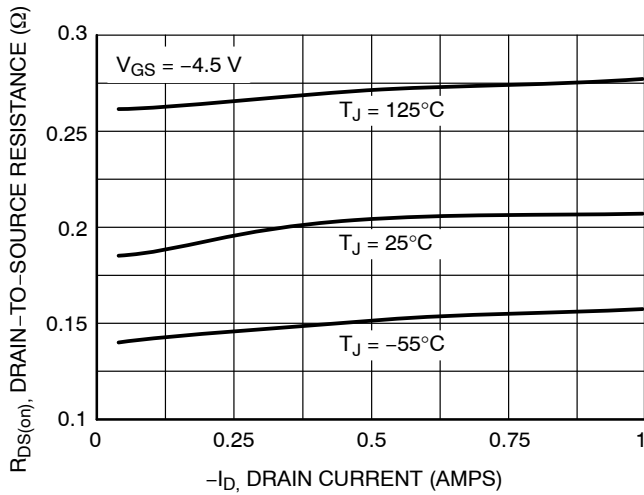

**Figure 3. On-Resistance vs. Drain Current and Temperature**

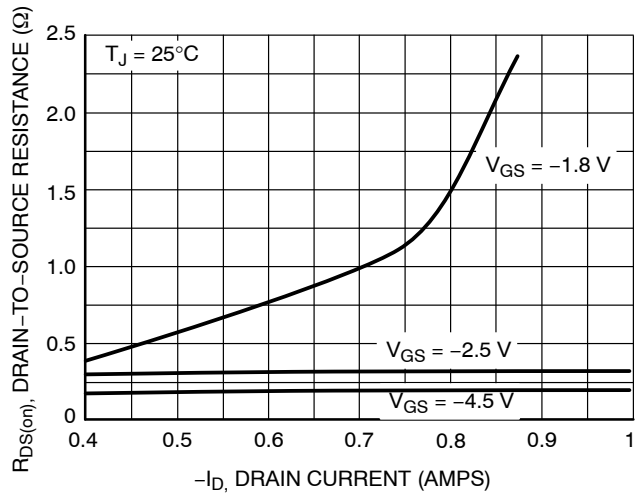

**Figure 4. On-Resistance vs. Drain Current and Gate Voltage**

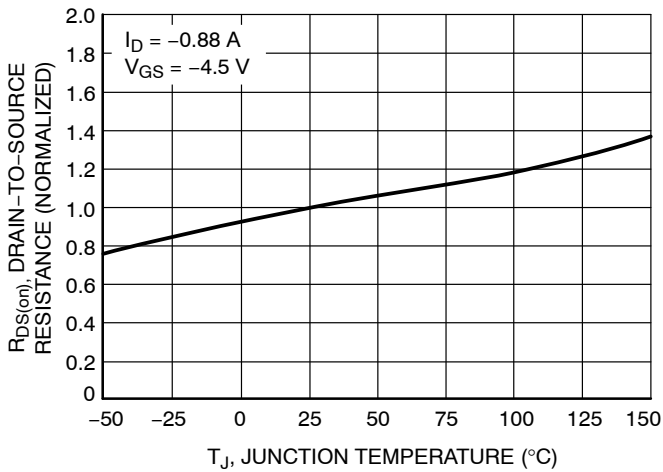

**Figure 5. On-Resistance Variation with Temperature**

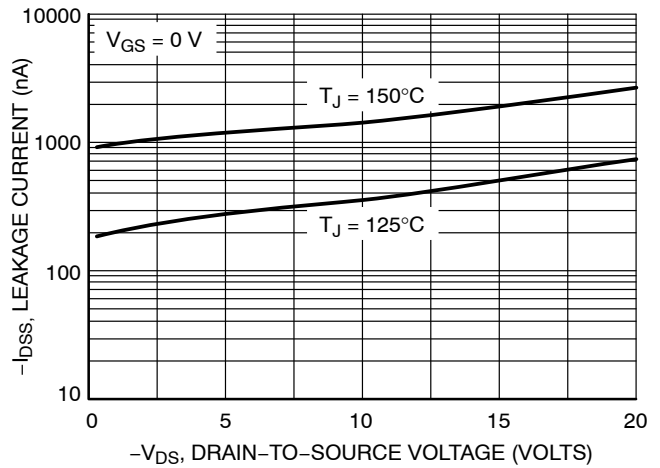

**Figure 6. Drain-to-Source Leakage Current vs. Voltage**

# NTJD4152P, NVJD4152P

## TYPICAL PERFORMANCE CURVES ( $T_J = 25^\circ\text{C}$ unless otherwise noted)

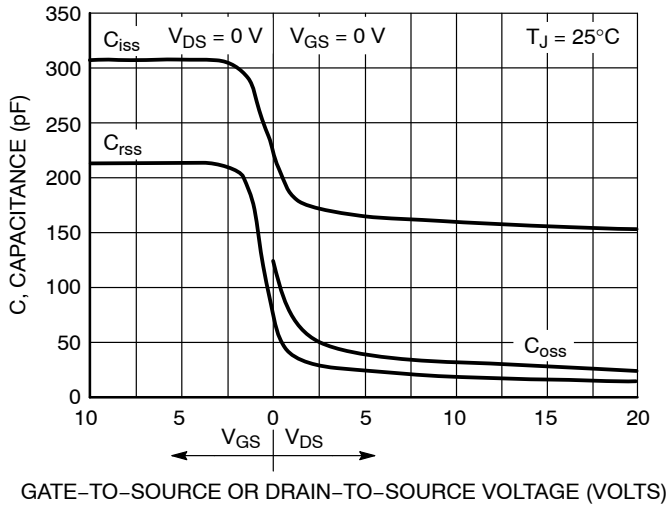

**Figure 7. Capacitance Variation**

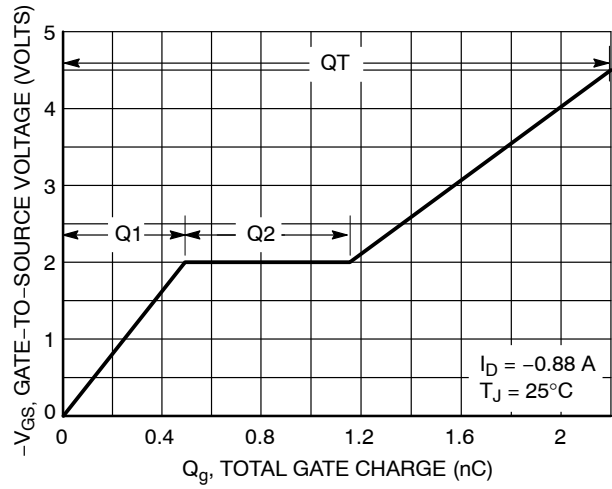

**Figure 8. Gate-to-Source Voltage vs. Total Gate Charge**

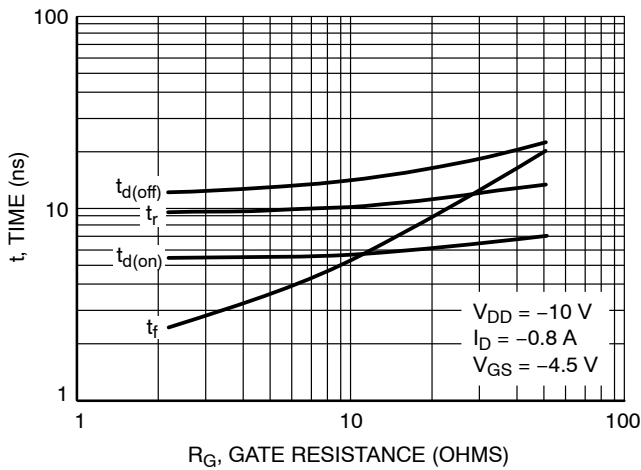

**Figure 9. Resistive Switching Time Variation vs. Gate Resistance**

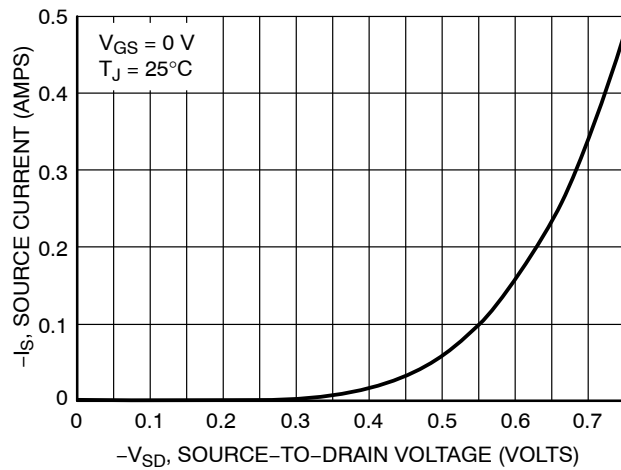

**Figure 10. Diode Forward Voltage vs. Current**

### ORDERING INFORMATION

| Device        | Marking | Package            | Shipping <sup>†</sup> |
|---------------|---------|--------------------|-----------------------|
| NTJD4152PT1G  | TK      | SC-88<br>(Pb-Free) | 3000 / Tape & Reel    |
| NTJD4152PT2G  | TK      |                    |                       |
| NVJD4152PT1G* | VTK     |                    |                       |

<sup>†</sup>For information on tape and reel specifications, including part orientation and tape sizes, please refer to our Tape and Reel Packaging Specifications Brochure, BRD8011/D.

\*NV Prefix for Automotive and Other Applications Requiring Unique Site and Control Change Requirements; AEC-Q101 Qualified and PPAP Capable.



1  
SCALE 2:1

SC-88/SC70-6/SOT-363  
CASE 419B-02  
ISSUE Y

DATE 11 DEC 2012

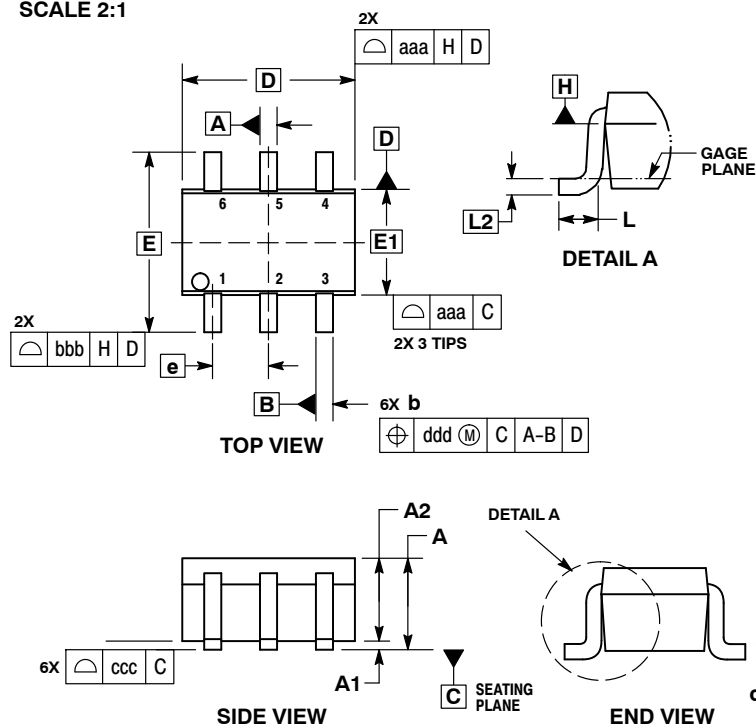

- NOTES:
1. DIMENSIONING AND TOLERANCING PER ASME Y14.5M, 1994.
  2. CONTROLLING DIMENSION: MILLIMETERS.
  3. DIMENSIONS D AND E1 DO NOT INCLUDE MOLD FLASH, PROTRUSIONS, OR GATE BURRS. MOLD FLASH, PROTRUSIONS, OR GATE BURRS SHALL NOT EXCEED 0.20 PER END.
  4. DIMENSIONS D AND E1 AT THE OUTERMOST EXTREMES OF THE PLASTIC BODY AND DATUM H.
  5. DATUMS A AND B ARE DETERMINED AT DATUM H.
  6. DIMENSIONS b AND c APPLY TO THE FLAT SECTION OF THE LEAD BETWEEN 0.08 AND 0.15 FROM THE TIP.
  7. DIMENSION b DOES NOT INCLUDE DAMBAR PROTRUSION. ALLOWABLE DAMBAR PROTRUSION SHALL BE 0.08 TOTAL IN EXCESS OF DIMENSION b AT MAXIMUM MATERIAL CONDITION. THE DAMBAR CANNOT BE LOCATED ON THE LOWER RADIUS OF THE FOOT.

| DIM | MILLIMETERS |      |      | INCHES    |       |       |
|-----|-------------|------|------|-----------|-------|-------|
|     | MIN         | NOM  | MAX  | MIN       | NOM   | MAX   |
| A   | ---         | ---  | 1.10 | ---       | ---   | 0.043 |
| A1  | 0.00        | ---  | 0.10 | 0.000     | ---   | 0.004 |
| A2  | 0.70        | 0.90 | 1.00 | 0.027     | 0.035 | 0.039 |
| b   | 0.15        | 0.20 | 0.25 | 0.006     | 0.008 | 0.010 |
| C   | 0.08        | 0.15 | 0.22 | 0.003     | 0.006 | 0.009 |
| D   | 1.80        | 2.00 | 2.20 | 0.070     | 0.078 | 0.086 |
| E   | 2.00        | 2.10 | 2.20 | 0.078     | 0.082 | 0.086 |
| E1  | 1.15        | 1.25 | 1.35 | 0.045     | 0.049 | 0.053 |
| e   | 0.65 BSC    |      |      | 0.026 BSC |       |       |
| L   | 0.26        | 0.36 | 0.46 | 0.010     | 0.014 | 0.018 |
| L2  | 0.15 BSC    |      |      | 0.006 BSC |       |       |
| aaa | 0.15        |      |      | 0.006     |       |       |
| bbb | 0.30        |      |      | 0.012     |       |       |
| ccc | 0.10        |      |      | 0.004     |       |       |
| ddd | 0.10        |      |      | 0.004     |       |       |

### GENERIC MARKING DIAGRAM\*

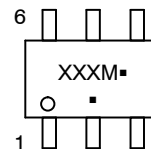

- XXX = Specific Device Code
- M = Date Code\*
- = Pb-Free Package

(Note: Microdot may be in either location)

\*Date Code orientation and/or position may vary depending upon manufacturing location.

\*This information is generic. Please refer to device data sheet for actual part marking. Pb-Free indicator, "G" or microdot "▪", may or may not be present. Some products may not follow the Generic Marking.

### RECOMMENDED SOLDERING FOOTPRINT\*

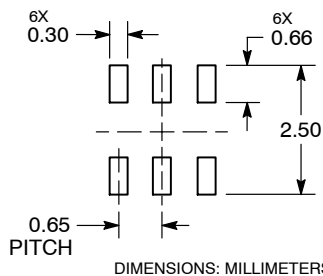

\*For additional information on our Pb-Free strategy and soldering details, please download the ON Semiconductor Soldering and Mounting Techniques Reference Manual, SOLDERRM/D.

### STYLES ON PAGE 2

|                  |                      |  |
|------------------|----------------------|--|
| DOCUMENT NUMBER: | 98ASB42985B          | Electronic versions are uncontrolled except when accessed directly from the Document Repository. Printed versions are uncontrolled except when stamped "CONTROLLED COPY" in red. |
| DESCRIPTION:     | SC-88/SC70-6/SOT-363 | PAGE 1 OF 2  |

ON Semiconductor and are trademarks of Semiconductor Components Industries, LLC dba ON Semiconductor or its subsidiaries in the United States and/or other countries. ON Semiconductor reserves the right to make changes without further notice to any products herein. ON Semiconductor makes no warranty, representation or guarantee regarding the suitability of its products for any particular purpose, nor does ON Semiconductor assume any liability arising out of the application or use of any product or circuit, and specifically disclaims any and all liability, including without limitation special, consequential or incidental damages. ON Semiconductor does not convey any license under its patent rights nor the rights of others.

**SC-88/SC70-6/SOT-363**  
**CASE 419B-02**  
**ISSUE Y**

DATE 11 DEC 2012

|   |   |  |  |  |  |
|---|---|--|--|--|--|
| <b>STYLE 1:</b><br>PIN 1. EMITTER 2<br>2. BASE 2<br>3. COLLECTOR 1<br>4. EMITTER 1<br>5. BASE 1<br>6. COLLECTOR 2 | <b>STYLE 2:</b><br>CANCELLED  | <b>STYLE 3:</b><br>CANCELLED   | <b>STYLE 4:</b><br>PIN 1. CATHODE<br>2. CATHODE<br>3. COLLECTOR<br>4. EMITTER<br>5. BASE<br>6. ANODE               | <b>STYLE 5:</b><br>PIN 1. ANODE<br>2. ANODE<br>3. COLLECTOR<br>4. EMITTER<br>5. BASE<br>6. CATHODE                 | <b>STYLE 6:</b><br>PIN 1. ANODE 2<br>2. N/C<br>3. CATHODE 1<br>4. ANODE 1<br>5. N/C<br>6. CATHODE 2          |
| <b>STYLE 7:</b><br>PIN 1. SOURCE 2<br>2. DRAIN 2<br>3. GATE 1<br>4. SOURCE 1<br>5. DRAIN 1<br>6. GATE 2           | <b>STYLE 8:</b><br>CANCELLED  | <b>STYLE 9:</b><br>PIN 1. EMITTER 2<br>2. EMITTER 1<br>3. COLLECTOR 1<br>4. BASE 1<br>5. BASE 2<br>6. COLLECTOR 2  | <b>STYLE 10:</b><br>PIN 1. SOURCE 2<br>2. SOURCE 1<br>3. GATE 1<br>4. DRAIN 1<br>5. DRAIN 2<br>6. GATE 2           | <b>STYLE 11:</b><br>PIN 1. CATHODE 2<br>2. CATHODE 2<br>3. ANODE 1<br>4. CATHODE 1<br>5. CATHODE 1<br>6. ANODE 2   | <b>STYLE 12:</b><br>PIN 1. ANODE 2<br>2. ANODE 2<br>3. CATHODE 1<br>4. ANODE 1<br>5. ANODE 1<br>6. CATHODE 2 |
| <b>STYLE 13:</b><br>PIN 1. ANODE<br>2. N/C<br>3. COLLECTOR<br>4. EMITTER<br>5. BASE<br>6. CATHODE                 | <b>STYLE 14:</b><br>PIN 1. VREF<br>2. GND<br>3. GND<br>4. IOUT<br>5. VEN<br>6. VCC                            | <b>STYLE 15:</b><br>PIN 1. ANODE 1<br>2. ANODE 2<br>3. ANODE 3<br>4. CATHODE 3<br>5. CATHODE 2<br>6. CATHODE 1     | <b>STYLE 16:</b><br>PIN 1. BASE 1<br>2. EMITTER 2<br>3. COLLECTOR 2<br>4. BASE 2<br>5. EMITTER 1<br>6. COLLECTOR 1 | <b>STYLE 17:</b><br>PIN 1. BASE 1<br>2. EMITTER 1<br>3. COLLECTOR 2<br>4. BASE 2<br>5. EMITTER 2<br>6. COLLECTOR 1 | <b>STYLE 18:</b><br>PIN 1. VIN1<br>2. VCC<br>3. VOUT2<br>4. VIN2<br>5. GND<br>6. VOUT1                       |
| <b>STYLE 19:</b><br>PIN 1. IOUT<br>2. GND<br>3. GND<br>4. V CC<br>5. V EN<br>6. V REF                             | <b>STYLE 20:</b><br>PIN 1. COLLECTOR<br>2. COLLECTOR<br>3. BASE<br>4. EMITTER<br>5. COLLECTOR<br>6. COLLECTOR | <b>STYLE 21:</b><br>PIN 1. ANODE 1<br>2. N/C<br>3. ANODE 2<br>4. CATHODE 2<br>5. N/C<br>6. CATHODE 1               | <b>STYLE 22:</b><br>PIN 1. D1 (i)<br>2. GND<br>3. D2 (i)<br>4. D2 (c)<br>5. VBUS<br>6. D1 (c)                      | <b>STYLE 23:</b><br>PIN 1. Vn<br>2. CH1<br>3. Vp<br>4. N/C<br>5. CH2<br>6. N/C                                     | <b>STYLE 24:</b><br>PIN 1. CATHODE<br>2. ANODE<br>3. CATHODE<br>4. CATHODE<br>5. CATHODE<br>6. CATHODE       |
| <b>STYLE 25:</b><br>PIN 1. BASE 1<br>2. CATHODE<br>3. COLLECTOR 2<br>4. BASE 2<br>5. EMITTER<br>6. COLLECTOR 1    | <b>STYLE 26:</b><br>PIN 1. SOURCE 1<br>2. GATE 1<br>3. DRAIN 2<br>4. SOURCE 2<br>5. GATE 2<br>6. DRAIN 1      | <b>STYLE 27:</b><br>PIN 1. BASE 2<br>2. BASE 1<br>3. COLLECTOR 1<br>4. EMITTER 1<br>5. EMITTER 2<br>6. COLLECTOR 2 | <b>STYLE 28:</b><br>PIN 1. DRAIN<br>2. DRAIN<br>3. GATE<br>4. SOURCE<br>5. DRAIN<br>6. DRAIN                       | <b>STYLE 29:</b><br>PIN 1. ANODE<br>2. ANODE<br>3. COLLECTOR<br>4. EMITTER<br>5. BASE/ANODE<br>6. CATHODE          | <b>STYLE 30:</b><br>PIN 1. SOURCE 1<br>2. DRAIN 2<br>3. DRAIN 2<br>4. SOURCE 2<br>5. GATE 1<br>6. DRAIN 1    |

Note: Please refer to datasheet for style callout. If style type is not called out in the datasheet refer to the device datasheet pinout or pin assignment.

|                         |                             |  |
|-------------------------|-----------------------------|--|
| <b>DOCUMENT NUMBER:</b> | <b>98ASB42985B</b>          | Electronic versions are uncontrolled except when accessed directly from the Document Repository. Printed versions are uncontrolled except when stamped "CONTROLLED COPY" in red. |
| <b>DESCRIPTION:</b>     | <b>SC-88/SC70-6/SOT-363</b> | <b>PAGE 2 OF 2</b>   |

ON Semiconductor and  are trademarks of Semiconductor Components Industries, LLC dba ON Semiconductor or its subsidiaries in the United States and/or other countries. ON Semiconductor reserves the right to make changes without further notice to any products herein. ON Semiconductor makes no warranty, representation or guarantee regarding the suitability of its products for any particular purpose, nor does ON Semiconductor assume any liability arising out of the application or use of any product or circuit, and specifically disclaims any and all liability, including without limitation special, consequential or incidental damages. ON Semiconductor does not convey any license under its patent rights nor the rights of others.

**onsemi**, **Onsemi**, and other names, marks, and brands are registered and/or common law trademarks of Semiconductor Components Industries, LLC dba "**onsemi**" or its affiliates and/or subsidiaries in the United States and/or other countries. **onsemi** owns the rights to a number of patents, trademarks, copyrights, trade secrets, and other intellectual property. A listing of **onsemi**'s product/patent coverage may be accessed at [www.onsemi.com/site/pdf/Patent-Marking.pdf](http://www.onsemi.com/site/pdf/Patent-Marking.pdf). **onsemi** reserves the right to make changes at any time to any products or information herein, without notice. The information herein is provided "as-is" and **onsemi** makes no warranty, representation or guarantee regarding the accuracy of the information, product features, availability, functionality, or suitability of its products for any particular purpose, nor does **onsemi** assume any liability arising out of the application or use of any product or circuit, and specifically disclaims any and all liability, including without limitation special, consequential or incidental damages. Buyer is responsible for its products and applications using **onsemi** products, including compliance with all laws, regulations and safety requirements or standards, regardless of any support or applications information provided by **onsemi**. "Typical" parameters which may be provided in **onsemi** data sheets and/or specifications can and do vary in different applications and actual performance may vary over time. All operating parameters, including "Typicals" must be validated for each customer application by customer's technical experts. **onsemi** does not convey any license under any of its intellectual property rights nor the rights of others. **onsemi** products are not designed, intended, or authorized for use as a critical component in life support systems or any FDA Class 3 medical devices or medical devices with a same or similar classification in a foreign jurisdiction or any devices intended for implantation in the human body. Should Buyer purchase or use **onsemi** products for any such unintended or unauthorized application, Buyer shall indemnify and hold **onsemi** and its officers, employees, subsidiaries, affiliates, and distributors harmless against all claims, costs, damages, and expenses, and reasonable attorney fees arising out of, directly or indirectly, any claim of personal injury or death associated with such unintended or unauthorized use, even if such claim alleges that **onsemi** was negligent regarding the design or manufacture of the part. **onsemi** is an Equal Opportunity/Affirmative Action Employer. This literature is subject to all applicable copyright laws and is not for resale in any manner.

## PUBLICATION ORDERING INFORMATION

### LITERATURE FULFILLMENT:

Email Requests to: [orderlit@onsemi.com](mailto:orderlit@onsemi.com)

**onsemi Website:** [www.onsemi.com](http://www.onsemi.com)

### TECHNICAL SUPPORT

**North American Technical Support:**

Voice Mail: 1 800-282-9855 Toll Free USA/Canada

Phone: 011 421 33 790 2910

**Europe, Middle East and Africa Technical Support:**

Phone: 00421 33 790 2910

For additional information, please contact your local Sales Representative