

NTD65N03R

Power MOSFET 25 V, 65 A, Single N-Channel, DPAK

Features

- Low $R_{DS(on)}$
- Ultra Low Gate Charge
- Low Reverse Recovery Charge
- Pb-Free Packages are Available

Applications

- Desktop CPU Power
- DC-DC Converters
- High and Low Side Switch

MAXIMUM RATINGS ($T_J = 25^\circ\text{C}$ unless otherwise noted)

Parameter	Symbol	Value	Unit	
Drain-to-Source Voltage	V_{DSS}	25	V	
Gate-to-Source Voltage	V_{GS}	± 20	V	
Continuous Drain Current ($R_{\theta JC}$) Limited by Die	I_D	$T_C = 25^\circ\text{C}$	65	A
		$T_C = 85^\circ\text{C}$	45	A
Continuous Drain Current ($R_{\theta JC}$) Limited by Wire	I_D	$T_C = 25^\circ\text{C}$	32	A
		$T_C = 25^\circ\text{C}$	P_D	50
Power Dissipation ($R_{\theta JC}$)				
Continuous Drain Current (Note 1)	I_D	$T_A = 25^\circ\text{C}$	11.4	A
		$T_A = 85^\circ\text{C}$	8.9	A
Power Dissipation (Note 1)	P_D	1.88	W	
Continuous Drain Current (Note 2)	I_D	$T_A = 25^\circ\text{C}$	9.5	A
		$T_A = 85^\circ\text{C}$	7.4	A
Power Dissipation (Note 2)	P_D	1.3	W	
Pulsed Drain Current	$t_p = 10 \mu\text{s}$	I_{DM}	130	A
Operating Junction and Storage Temperature	T_J, T_{stg}	-55 to 175	$^\circ\text{C}$	
Drain-to-Source (dv/dt)	dv/dt	2.0	V/ns	
Source Current (Body Diode)	I_S	2.1	A	
Single Pulse Drain-to-Source Avalanche Energy ($V_{DD} = 24 \text{ V}, V_{GS} = 10 \text{ V}, I_L = 12 \text{ A}, L = 1.0 \text{ mH}, R_G = 25 \Omega$)	E_{AS}	71.7	mJ	
Lead Temperature for Soldering Purposes (1/8" from case for 10 s)	T_L	260	$^\circ\text{C}$	

Stresses exceeding Maximum Ratings may damage the device. Maximum Ratings are stress ratings only. Functional operation above the Recommended Operating Conditions is not implied. Extended exposure to stresses above the Recommended Operating Conditions may affect device reliability.

1. Surface-mounted on FR4 board using 1 in sq pad size (Cu area = 1.127 in sq [1 oz] including traces).
2. Surface-mounted on FR4 board using the minimum recommended pad size (Cu area = 0.15 in sq [1 oz] including traces).



ON Semiconductor®

<http://onsemi.com>

$V_{(BR)DSS}$	$R_{DS(on)}$ TYP	I_D MAX
25 V	6.5 m Ω @ 10 V	65 A
	9.7 m Ω @ 4.5 V	

N-Channel

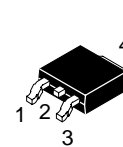
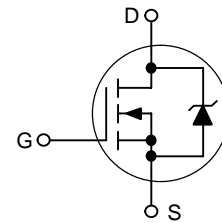

CASE 369AA
DPAK
(Bend Lead)
STYLE 2

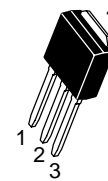

CASE 369D
DPAK
(Straight Lead)
STYLE 2

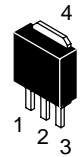

CASE 369AC
3 IPAK
(Straight Lead)

MARKING DIAGRAMS & PIN ASSIGNMENTS

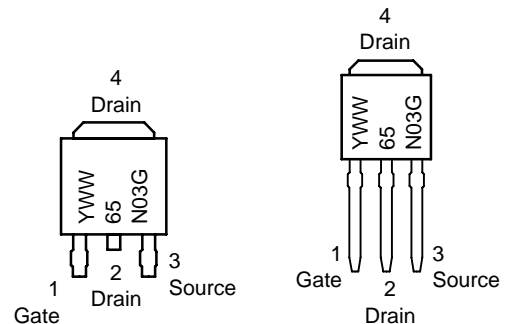

Y = Year
 WW = Work Week
 65N03 = Device Code
 G = Pb-Free Package

ORDERING INFORMATION

See detailed ordering and shipping information in the package dimensions section on page 5 of this data sheet.

NTD65N03R

THERMAL RESISTANCE MAXIMUM RATINGS

Parameter	Symbol	Value	Unit
Junction-to-Case (Drain)	$R_{\theta JC}$	2.5	°C/W
Junction-to-Ambient – Steady State (Note 3)	$R_{\theta JA}$	80	
Junction-to-Ambient – Steady State (Note 4)	$R_{\theta JA}$	115	

ELECTRICAL CHARACTERISTICS ($T_J = 25^\circ\text{C}$ unless otherwise noted)

Parameter	Symbol	Test Condition	Min	Typ	Max	Unit
-----------	--------	----------------	-----	-----	-----	------

OFF CHARACTERISTICS

Drain-to-Source Breakdown Voltage	$V_{(BR)DSS}$	$V_{GS} = 0\text{ V}, I_D = 250\ \mu\text{A}$	25	29.5		V
Drain-to-Source Breakdown Voltage Temperature Coefficient	$V_{(BR)DSS}/T_J$			19.2		mV/°C
Zero Gate Voltage Drain Current	I_{DSS}	$V_{GS} = 0\text{ V}, V_{DS} = 20\text{ V}$	$T_J = 25^\circ\text{C}$		1.5	μA
			$T_J = 125^\circ\text{C}$		10	
Gate-to-Source Leakage Current	I_{GSS}	$V_{DS} = 0\text{ V}, V_{GS} = \pm 20\text{ V}$			± 100	nA

ON CHARACTERISTICS (Note 5)

Gate Threshold Voltage	$V_{GS(TH)}$	$V_{GS} = V_{DS}, I_D = 250\ \mu\text{A}$	1.0	1.74	2.0	V
Negative Threshold Temperature Coefficient	$V_{GS(TH)}/T_J$			4.8		mV/°C
Drain-to-Source On Resistance	$R_{DS(on)}$	$V_{GS} = 10\text{ V}, I_D = 30\text{ A}$		6.5	8.4	$\text{m}\Omega$
		$V_{GS} = 4.5\text{ V}, I_D = 30\text{ A}$		9.7	14.6	
Forward Transconductance	g_{FS}	$V_{DS} = 15\text{ V}, I_D = 15\text{ A}$		27		mHos

CHARGES, CAPACITANCES AND GATE RESISTANCE

Input Capacitance	C_{iss}	$V_{GS} = 0\text{ V}, f = 1.0\text{ MHz}, V_{DS} = 20\text{ V}$		1177	1400	pF
Output Capacitance	C_{oss}			555		
Reverse Transfer Capacitance	C_{rss}			218		
Total Gate Charge	$Q_{G(TOT)}$	$V_{GS} = 5.0\text{ V}, V_{DS} = 10\text{ V}, I_D = 30\text{ A}$		12.2	16	nC
Threshold Gate Charge	$Q_{G(TH)}$			1.5		
Gate-to-Source Charge	Q_{GS}			2.95		
Gate-to-Drain Charge	Q_{GD}			6.08		

SWITCHING CHARACTERISTICS (Note 6)

Turn-On Delay Time	$t_{d(on)}$	$V_{GS} = 10\text{ V}, V_{DS} = 25\text{ V}, I_D = 30\text{ A}, R_G = 3.0\ \Omega$		6.3		ns
Rise Time	t_r			18.6		
Turn-Off Delay Time	$t_{d(off)}$			20.3		
Fall Time	t_f			8.8		

DRAIN-SOURCE DIODE CHARACTERISTICS

Forward Diode Voltage	V_{SD}	$V_{GS} = 0\text{ V}, I_S = 20\text{ A}$	$T_J = 25^\circ\text{C}$	0.85	1.1	V
			$T_J = 125^\circ\text{C}$	0.72		
Reverse Recovery Time	t_{RR}	$V_{GS} = 0\text{ V}, di_S/dt = 100\text{ A}/\mu\text{s}, I_S = 20\text{ A}$		28.8		ns
Charge Time	t_a			12.8		
Discharge Time	t_b			16		
Reverse Recovery Time	Q_{RR}			20		nC

PACKAGE PARASITIC VALUES

Source Inductance	L_S	$T_A = 25^\circ\text{C}$		2.49		nH
Drain Inductance	L_D			0.02		
Gate Inductance	L_G			3.46		
Gate Resistance	R_G			1.75		

- Surface-mounted on FR4 board using 1 in sq pad size (Cu area = 1.127 in sq [1 oz] including traces).
- Surface-mounted on FR4 board using the minimum recommended pad size (Cu area = 0.15 in sq [1 oz] including traces).
- Pulse Test: Pulse Width $\leq 300\ \mu\text{s}$, Duty Cycle $\leq 2\%$.
- Switching characteristics are independent of operating junction temperatures.

NTD65N03R

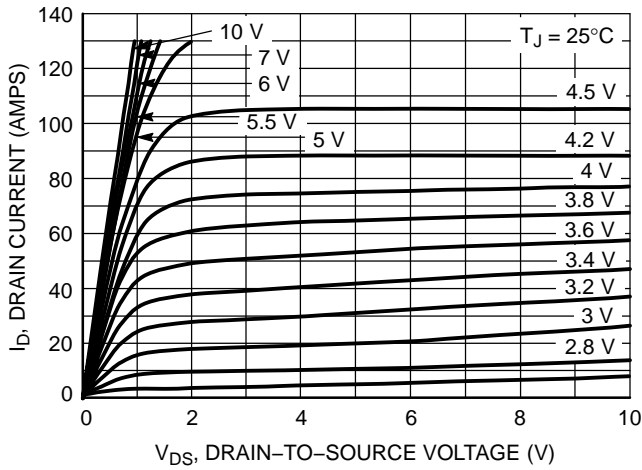

Figure 1. On-Region Characteristics

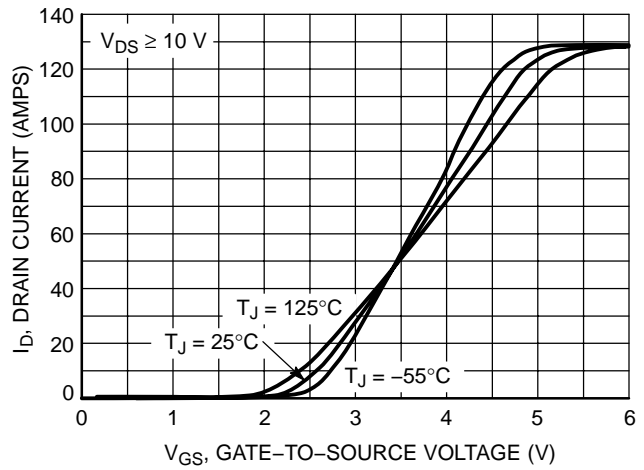

Figure 2. Transfer Characteristics

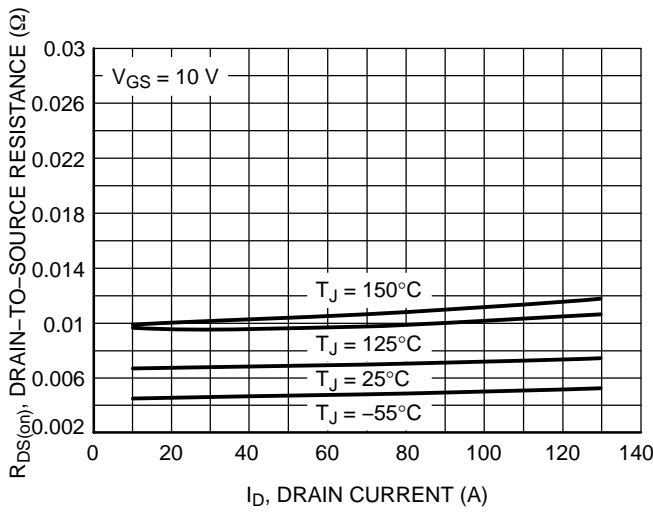

Figure 3. On-Resistance versus Drain Current and Temperature

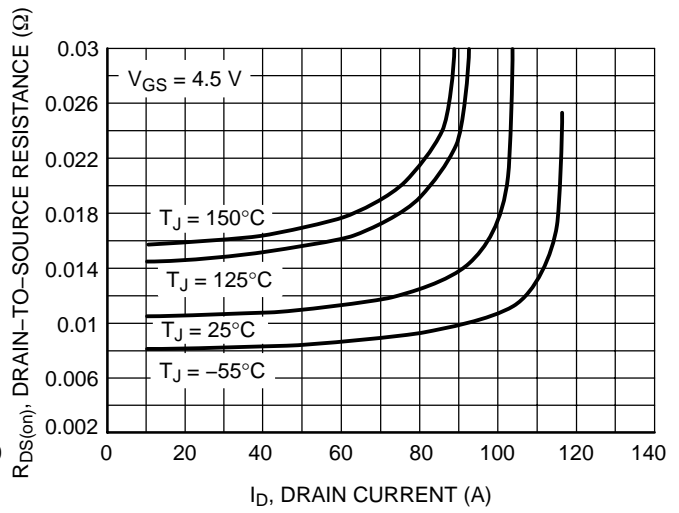

Figure 4. On-Resistance versus Drain Current and Temperature

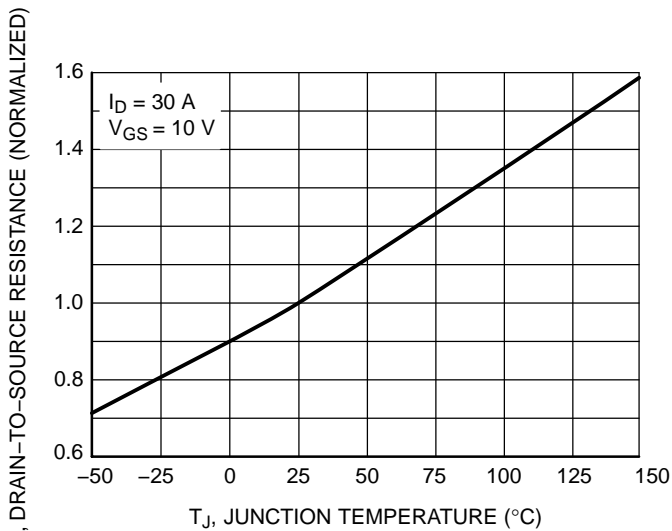

Figure 5. On-Resistance Variation with Temperature

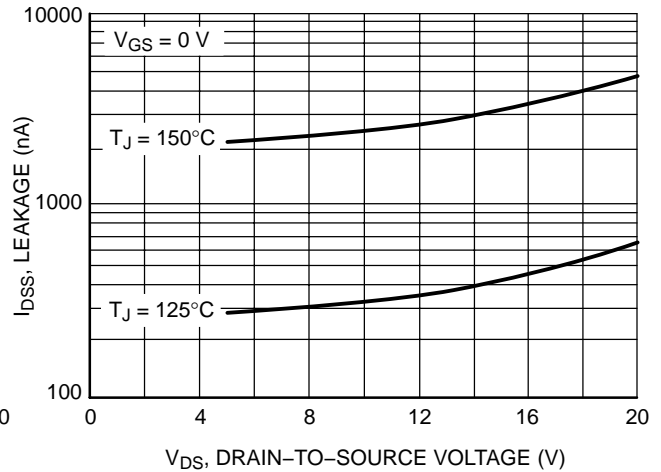

Figure 6. Drain-to-Source Leakage Current versus Voltage

NTD65N03R

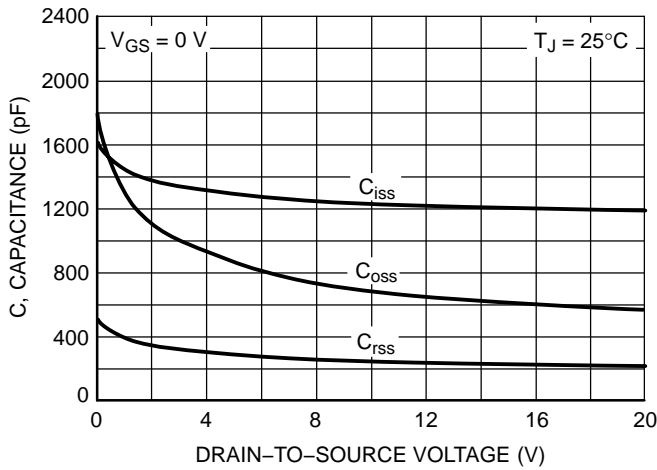

Figure 7. Capacitance Variation

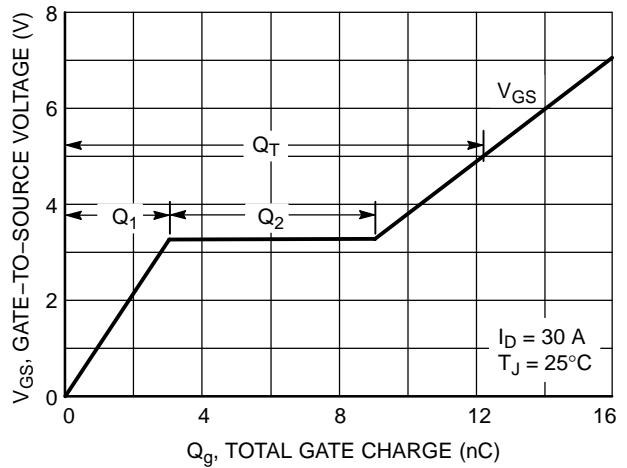

Figure 8. Gate-to-Source and Drain-to-Source Voltage versus Total Charge

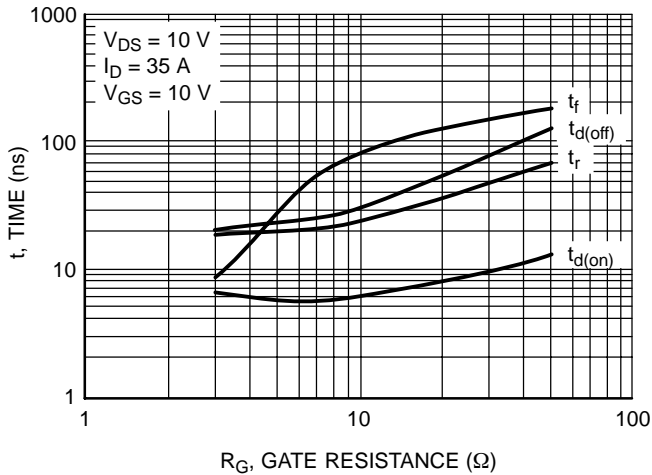

Figure 9. Resistive Switching Time Variation versus Gate Resistance

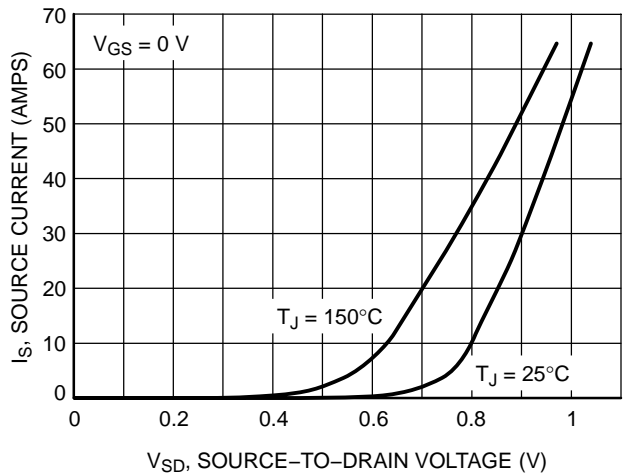

Figure 10. Diode Forward Voltage versus Current

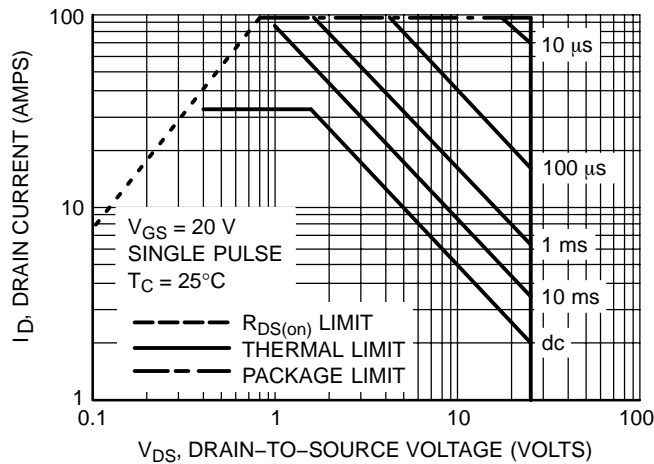

Figure 11. Maximum Rated Forward Biased Safe Operating Area

NTD65N03R

ORDERING INFORMATION

Order Number	Package	Shipping†
NTD65N03R	DPAK-3	75 Units / Rail
NTD65N03RG	DPAK-3 (Pb-Free)	75 Units / Rail
NTD65N03RT4	DPAK-3	2500 / Tape & Reel
NTD65N03RT4G	DPAK-3 (Pb-Free)	2500 / Tape & Reel
NTD65N03R-1	DPAK-3 Straight Lead	75 Units / Rail
NTD65N03R-1G	DPAK-3 Straight Lead (Pb-Free)	75 Units / Rail
NTD65N03R-35	DPAK Straight Lead Trimmed (3.5 ± 0.15 mm)	75 Units / Rail
NTD65N03R-35G	DPAK Straight Lead Trimmed (3.5 ± 0.15 mm) (Pb-Free)	75 Units / Rail

†For information on tape and reel specifications, including part orientation and tape sizes, please refer to our Tape and Reel Packaging Specifications Brochure, BRD8011/D.

MECHANICAL CASE OUTLINE

PACKAGE DIMENSIONS

ON Semiconductor®



IPAK CASE 369D-01 ISSUE C

DATE 15 DEC 2010

SCALE 1:1



NOTES:

1. DIMENSIONING AND TOLERANCING PER ANSI Y14.5M, 1982.
2. CONTROLLING DIMENSION: INCH.

DIM	INCHES		MILLIMETERS	
	MIN	MAX	MIN	MAX
A	0.235	0.245	5.97	6.35
B	0.250	0.265	6.35	6.73
C	0.086	0.094	2.19	2.38
D	0.027	0.035	0.69	0.88
E	0.018	0.023	0.46	0.58
F	0.037	0.045	0.94	1.14
G	0.090	BSC	2.29	BSC
H	0.034	0.040	0.87	1.01
J	0.018	0.023	0.46	0.58
K	0.350	0.380	8.89	9.65
R	0.180	0.215	4.45	5.45
S	0.025	0.040	0.63	1.01
V	0.035	0.050	0.89	1.27
Z	0.155	---	3.93	---

- STYLE 1:
PIN 1. BASE
2. COLLECTOR
3. EMITTER
4. COLLECTOR
- STYLE 2:
PIN 1. GATE
2. DRAIN
3. SOURCE
4. DRAIN
- STYLE 3:
PIN 1. ANODE
2. CATHODE
3. ANODE
4. CATHODE
- STYLE 4:
PIN 1. CATHODE
2. ANODE
3. GATE
4. ANODE
- STYLE 5:
PIN 1. GATE
2. ANODE
3. CATHODE
4. ANODE
- STYLE 6:
PIN 1. MT1
2. MT2
3. GATE
4. MT2
- STYLE 7:
PIN 1. GATE
2. COLLECTOR
3. EMITTER
4. COLLECTOR

MARKING DIAGRAMS

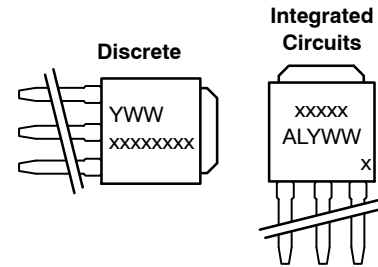

- xxxxxxxxx = Device Code
A = Assembly Location
IL = Wafer Lot
Y = Year
WW = Work Week

DOCUMENT NUMBER:	98AON10528D	Electronic versions are uncontrolled except when accessed directly from the Document Repository. Printed versions are uncontrolled except when stamped "CONTROLLED COPY" in red.
DESCRIPTION:	IPAK (DPAK INSERTION MOUNT)	PAGE 1 OF 1

ON Semiconductor and are trademarks of Semiconductor Components Industries, LLC dba ON Semiconductor or its subsidiaries in the United States and/or other countries. ON Semiconductor reserves the right to make changes without further notice to any products herein. ON Semiconductor makes no warranty, representation or guarantee regarding the suitability of its products for any particular purpose, nor does ON Semiconductor assume any liability arising out of the application or use of any product or circuit, and specifically disclaims any and all liability, including without limitation special, consequential or incidental damages. ON Semiconductor does not convey any license under its patent rights nor the rights of others.

MECHANICAL CASE OUTLINE

PACKAGE DIMENSIONS

ON Semiconductor®



SCALE 1:1

DPAK (SINGLE GAUGE)

CASE 369AA-01

ISSUE B

DATE 03 JUN 2010



NOTES:

- DIMENSIONING AND TOLERANCING PER ASME Y14.5M, 1994.
- CONTROLLING DIMENSION: INCHES.
- THERMAL PAD CONTOUR OPTIONAL WITHIN DIMENSIONS b3, L3 and Z.
- DIMENSIONS D AND E DO NOT INCLUDE MOLD FLASH, PROTRUSIONS, OR BURRS. MOLD FLASH, PROTRUSIONS, OR GATE BURRS SHALL NOT EXCEED 0.006 INCHES PER SIDE.
- DIMENSIONS D AND E ARE DETERMINED AT THE OUTERMOST EXTREMES OF THE PLASTIC BODY.
- DATUMS A AND B ARE DETERMINED AT DATUM PLANE H.

DIM	INCHES		MILLIMETERS	
	MIN	MAX	MIN	MAX
A	0.086	0.094	2.18	2.38
A1	0.000	0.005	0.00	0.13
b	0.025	0.035	0.63	0.89
b2	0.030	0.045	0.76	1.14
b3	0.180	0.215	4.57	5.46
c	0.018	0.024	0.46	0.61
c2	0.018	0.024	0.46	0.61
D	0.235	0.245	5.97	6.22
E	0.250	0.265	6.35	6.73
e	0.090 BSC		2.29 BSC	
H	0.370	0.410	9.40	10.41
L	0.055	0.070	1.40	1.78
L1	0.108 REF		2.74 REF	
L2	0.020 BSC		0.51 BSC	
L3	0.035	0.050	0.89	1.27
L4	---	0.040	---	1.01
Z	0.155	---	3.93	---

- | | | | |
|--|---|--|--|
| <p>STYLE 1:
PIN 1. BASE
2. COLLECTOR
3. EMITTER
4. COLLECTOR</p> | <p>STYLE 2:
PIN 1. GATE
2. DRAIN
3. SOURCE
4. DRAIN</p> | <p>STYLE 3:
PIN 1. ANODE
2. CATHODE
3. ANODE
4. CATHODE</p> | <p>STYLE 4:
PIN 1. CATHODE
2. ANODE
3. GATE
4. ANODE</p> |
| <p>STYLE 5:
PIN 1. GATE
2. ANODE
3. CATHODE
4. ANODE</p> | <p>STYLE 6:
PIN 1. MT1
2. MT2
3. GATE
4. MT2</p> | <p>STYLE 7:
PIN 1. GATE
2. COLLECTOR
3. EMITTER
4. COLLECTOR</p> | |

GENERIC MARKING DIAGRAM*



IC Discrete

- XXXXXX = Device Code
- A = Assembly Location
- L = Wafer Lot
- Y = Year
- WW = Work Week
- G = Pb-Free Package

*This information is generic. Please refer to device data sheet for actual part marking.

SOLDERING FOOTPRINT*



SCALE 3:1 (mm/inches)

*For additional information on our Pb-Free strategy and soldering details, please download the ON Semiconductor Soldering and Mounting Techniques Reference Manual, SOLDERRM/D.

DOCUMENT NUMBER:	98AON13126D	Electronic versions are uncontrolled except when accessed directly from the Document Repository. Printed versions are uncontrolled except when stamped "CONTROLLED COPY" in red.
DESCRIPTION:	DPAK (SINGLE GAUGE)	PAGE 1 OF 1

ON Semiconductor and ON are trademarks of Semiconductor Components Industries, LLC dba ON Semiconductor or its subsidiaries in the United States and/or other countries. ON Semiconductor reserves the right to make changes without further notice to any products herein. ON Semiconductor makes no warranty, representation or guarantee regarding the suitability of its products for any particular purpose, nor does ON Semiconductor assume any liability arising out of the application or use of any product or circuit, and specifically disclaims any and all liability, including without limitation special, consequential or incidental damages. ON Semiconductor does not convey any license under its patent rights nor the rights of others.

onsemi, **Onsemi**, and other names, marks, and brands are registered and/or common law trademarks of Semiconductor Components Industries, LLC dba "**onsemi**" or its affiliates and/or subsidiaries in the United States and/or other countries. **onsemi** owns the rights to a number of patents, trademarks, copyrights, trade secrets, and other intellectual property. A listing of **onsemi**'s product/patent coverage may be accessed at www.onsemi.com/site/pdf/Patent-Marking.pdf. **onsemi** reserves the right to make changes at any time to any products or information herein, without notice. The information herein is provided "as-is" and **onsemi** makes no warranty, representation or guarantee regarding the accuracy of the information, product features, availability, functionality, or suitability of its products for any particular purpose, nor does **onsemi** assume any liability arising out of the application or use of any product or circuit, and specifically disclaims any and all liability, including without limitation special, consequential or incidental damages. Buyer is responsible for its products and applications using **onsemi** products, including compliance with all laws, regulations and safety requirements or standards, regardless of any support or applications information provided by **onsemi**. "Typical" parameters which may be provided in **onsemi** data sheets and/or specifications can and do vary in different applications and actual performance may vary over time. All operating parameters, including "Typicals" must be validated for each customer application by customer's technical experts. **onsemi** does not convey any license under any of its intellectual property rights nor the rights of others. **onsemi** products are not designed, intended, or authorized for use as a critical component in life support systems or any FDA Class 3 medical devices or medical devices with a same or similar classification in a foreign jurisdiction or any devices intended for implantation in the human body. Should Buyer purchase or use **onsemi** products for any such unintended or unauthorized application, Buyer shall indemnify and hold **onsemi** and its officers, employees, subsidiaries, affiliates, and distributors harmless against all claims, costs, damages, and expenses, and reasonable attorney fees arising out of, directly or indirectly, any claim of personal injury or death associated with such unintended or unauthorized use, even if such claim alleges that **onsemi** was negligent regarding the design or manufacture of the part. **onsemi** is an Equal Opportunity/Affirmative Action Employer. This literature is subject to all applicable copyright laws and is not for resale in any manner.

PUBLICATION ORDERING INFORMATION

LITERATURE FULFILLMENT:

Email Requests to: orderlit@onsemi.com

onsemi Website: www.onsemi.com

TECHNICAL SUPPORT

North American Technical Support:

Voice Mail: 1 800-282-9855 Toll Free USA/Canada

Phone: 011 421 33 790 2910

Europe, Middle East and Africa Technical Support:

Phone: 00421 33 790 2910

For additional information, please contact your local Sales Representative