

NSM3005NZ

Small Signal BJT and MOSFET

30 V, 500 mA, PNP BJT with 20 V, 224 mA, N-Channel MOSFET

Features

- These Devices are Pb-Free, Halogen Free/BFR Free and are RoHS Compliant

Typical Applications

- Portable Devices

Q1 MAXIMUM RATINGS ($T_J = 25^\circ\text{C}$ unless otherwise specified)

Parameter	Symbol	Value	Unit
Collector-Emitter Voltage	V_{CEO}	30	V
Collector-Base Voltage	V_{CBO}	40	V
Emitter-Base Voltage	V_{EBO}	5.0	V
Collector Current	I_C	500	mA
Base Current	I_B	50	mA

Q2 MAXIMUM RATINGS ($T_J = 25^\circ\text{C}$ unless otherwise specified)

Parameter	Symbol	Value	Unit		
Drain-to-Source Voltage	V_{DSS}	20	V		
Gate-to-Source Voltage	V_{GS}	± 8	V		
Continuous Drain Current (Note 1)	Steady State	$T_A = 25^\circ\text{C}$	I_D	224	mA
		$T_A = 85^\circ\text{C}$			
		$t \leq 5 \text{ s}$			
Pulsed Drain Current	$T_p = 10 \mu\text{s}$	I_{DM}	673	mA	
Source Current (Body Diode)		I_S	120	mA	

THERMAL CHARACTERISTICS

Parameter	Symbol	Value	Unit
Thermal Resistance Junction-to-Ambient (Note 1) Total Power Dissipation @ $T_A = 25^\circ\text{C}$	$R_{\theta JA}$ P_D	245 0.8	$^\circ\text{C/W}$ W
Operating Junction and Storage Temperature	T_J, T_{STG}	-55 to 150	$^\circ\text{C}$
Lead Temperature for Soldering Purposes (1/8" from case for 10 s)	T_L	260	$^\circ\text{C}$

Stresses exceeding those listed in the Maximum Ratings table may damage the device. If any of these limits are exceeded, device functionality should not be assumed, damage may occur and reliability may be affected.

1. Surface mounted on FR4 board using 1 in sq pad size (Cu. area = 1.127 in sq [1 oz] including traces).



ON Semiconductor®

www.onsemi.com

MARKING DIAGRAM



UDFN6
CASE 517AT
 $\mu\text{COOL}^{\text{TM}}$

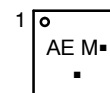

AE = Specific Device Code
M = Date Code
▪ = Pb-Free Package

(Note: Microdot may be in either location)
*Date Code orientation may vary depending upon manufacturing location.

PIN CONNECTIONS

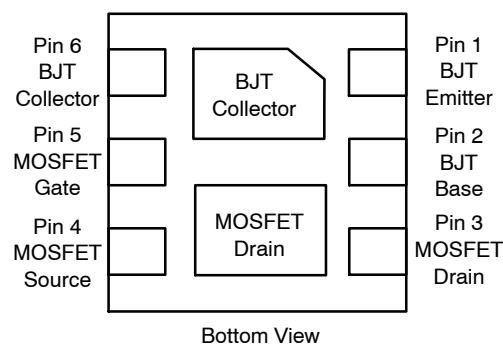
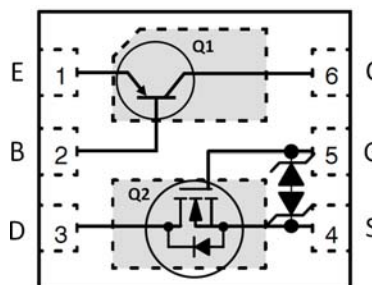

ORDERING INFORMATION

Device	Package	Shipping†
NSM3005NZTAG	UDFN6 (Pb-Free)	3000 / Tape & Reel

†For information on tape and reel specifications, including part orientation and tape sizes, please refer to our Tape and Reel Packaging Specifications Brochure, BRD8011/D.

NSM3005NZ

Q1 ELECTRICAL CHARACTERISTICS (T_J = 25°C unless otherwise specified)

Parameter	Symbol	Test Condition	Min	Typ	Max	Unit
OFF CHARACTERISTICS						
Collector–Base Breakdown Voltage	V _{(BR)CBO}	I _C = 100 μA	40	–	–	V
Collector–Emitter Breakdown Voltage	V _{(BR)CEO}	I _C = 10 mA	30	–	–	V
Emitter–Base Breakdown Voltage	V _{(BR)EBO}	I _E = 100 μA	5.0	–	–	V
Collector Cutoff Current	I _{CBO}	V _{CB} = 25 V, I _E = 0 A	–	–	1.0	μA
Emitter Cutoff Current	I _{EBO}	V _{EB} = 5.0 V, I _C = 0 A	–	–	10	μA
ON CHARACTERISTICS (Note 2)						
DC Current Gain	h _{FE}	V _{CE} = 3.0 V, I _C = 30 mA	20	–	100	
		V _{CE} = 3.0 V, I _C = 100 mA	20	–	100	
		V _{CE} = 3.0 V, I _C = 500 mA	20	–	100	
Collector–Emitter Saturation Voltage	V _{CE(sat)}	I _C = 500 mA, I _B = 50 mA	–	–	0.4	V
Base–Emitter Saturation Voltage	V _{BE(sat)}	I _C = 500 mA, I _B = 50 mA	–	–	1.1	V
Base–Emitter Turn–On Voltage	V _{BE(on)}	V _{CE} = 1.0 V, I _C = 500 mA	–	–	1.0	V

Q2 ELECTRICAL CHARACTERISTICS (T_J = 25°C unless otherwise specified)

Parameter	Symbol	Test Condition	Min	Typ	Max	Unit
OFF CHARACTERISTICS						
Drain–to–Source Breakdown Voltage	V _{(BR)DSS}	V _{GS} = 0 V, I _D = 250 μA	20	–	–	V
Drain–to–Source Breakdown Voltage Temperature Coefficient	V _{(BR)DSS} /T _J	I _D = –250 μA, ref to 25°C	–	19	–	mV/°C
Zero Gate Voltage Drain Current	I _{DSS}	V _{GS} = 0 V, V _{DS} = 16 V, T _J = 25°C	–	–	1.0	μA
Gate–to–Source Leakage Current	I _{GSS}	V _{DS} = 0 V, V _{GS} = ±8.0 V	–	–	±2.0	μA
ON CHARACTERISTICS (Note 2)						
Gate Threshold Voltage	V _{GS(TH)}	V _{GS} = V _{DS} , I _D = 250 μA	0.4	–	1.0	V
Negative Threshold Temperature Coefficient	V _{GS(TH)} /T _J	–	–	1.9	–	mV/°C
Drain–to–Source On Resistance	R _{DS(ON)}	V _{GS} = 4.5 V, I _D = 100 mA	–	0.65	1.4	Ω
		V _{GS} = 2.5 V, I _D = 50 mA	–	0.9	1.9	
		V _{GS} = 1.8 V, I _D = 20 mA	–	1.1	2.2	
		V _{GS} = 1.5 V, I _D = 10 mA	–	1.4	4.3	
Forward Transconductance	g _{FS}	V _{DS} = 5.0 V, I _D = 100 mA	–	0.56	–	S

CHARGES AND CAPACITANCES

Input Capacitance	C _{ISS}	f = 1.0 MHz, V _{GS} = 0 V, V _{DS} = 15 V	–	15.8	–	pF
Output Capacitance	C _{OSS}		–	3.5	–	
Reverse Transfer Capacitance	C _{RSS}		–	2.4	–	
Total Gate Charge	Q _{G(TOT)}	V _{GS} = 4.5 V, V _{DS} = 15 V; I _D = 200 mA	–	0.70	–	nC
Threshold Gate Charge	Q _{G(TH)}		–	0.05	–	
Gate–to–Source Charge	Q _{GS}		–	0.14	–	
Gate–to–Drain Charge	Q _{GD}		–	0.10	–	

SWITCHING CHARACTERISTICS, V_{GS} = 4.5 V (Note 3)

Turn–On Delay Time	t _{d(ON)}	V _{GS} = 4.5 V, V _{DD} = 15 V, I _D = 200 mA, R _G = 2 Ω	–	18	–	ns
Rise Time	t _r		–	35	–	
Turn–Off Delay Time	T _{d(OFF)}		–	201	–	
Fall Time	t _f		–	110	–	

DRAIN–SOURCE DIODE CHARACTERISTICS

Forward Diode Voltage	V _{SD}	V _{GS} = 0 V, I _S = 10 mA	–	0.55	1.0	V
-----------------------	-----------------	---	---	------	-----	---

2. Pulsed Condition: Pulse Width = 300 msec, Duty Cycle ≤ 2%.

3. Switching characteristics are independent of operating junction temperatures.

N5M3005NZ

TYPICAL CHARACTERISTICS – Q1

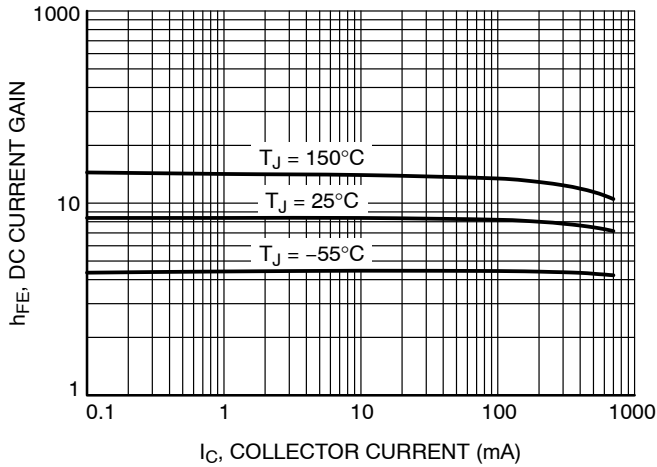

Figure 1. PNP DC Current Gain vs. Collector Current

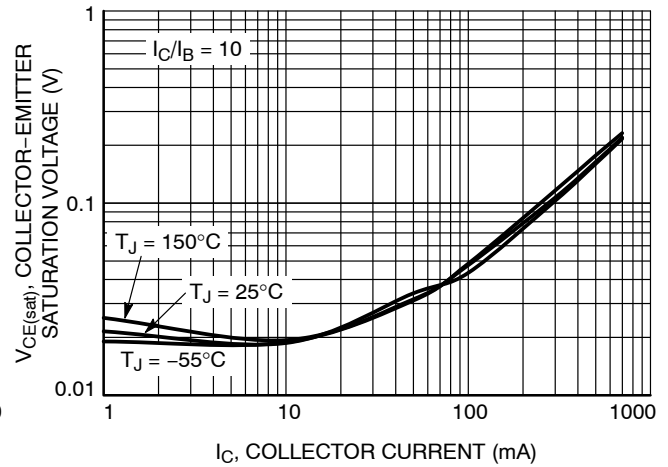

Figure 2. PNP VCE vs. IC

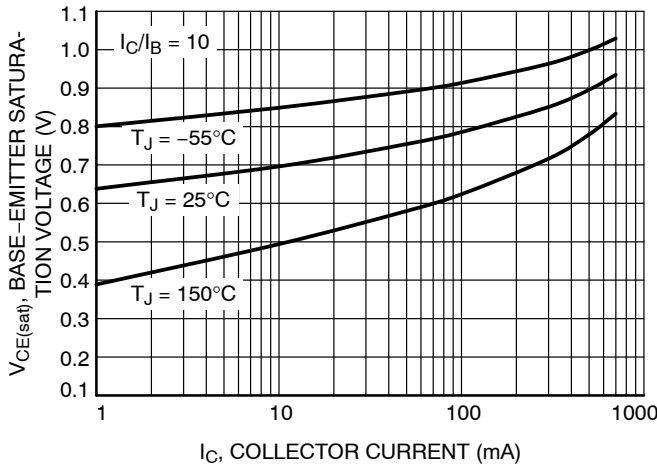

Figure 3. PNP VBE(sat) vs. IC

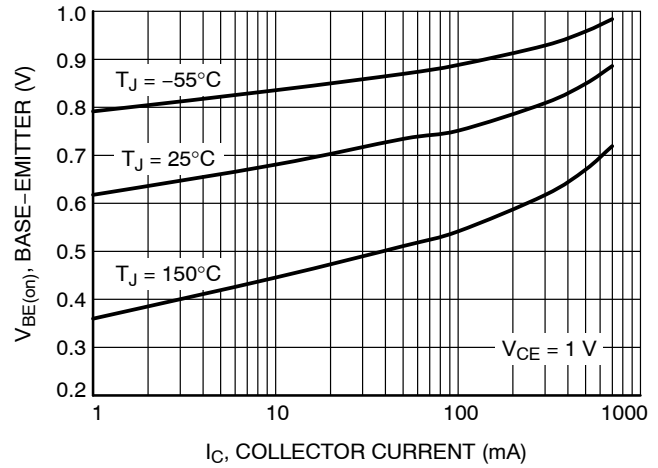

Figure 4. PNP VBE(on) vs. IC

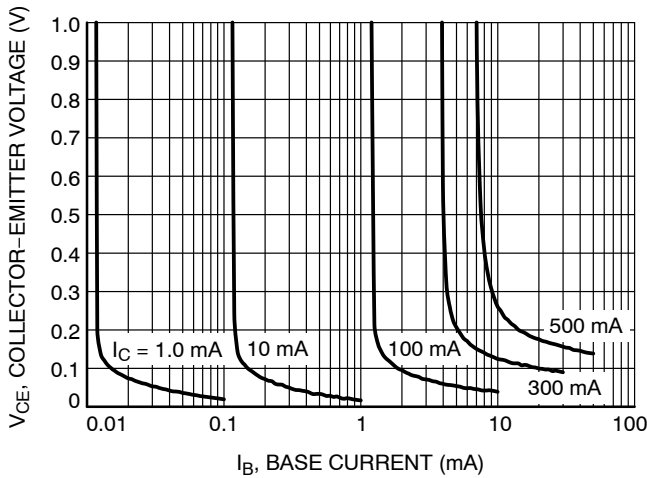

Figure 5. PNP VCE vs. IB

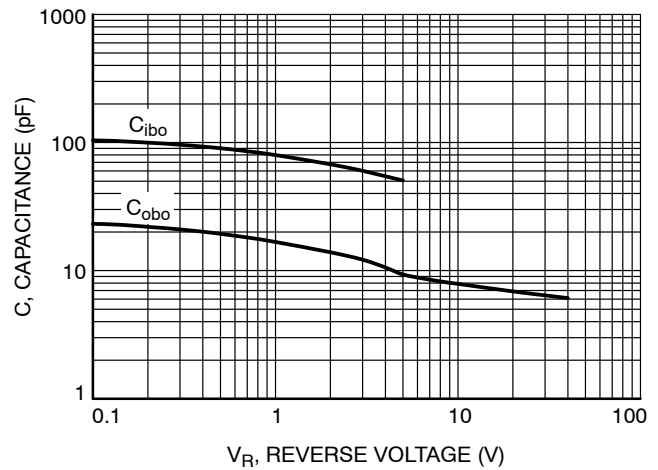

Figure 6. PNP Capacitance

NSM3005NZ

TYPICAL CHARACTERISTICS – Q2

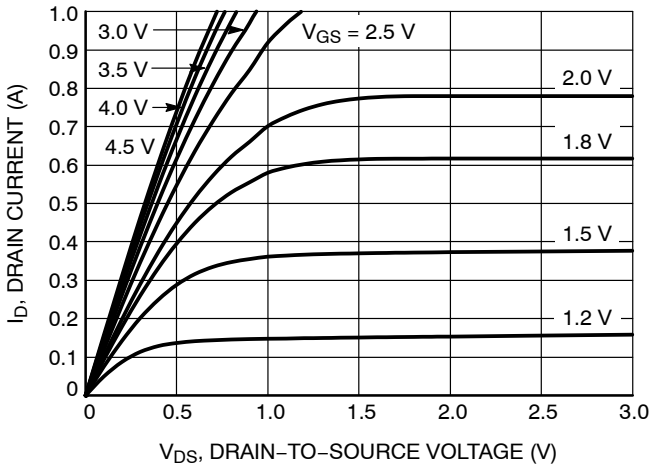

Figure 7. On-Region Characteristics

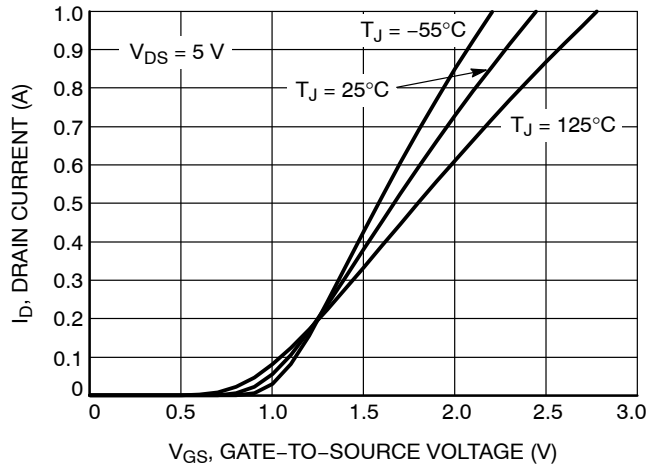

Figure 8. Transfer Characteristics

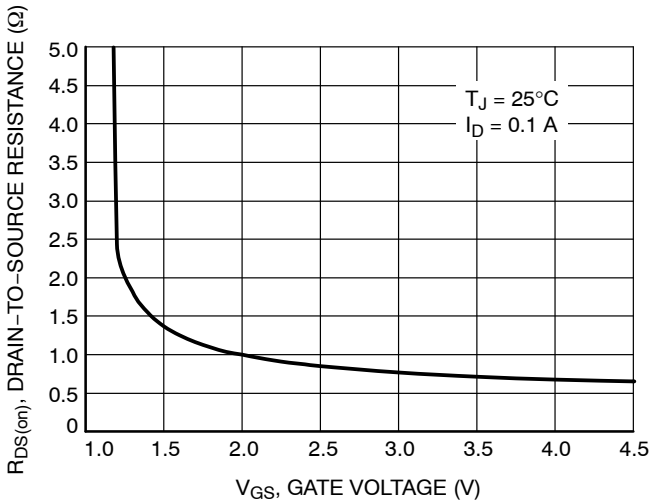

Figure 9. On-Resistance vs. Gate-to-Source Voltage

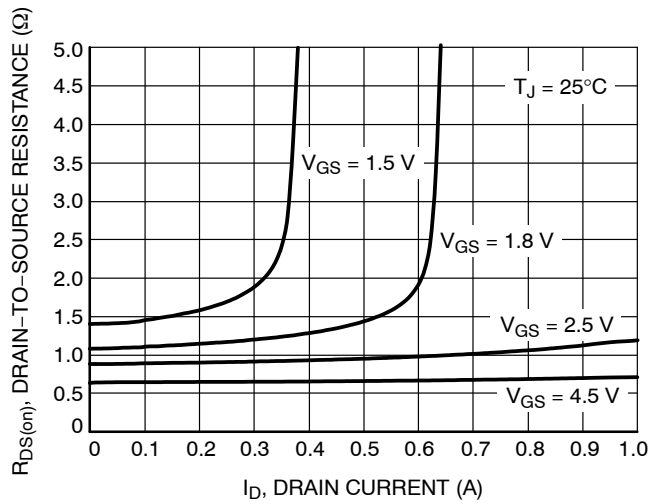

Figure 10. On-Resistance vs. Drain Current and Gate Voltage

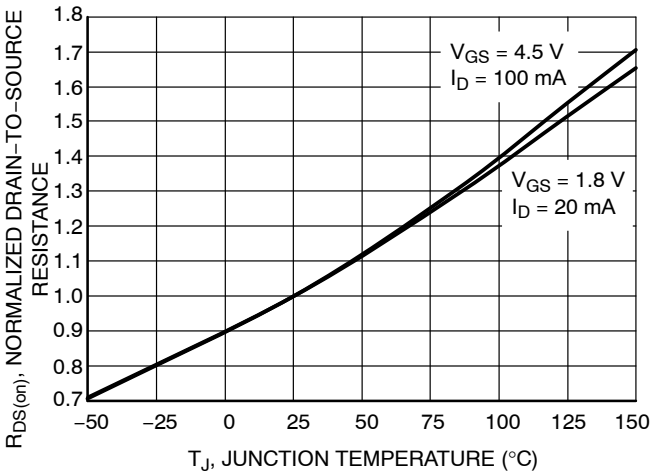

Figure 11. On-Resistance Variation with Temperature

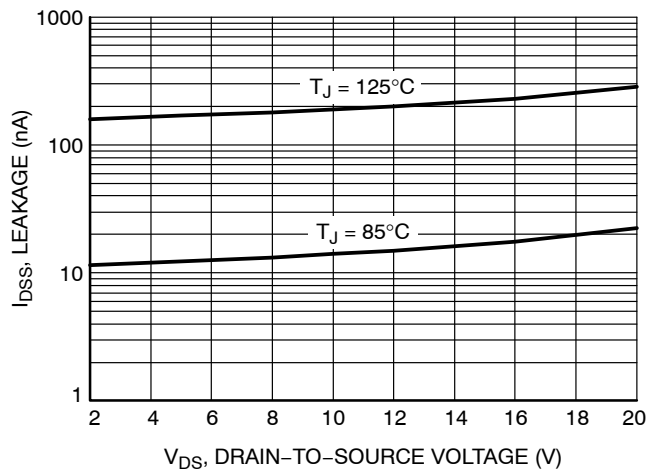

Figure 12. Drain-to-Source Leakage Current vs. Voltage

NSM3005NZ

TYPICAL CHARACTERISTICS – Q2

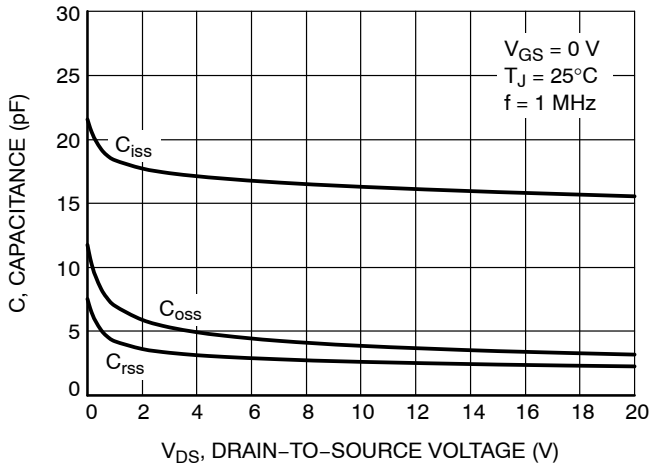

Figure 13. Capacitance Variation

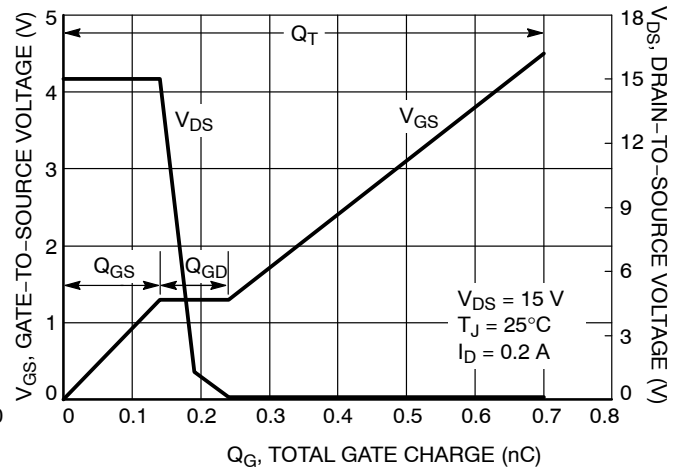

Figure 14. Gate-to-Source and Drain-to-Source Voltage vs. Total Charge

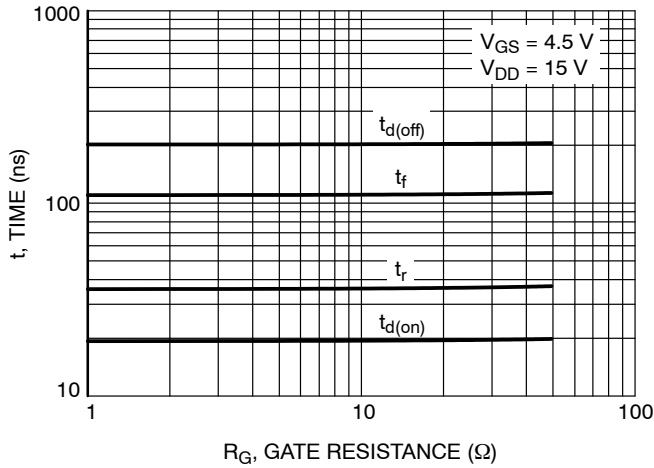

Figure 15. Resistive Switching Time Variation vs. Gate Resistance

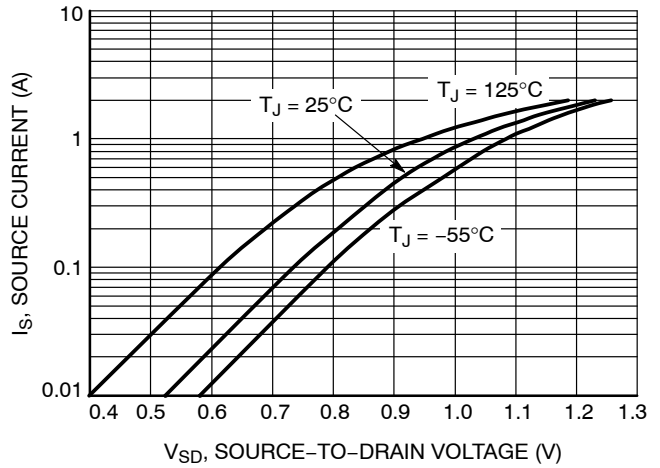

Figure 16. Diode Forward Voltage vs. Current

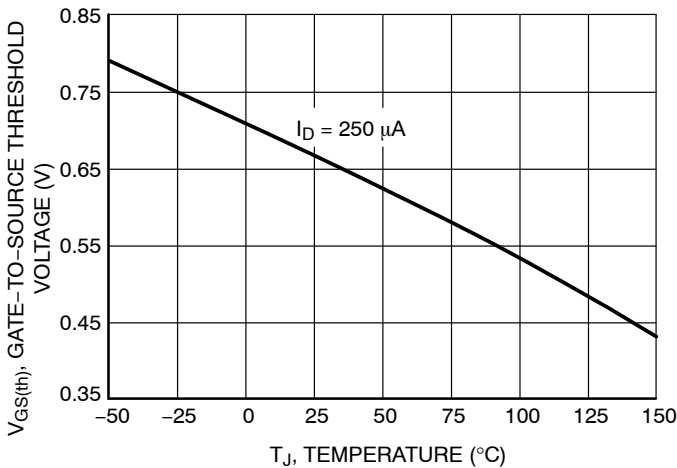

Figure 17. Threshold Voltage

MECHANICAL CASE OUTLINE

PACKAGE DIMENSIONS



UDFN6 1.6x1.6, 0.5P

CASE 517AT-01
ISSUE O

DATE 02 SEP 2008

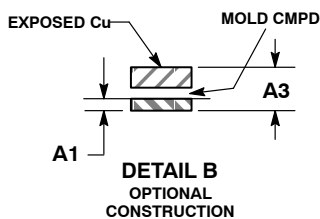
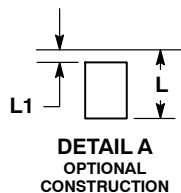
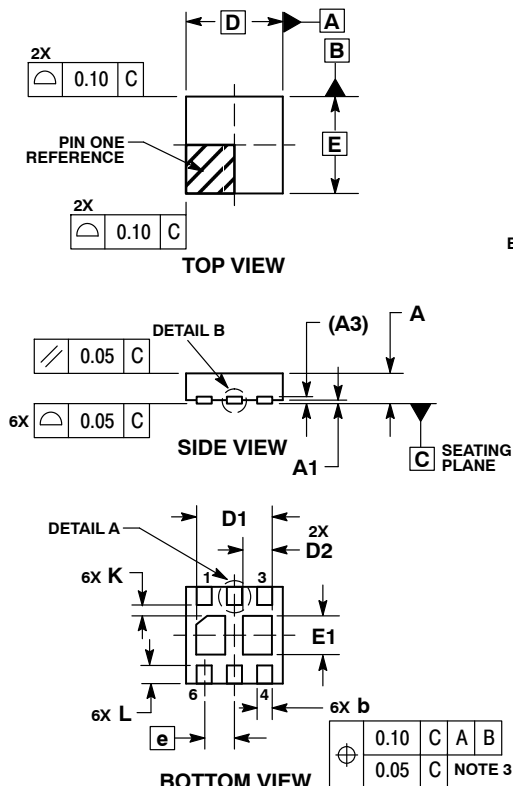
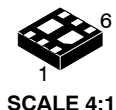

- NOTES:
1. DIMENSIONING AND TOLERANCING PER ASME Y14.5M, 1994.
 2. CONTROLLING DIMENSION: MILLIMETERS.
 3. DIMENSION b APPLIES TO PLATED TERMINAL AND IS MEASURED BETWEEN 0.15 AND 0.30 mm FROM TERMINAL.
 4. COPLANARITY APPLIES TO THE EXPOSED PAD AS WELL AS THE TERMINALS.

MILLIMETERS		
DIM	MIN	MAX
A	0.45	0.55
A1	0.00	0.05
A3	0.13	REF
b	0.20	0.30
D	1.60	BSC
E	1.60	BSC
e	0.50	BSC
D1	1.14	1.34
D2	0.38	0.58
E1	0.54	0.74
K	0.20	---
L	0.15	0.35
L1	---	0.10

GENERIC MARKING DIAGRAM*

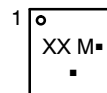

- XX = Specific Device Code
- M = Date Code
- = Pb-Free Package

(Note: Microdot may be in either location)

*This information is generic. Please refer to device data sheet for actual part marking.

Pb-Free indicator, "G" or microdot "▪", may or may not be present.

SOLDERMASK DEFINED MOUNTING FOOTPRINT*

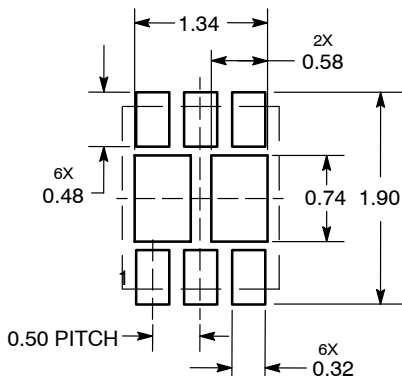

DIMENSIONS: MILLIMETERS

*For additional information on our Pb-Free strategy and soldering details, please download the ON Semiconductor Soldering and Mounting Techniques Reference Manual, SOLDERRM/D.

DOCUMENT NUMBER:	98AON32372E	Electronic versions are uncontrolled except when accessed directly from the Document Repository. Printed versions are uncontrolled except when stamped "CONTROLLED COPY" in red.
DESCRIPTION:	6 PIN UDFN, 1.6X1.6, 0.5P	PAGE 1 OF 1

ON Semiconductor and ON are trademarks of Semiconductor Components Industries, LLC dba ON Semiconductor or its subsidiaries in the United States and/or other countries. ON Semiconductor reserves the right to make changes without further notice to any products herein. ON Semiconductor makes no warranty, representation or guarantee regarding the suitability of its products for any particular purpose, nor does ON Semiconductor assume any liability arising out of the application or use of any product or circuit, and specifically disclaims any and all liability, including without limitation special, consequential or incidental damages. ON Semiconductor does not convey any license under its patent rights nor the rights of others.

onsemi, **Onsemi**, and other names, marks, and brands are registered and/or common law trademarks of Semiconductor Components Industries, LLC dba "**onsemi**" or its affiliates and/or subsidiaries in the United States and/or other countries. **onsemi** owns the rights to a number of patents, trademarks, copyrights, trade secrets, and other intellectual property. A listing of **onsemi**'s product/patent coverage may be accessed at www.onsemi.com/site/pdf/Patent-Marking.pdf. **onsemi** reserves the right to make changes at any time to any products or information herein, without notice. The information herein is provided "as-is" and **onsemi** makes no warranty, representation or guarantee regarding the accuracy of the information, product features, availability, functionality, or suitability of its products for any particular purpose, nor does **onsemi** assume any liability arising out of the application or use of any product or circuit, and specifically disclaims any and all liability, including without limitation special, consequential or incidental damages. Buyer is responsible for its products and applications using **onsemi** products, including compliance with all laws, regulations and safety requirements or standards, regardless of any support or applications information provided by **onsemi**. "Typical" parameters which may be provided in **onsemi** data sheets and/or specifications can and do vary in different applications and actual performance may vary over time. All operating parameters, including "Typicals" must be validated for each customer application by customer's technical experts. **onsemi** does not convey any license under any of its intellectual property rights nor the rights of others. **onsemi** products are not designed, intended, or authorized for use as a critical component in life support systems or any FDA Class 3 medical devices or medical devices with a same or similar classification in a foreign jurisdiction or any devices intended for implantation in the human body. Should Buyer purchase or use **onsemi** products for any such unintended or unauthorized application, Buyer shall indemnify and hold **onsemi** and its officers, employees, subsidiaries, affiliates, and distributors harmless against all claims, costs, damages, and expenses, and reasonable attorney fees arising out of, directly or indirectly, any claim of personal injury or death associated with such unintended or unauthorized use, even if such claim alleges that **onsemi** was negligent regarding the design or manufacture of the part. **onsemi** is an Equal Opportunity/Affirmative Action Employer. This literature is subject to all applicable copyright laws and is not for resale in any manner.

PUBLICATION ORDERING INFORMATION

LITERATURE FULFILLMENT:

Email Requests to: orderlit@onsemi.com

onsemi Website: www.onsemi.com

TECHNICAL SUPPORT

North American Technical Support:

Voice Mail: 1 800-282-9855 Toll Free USA/Canada

Phone: 011 421 33 790 2910

Europe, Middle East and Africa Technical Support:

Phone: 00421 33 790 2910

For additional information, please contact your local Sales Representative