

NTNS3164NZ

MOSFET – Single, N-Channel, Small Signal, SOT-883 (XDFN3), 1.0 x 0.6 x 0.4 mm

20 V, 361 Ma

Features

- Single N–Channel MOSFET
- Ultra Low Profile SOT–883 (XDFN3) 1.0 x 0.6 x 0.4 mm for Extremely Thin Environments Such as Portable Electronics
- Low $R_{DS(on)}$ Solution in the Ultra Small 1.0 x 0.6 mm Package
- 1.5 V Gate Drive
- These Devices are Pb–Free, Halogen Free/BFR Free and are RoHS Compliant

Applications

- High Side Switch
- High Speed Interfacing
- Level Shift and Translate
- Optimized for Power Management in Ultra Portable Solutions

MAXIMUM RATINGS ($T_J = 25^\circ\text{C}$ unless otherwise stated)

Parameter			Symbol	Value	Unit
Drain–to–Source Voltage			V_{DSS}	20	V
Gate–to–Source Voltage			V_{GS}	± 8	V
Continuous Drain Current (Note 1)	Steady State	$T_A = 25^\circ\text{C}$	I_D	361	mA
		$T_A = 85^\circ\text{C}$		260	
	$t \leq 5\text{ s}$	$T_A = 25^\circ\text{C}$		427	
Power Dissipation (Note 1)	Steady State	$T_A = 25^\circ\text{C}$	P_D	155	mW
				$t \leq 5\text{ s}$	
Pulsed Drain Current	$t_p = 10\ \mu\text{s}$		I_{DM}	1082	mA
Operating Junction and Storage Temperature			T_J, T_{STG}	–55 to 150	$^\circ\text{C}$
Source Current (Body Diode) (Note 2)			I_S	129	mA
Lead Temperature for Soldering Purposes (1/8" from case for 10 s)			T_L	260	$^\circ\text{C}$

Stresses exceeding Maximum Ratings may damage the device. Maximum Ratings are stress ratings only. Functional operation above the Recommended Operating Conditions is not implied. Extended exposure to stresses above the Recommended Operating Conditions may affect device reliability.

1. Surface–mounted on FR4 board using the minimum recommended pad size, or 2 mm^2 , 1 oz Cu.
2. Pulse Test: pulse width $\leq 300\ \mu\text{s}$, duty cycle $\leq 2\%$



ON Semiconductor®

<http://onsemi.com>

$V_{(BR)DSS}$	$R_{DS(on)}$ MAX	I_D Max
20 V	0.7 Ω @ 4.5 V	361 mA
	1.0 Ω @ 2.5 V	
	2.0 Ω @ 1.8 V	
	4.0 Ω @ 1.5 V	

N-CHANNEL MOSFET

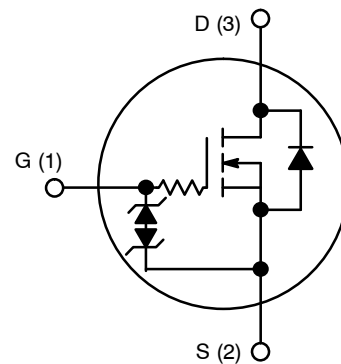

MARKING DIAGRAM

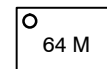

**SOT–883 (XDFN3)
CASE 506CB**

64 = Specific Device Code
M = Date Code

ORDERING INFORMATION

Device	Package	Shipping†
NTNS3164NZT5G	SOT–883 (Pb–Free)	8000 / Tape & Reel

†For information on tape and reel specifications, including part orientation and tape sizes, please refer to our Tape and Reel Packaging Specification Brochure, BRD8011/D.

NTNS3164NZ

THERMAL RESISTANCE RATINGS

Parameter	Symbol	Max	Unit
Junction-to-Ambient – Steady State (Note 3)	$R_{\theta JA}$	806	°C/W
Junction-to-Ambient – $t \leq 5$ s (Note 3)	$R_{\theta JA}$	575	

3. Surface-mounted on FR4 board using the minimum recommended pad size, or 2 mm², 1 oz Cu.

ELECTRICAL CHARACTERISTICS ($T_J = 25^\circ\text{C}$ unless otherwise stated)

Parameter	Symbol	Test Condition	Min	Typ	Max	Unit
-----------	--------	----------------	-----	-----	-----	------

OFF CHARACTERISTICS

Drain-to-Source Breakdown Voltage	$V_{(BR)DSS}$	$V_{GS} = 0$ V, $I_D = 250$ μ A	20			V
Drain-to-Source Breakdown Voltage Temperature Coefficient	$V_{(BR)DSS}/T_J$	$I_D = 250$ μ A, ref to 25°C		23		mV/°C
Zero Gate Voltage Drain Current	I_{DSS}	$V_{GS} = 0$ V, $V_{DS} = 20$ V, $T_J = 25^\circ\text{C}$			1	μ A
Gate-to-Source Leakage Current	I_{GSS}	$V_{DS} = 0$ V, $V_{GS} = \pm 5$ V			± 10	μ A

ON CHARACTERISTICS (Note 4)

Gate Threshold Voltage	$V_{GS(TH)}$	$V_{GS} = V_{DS}$, $I_D = 250$ μ A	0.4		1.0	V
Negative Threshold Temperature Coefficient	$V_{GS(TH)}/T_J$			1.8		mV/°C
Drain-to-Source On Resistance	$R_{DS(on)}$	$V_{GS} = 4.5$ V, $I_D = 200$ mA		0.5	0.7	Ω
		$V_{GS} = 2.5$ V, $I_D = 100$ mA		0.7	1.0	
		$V_{GS} = 1.8$ V, $I_D = 50$ mA		1.0	2.0	
		$V_{GS} = 1.5$ V, $I_D = 10$ mA		1.2	4.0	
Forward Transconductance	g_{FS}	$V_{DS} = 5$ V, $I_D = 200$ mA		1.26		S
Source-Drain Diode Voltage	V_{SD}	$V_{GS} = 0$ V, $I_S = 100$ mA		0.75	1.2	V

CHARGES & CAPACITANCES

Input Capacitance	C_{ISS}	$V_{GS} = 0$ V, freq = 1 MHz, $V_{DS} = 10$ V		24		pF
Output Capacitance	C_{OSS}			5.0		
Reverse Transfer Capacitance	C_{RSS}			3.4		
Total Gate Charge	$Q_{G(TOT)}$	$V_{GS} = 4.5$ V, $V_{DS} = 10$ V; $I_D = 200$ mA		0.8		nC
Threshold Gate Charge	$Q_{G(TH)}$			0.1		
Gate-to-Source Charge	Q_{GS}			0.2		
Gate-to-Drain Charge	Q_{GD}			0.1		

SWITCHING CHARACTERISTICS, $V_{GS} = 4.5$ V (Note 4)

Turn-On Delay Time	$t_{d(ON)}$	$V_{GS} = 4.5$ V, $V_{DD} = 10$ V, $I_D = 200$ mA, $R_G = 2$ Ω		10		ns
Rise Time	t_r			11		
Turn-Off Delay Time	$t_{d(OFF)}$			67		
Fall Time	t_f			31		

4. Switching characteristics are independent of operating junction temperatures

NTNS3164NZ

TYPICAL CHARACTERISTICS

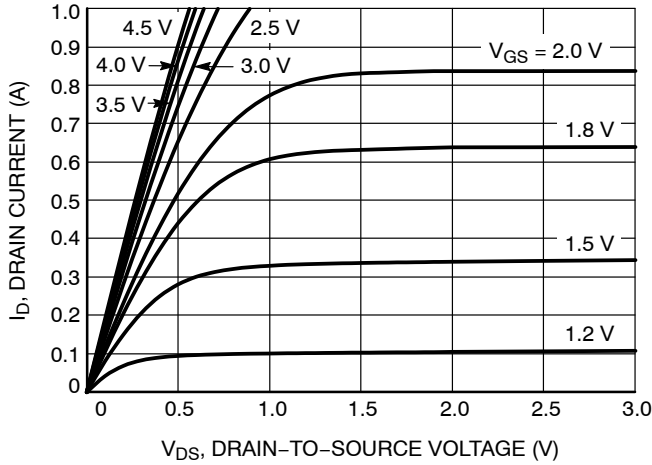

Figure 1. On-Region Characteristics

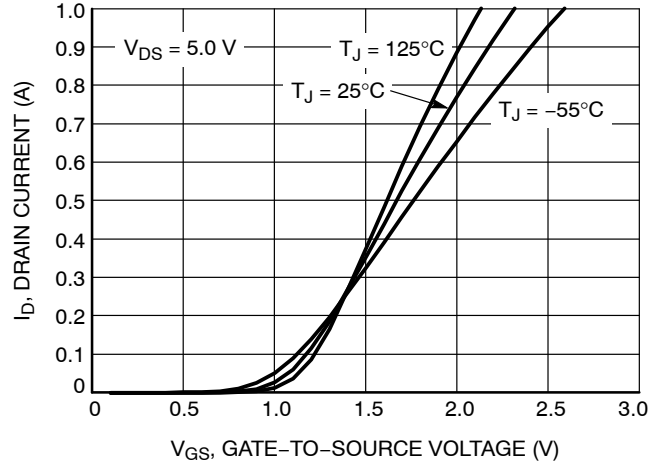

Figure 2. Transfer Characteristics

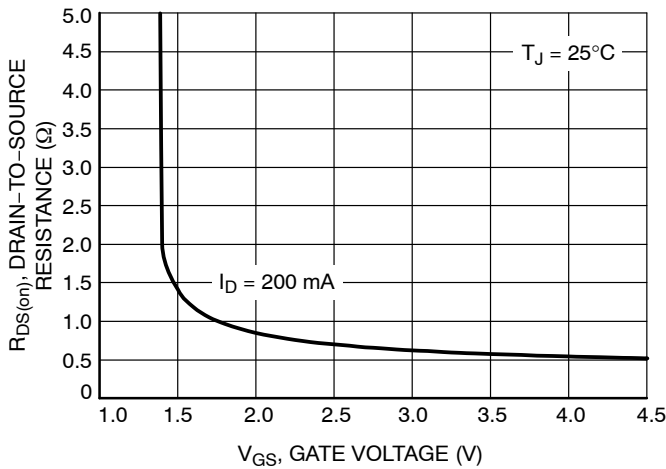

Figure 3. On-Resistance vs. Gate-to-Source Voltage

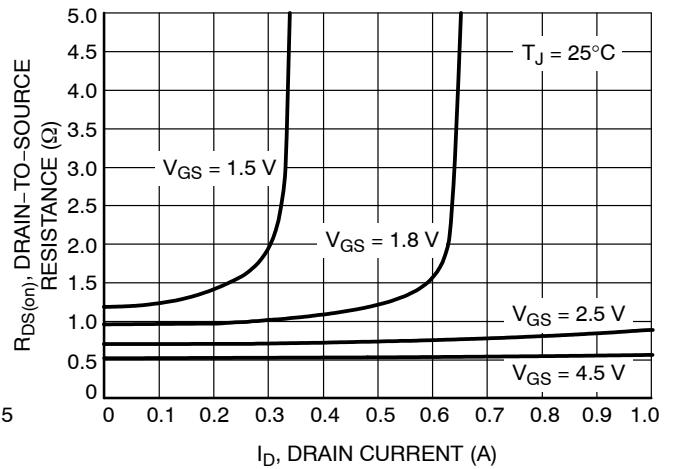

Figure 4. On-Resistance vs. Drain Current and Gate Voltage

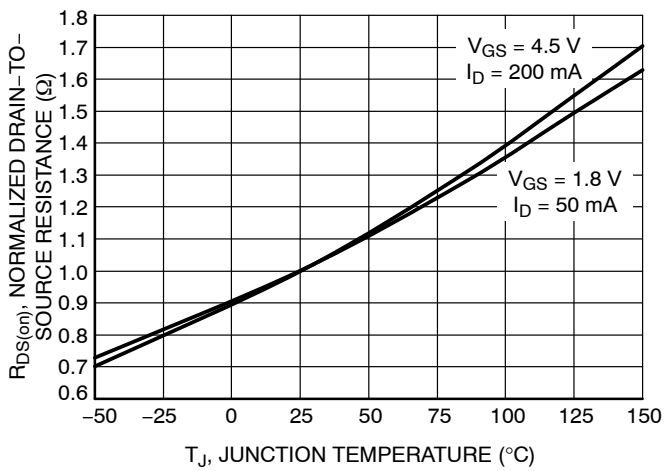

Figure 5. On-Resistance Variation with Temperature

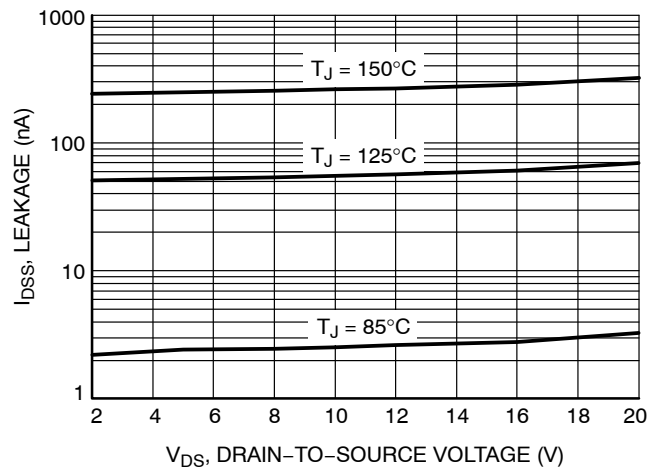

Figure 6. Drain-to-Source Leakage Current vs. Voltage

NTNS3164NZ

TYPICAL CHARACTERISTICS

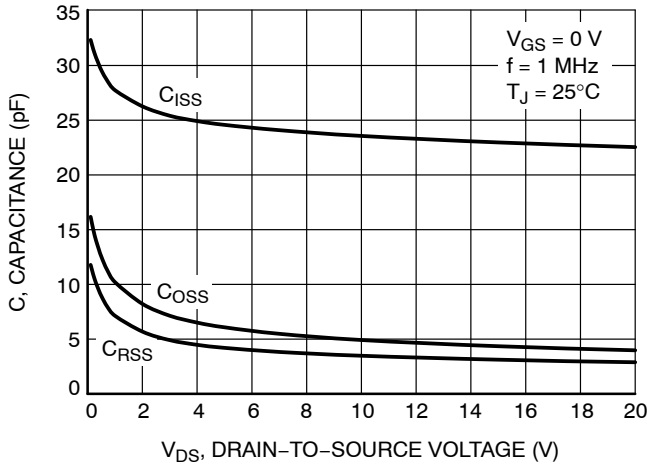

Figure 7. Capacitance Variation

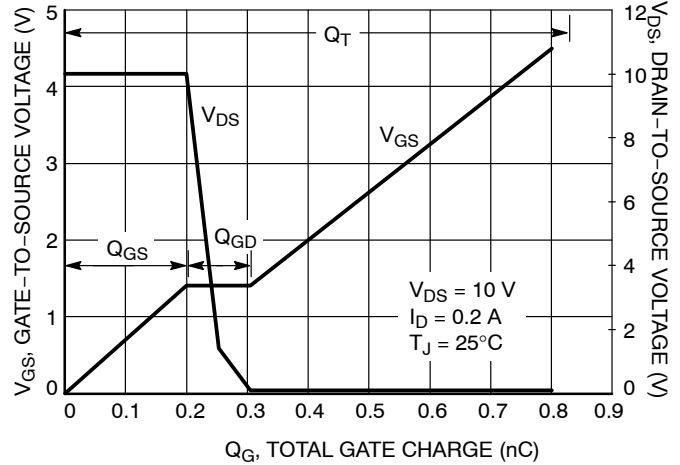

Figure 8. Gate-to-Source and Drain-to-Source Voltage vs. Total Charge

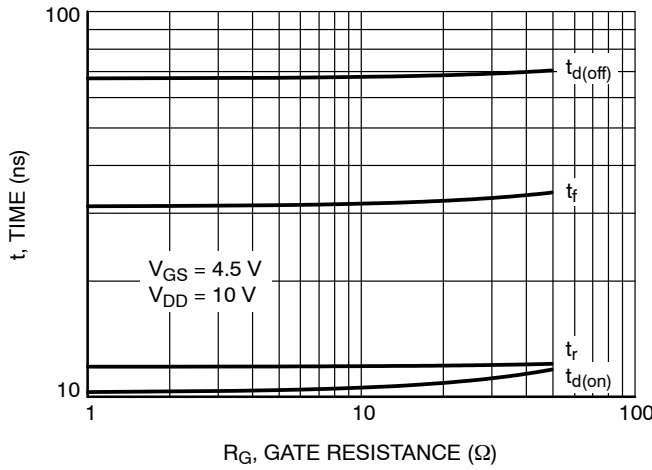

Figure 9. Resistive Switching Time Variation vs. Gate Resistance

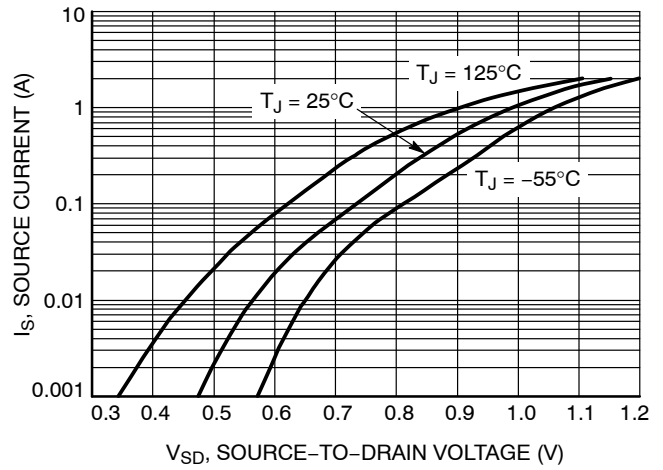

Figure 10. Diode Forward Voltage vs. Current

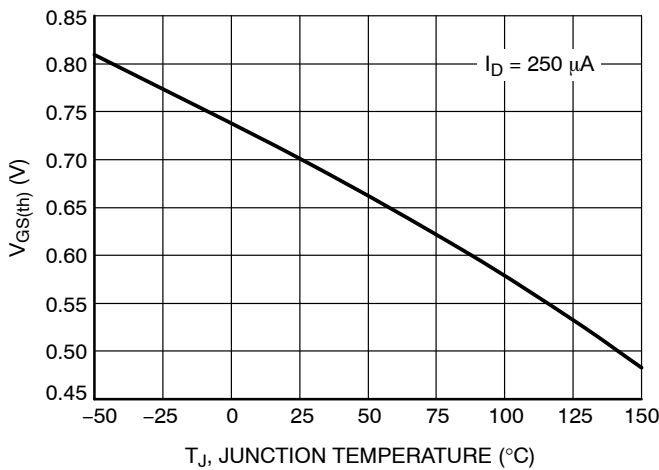

Figure 11. Threshold Voltage

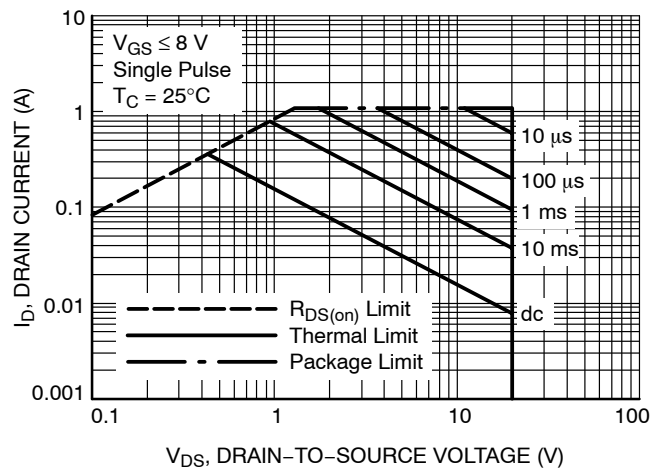

Figure 12. Maximum Rated Forward Biased Safe Operating Area

NTNS3164NZ

TYPICAL CHARACTERISTICS

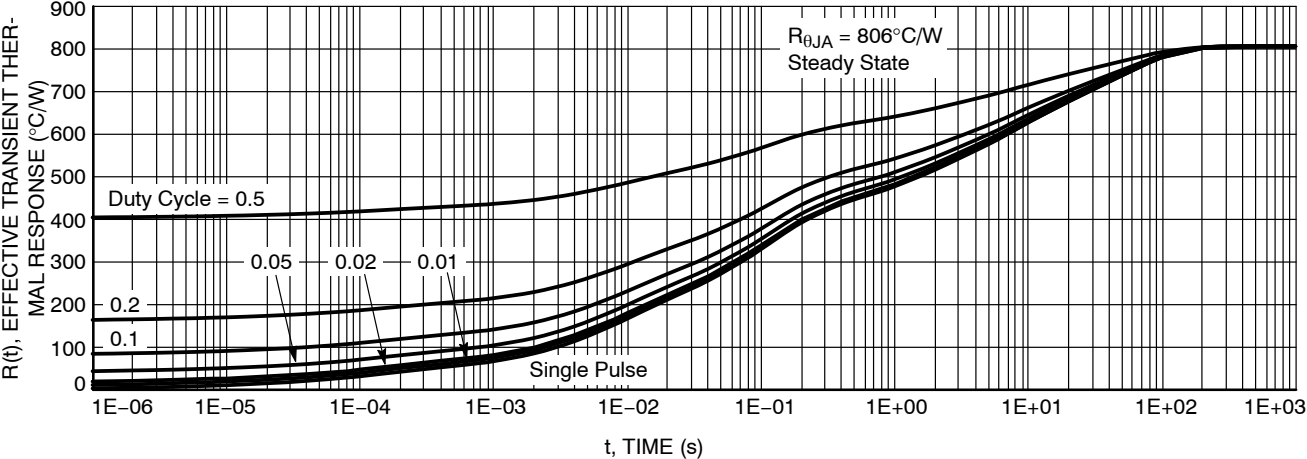

Figure 13. FET Thermal Response

MECHANICAL CASE OUTLINE

PACKAGE DIMENSIONS

ON Semiconductor®



SOT-883 (XDFN3), 1.0x0.6, 0.35P
CASE 506CB
ISSUE A

DATE 30 MAR 2012



SCALE 8:1

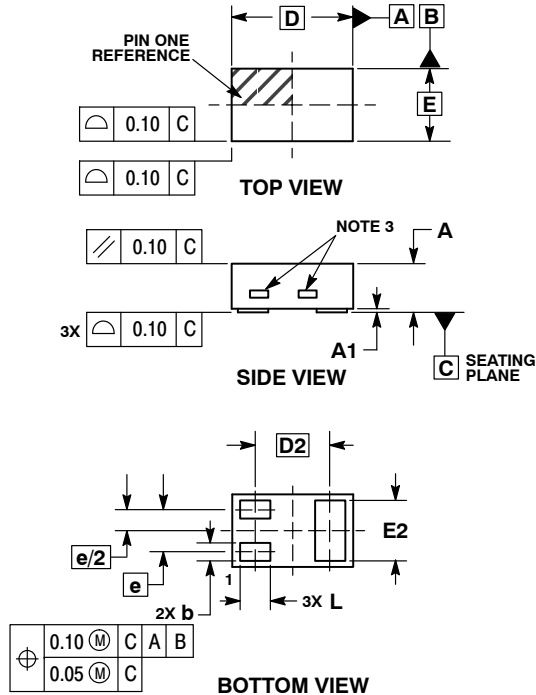

NOTES:

1. DIMENSIONING AND TOLERANCING PER ASME Y14.5M, 1994.
2. CONTROLLING DIMENSION: MILLIMETERS.
3. EXPOSED COPPER ALLOWED AS SHOWN.

MILLIMETERS		
DIM	MIN	MAX
A	0.340	0.440
A1	0.000	0.030
b	0.075	0.200
D	0.950	1.075
D2	0.620 BSC	
e	0.350 BSC	
E	0.550	0.675
E2	0.425	0.550
L	0.170	0.300

GENERIC MARKING DIAGRAM*

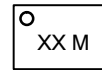

XX = Specific Device Code
M = Date Code

*This information is generic. Please refer to device data sheet for actual part marking. Pb-Free indicator, "G", may or not be present.

RECOMMENDED SOLDER FOOTPRINT*

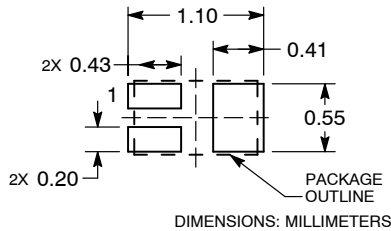

*For additional information on our Pb-Free strategy and soldering details, please download the ON Semiconductor Soldering and Mounting Techniques Reference Manual, SOLDERRM/D.

DOCUMENT NUMBER:	98AON65407E	Electronic versions are uncontrolled except when accessed directly from the Document Repository. Printed versions are uncontrolled except when stamped "CONTROLLED COPY" in red.
DESCRIPTION:	SOT-883 (XDFN3), 1.0X0.6, 0.35P	PAGE 1 OF 1

ON Semiconductor and are trademarks of Semiconductor Components Industries, LLC dba ON Semiconductor or its subsidiaries in the United States and/or other countries. ON Semiconductor reserves the right to make changes without further notice to any products herein. ON Semiconductor makes no warranty, representation or guarantee regarding the suitability of its products for any particular purpose, nor does ON Semiconductor assume any liability arising out of the application or use of any product or circuit, and specifically disclaims any and all liability, including without limitation special, consequential or incidental damages. ON Semiconductor does not convey any license under its patent rights nor the rights of others.

onsemi, **Onsemi**, and other names, marks, and brands are registered and/or common law trademarks of Semiconductor Components Industries, LLC dba "**onsemi**" or its affiliates and/or subsidiaries in the United States and/or other countries. **onsemi** owns the rights to a number of patents, trademarks, copyrights, trade secrets, and other intellectual property. A listing of **onsemi**'s product/patent coverage may be accessed at www.onsemi.com/site/pdf/Patent-Marking.pdf. **onsemi** reserves the right to make changes at any time to any products or information herein, without notice. The information herein is provided "as-is" and **onsemi** makes no warranty, representation or guarantee regarding the accuracy of the information, product features, availability, functionality, or suitability of its products for any particular purpose, nor does **onsemi** assume any liability arising out of the application or use of any product or circuit, and specifically disclaims any and all liability, including without limitation special, consequential or incidental damages. Buyer is responsible for its products and applications using **onsemi** products, including compliance with all laws, regulations and safety requirements or standards, regardless of any support or applications information provided by **onsemi**. "Typical" parameters which may be provided in **onsemi** data sheets and/or specifications can and do vary in different applications and actual performance may vary over time. All operating parameters, including "Typicals" must be validated for each customer application by customer's technical experts. **onsemi** does not convey any license under any of its intellectual property rights nor the rights of others. **onsemi** products are not designed, intended, or authorized for use as a critical component in life support systems or any FDA Class 3 medical devices or medical devices with a same or similar classification in a foreign jurisdiction or any devices intended for implantation in the human body. Should Buyer purchase or use **onsemi** products for any such unintended or unauthorized application, Buyer shall indemnify and hold **onsemi** and its officers, employees, subsidiaries, affiliates, and distributors harmless against all claims, costs, damages, and expenses, and reasonable attorney fees arising out of, directly or indirectly, any claim of personal injury or death associated with such unintended or unauthorized use, even if such claim alleges that **onsemi** was negligent regarding the design or manufacture of the part. **onsemi** is an Equal Opportunity/Affirmative Action Employer. This literature is subject to all applicable copyright laws and is not for resale in any manner.

PUBLICATION ORDERING INFORMATION

LITERATURE FULFILLMENT:

Email Requests to: orderlit@onsemi.com

onsemi Website: www.onsemi.com

TECHNICAL SUPPORT

North American Technical Support:

Voice Mail: 1 800-282-9855 Toll Free USA/Canada

Phone: 011 421 33 790 2910

Europe, Middle East and Africa Technical Support:

Phone: 00421 33 790 2910

For additional information, please contact your local Sales Representative