

NUP46V8P5

ESD Protection Diode Array

Quad, Low Capacitance

This integrated surge protection device is designed for applications requiring transient overvoltage protection. It is intended to be used in sensitive equipment such as wireless headsets, PDAs, digital cameras, computers, printers, communication systems, and other applications. The integrated design provides very effective and reliable protection for four separate lines using only one package. This device is ideal for situations where board space is at a premium.

Features

- ESD Protection: IEC61000-4-2: Level 4
- Four Separate Unidirectional Configurations for Protection
- Low Leakage Current < 1 μ A @ 3 V
- Small SOT-953 SMT Package
- Low Capacitance
- This is a Pb-Free Device

Benefits

- Provides Protection for ESD Industry Standards: IEC 61000, HBM
- Protects Four Lines Against Transient Voltage Conditions
- Minimize Power Consumption of the System
- Minimize PCB Board Space

Typical Applications

- Cellular and Portable Electronics
- Serial and Parallel Ports
- Microprocessor Based Equipment
- Notebooks, Desktops, Servers



ON Semiconductor®

www.onsemi.com

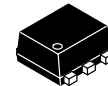
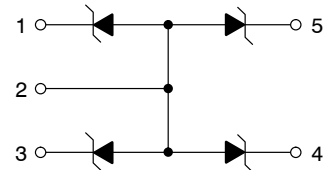

SCALE 4:1

SOT-953
CASE 526AE

MARKING DIAGRAM

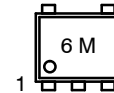

6 = Specific Device Code
M = Date Code

ORDERING INFORMATION

Device	Package	Shipping†
NUP46V8P5T5G	SOT-953 (Pb-Free)	8000 / Tape & Reel

†For information on tape and reel specifications, including part orientation and tape sizes, please refer to our Tape and Reel Packaging Specification Brochure, BRD8011/D.

NUP46V8P5

ELECTRICAL CHARACTERISTICS

($T_A = 25^\circ\text{C}$ unless otherwise noted)

Symbol	Parameter
I_{PP}	Maximum Reverse Peak Pulse Current
V_C	Clamping Voltage @ I_{PP}
V_{RWM}	Working Peak Reverse Voltage
I_R	Maximum Reverse Leakage Current @ V_{RWM}
V_{BR}	Breakdown Voltage @ I_T
I_T	Test Current
Θ_{VBR}	Maximum Temperature Coefficient of V_{BR}
I_F	Forward Current
V_F	Forward Voltage @ I_F
Z_{ZT}	Maximum Zener Impedance @ I_{ZT}
I_{ZK}	Reverse Current
Z_{ZK}	Maximum Zener Impedance @ I_{ZK}

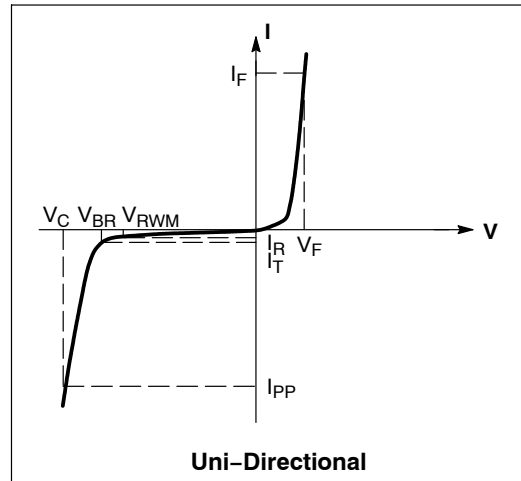

MAXIMUM RATINGS ($T_A = 25^\circ\text{C}$ unless otherwise noted)

Characteristic	Symbol	Value	Unit
Peak Power Dissipation (8 X 20 μs @ $T_A = 25^\circ\text{C}$) (Note 1)	P_{PK}	10	W
Thermal Resistance Junction-to-Ambient Above 25°C , Derate	$R_{\theta JA}$	560 4.5	$^\circ\text{C}/\text{W}$ $\text{mW}/^\circ\text{C}$
Maximum Junction Temperature	T_{Jmax}	150	$^\circ\text{C}$
Operating Junction and Storage Temperature Range	T_J T_{stg}	-55 to +150	$^\circ\text{C}$
Lead Solder Temperature (10 seconds duration)	T_L	260	$^\circ\text{C}$
Human Body Model (HBM) Machine Model (MM)	ESD	8000 400	V

Stresses exceeding those listed in the Maximum Ratings table may damage the device. If any of these limits are exceeded, device functionality should not be assumed, damage may occur and reliability may be affected.

ELECTRICAL CHARACTERISTICS ($T_A = 25^\circ\text{C}$)

Device	Device Marking	Breakdown Voltage V_{BR} @ 1 mA (Volts)			Leakage Current I_{RM} @ V_{RM}		Typ Capacitance @ 0 V Bias (pF) (Note 2)		Typ Capacitance @ 3 V Bias (pF) (Note 2)	
		Min	Nom	Max	V_{RWM}	I_{RWM} (μA)	Typ	Max	Typ	Max
NUP46V8P5	6	6.47	6.8	7.14	4.3	1.0	12	15	6.7	9.5

1. Non-repetitive current per Figure 1.
2. Capacitance of one diode at $f = 1$ MHz, $V_R = 0$ V, $T_A = 25^\circ\text{C}$.

TYPICAL ELECTRICAL CHARACTERISTICS

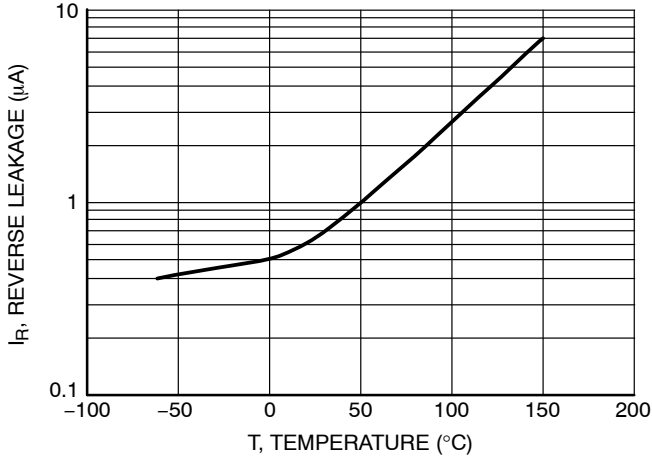

Figure 1. Reverse Leakage versus Temperature

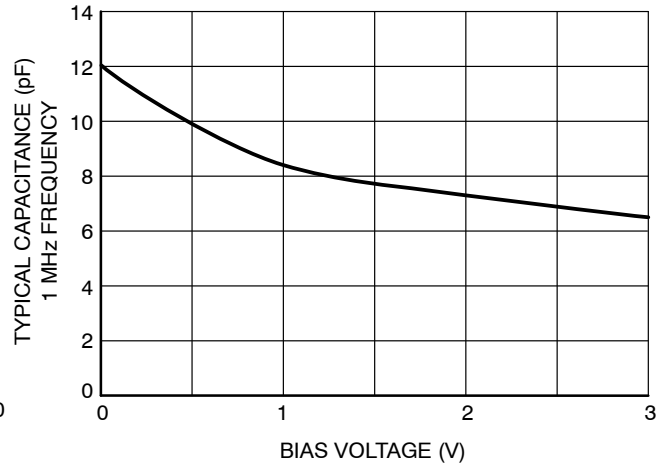

Figure 2. Capacitance

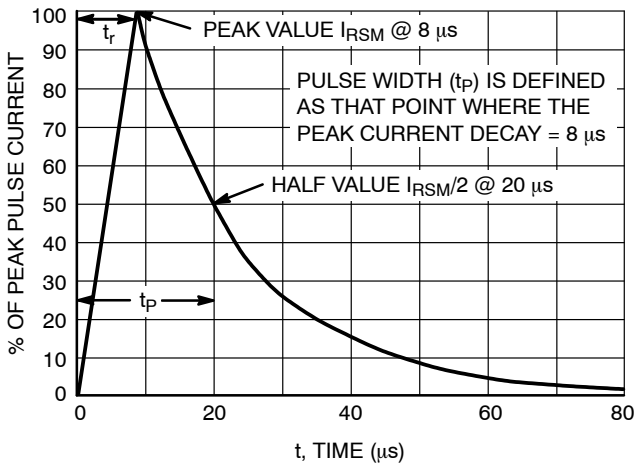

Figure 3. 8 × 20 μs Pulse Waveform

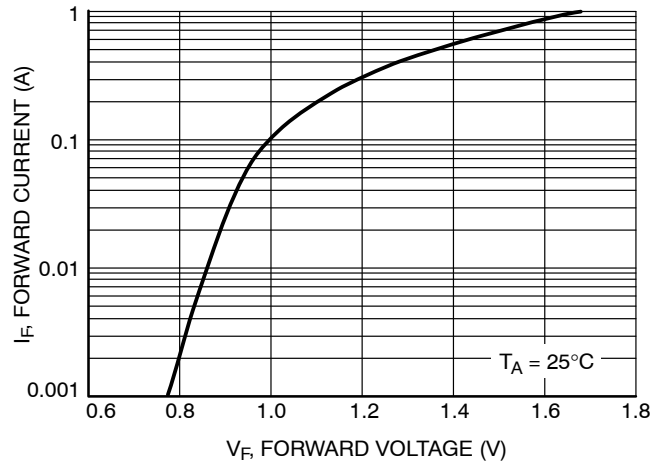

Figure 4. Forward Voltage

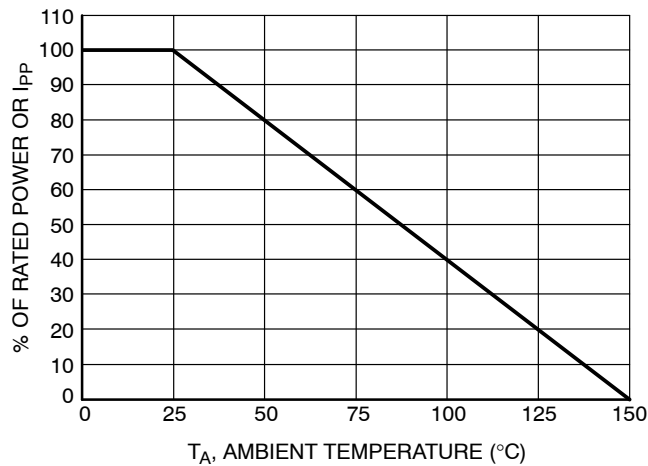

Figure 5. Power Derating Curve

MECHANICAL CASE OUTLINE

PACKAGE DIMENSIONS

ON Semiconductor®



SCALE 4:1

SOT-953
CASE 527AE
ISSUE E

DATE 02 AUG 2011

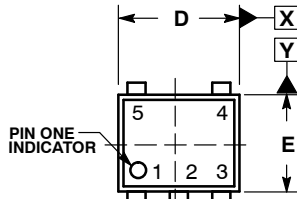

TOP VIEW

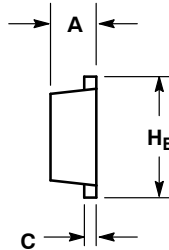

SIDE VIEW

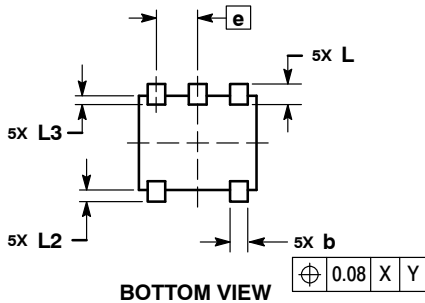

BOTTOM VIEW

NOTES:

1. DIMENSIONING AND TOLERANCING PER ASME Y14.5M, 1994.
2. CONTROLLING DIMENSION: MILLIMETERS
3. MAXIMUM LEAD THICKNESS INCLUDES LEAD FINISH. MINIMUM LEAD THICKNESS IS THE MINIMUM THICKNESS OF THE BASE MATERIAL.
4. DIMENSIONS D AND E DO NOT INCLUDE MOLD FLASH, PROTRUSIONS, OR GATE BURRS.

DIM	MILLIMETERS		
	MIN	NOM	MAX
A	0.34	0.37	0.40
b	0.10	0.15	0.20
C	0.07	0.12	0.17
D	0.95	1.00	1.05
E	0.75	0.80	0.85
e	0.35 BSC		
H _E	0.95	1.00	1.05
L	0.175 REF		
L2	0.05	0.10	0.15
L3	---	---	0.15

GENERIC MARKING DIAGRAM*

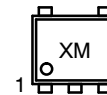

X = Specific Device Code
M = Month Code

*This information is generic. Please refer to device data sheet for actual part marking.
Pb-Free indicator, "G" or microdot "▪", may or may not be present.

SOLDERING FOOTPRINT*

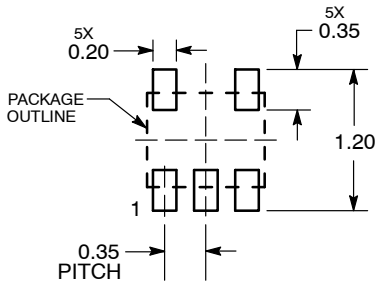

DIMENSIONS: MILLIMETERS

*For additional information on our Pb-Free strategy and soldering details, please download the ON Semiconductor Soldering and Mounting Techniques Reference Manual, SOLDERRM/D.

DOCUMENT NUMBER:	98AON26457D	Electronic versions are uncontrolled except when accessed directly from the Document Repository. Printed versions are uncontrolled except when stamped "CONTROLLED COPY" in red.
DESCRIPTION:	SOT-953	PAGE 1 OF 1

ON Semiconductor and are trademarks of Semiconductor Components Industries, LLC dba ON Semiconductor or its subsidiaries in the United States and/or other countries. ON Semiconductor reserves the right to make changes without further notice to any products herein. ON Semiconductor makes no warranty, representation or guarantee regarding the suitability of its products for any particular purpose, nor does ON Semiconductor assume any liability arising out of the application or use of any product or circuit, and specifically disclaims any and all liability, including without limitation special, consequential or incidental damages. ON Semiconductor does not convey any license under its patent rights nor the rights of others.

onsemi, **Onsemi**, and other names, marks, and brands are registered and/or common law trademarks of Semiconductor Components Industries, LLC dba "**onsemi**" or its affiliates and/or subsidiaries in the United States and/or other countries. **onsemi** owns the rights to a number of patents, trademarks, copyrights, trade secrets, and other intellectual property. A listing of **onsemi**'s product/patent coverage may be accessed at www.onsemi.com/site/pdf/Patent-Marking.pdf. **onsemi** reserves the right to make changes at any time to any products or information herein, without notice. The information herein is provided "as-is" and **onsemi** makes no warranty, representation or guarantee regarding the accuracy of the information, product features, availability, functionality, or suitability of its products for any particular purpose, nor does **onsemi** assume any liability arising out of the application or use of any product or circuit, and specifically disclaims any and all liability, including without limitation special, consequential or incidental damages. Buyer is responsible for its products and applications using **onsemi** products, including compliance with all laws, regulations and safety requirements or standards, regardless of any support or applications information provided by **onsemi**. "Typical" parameters which may be provided in **onsemi** data sheets and/or specifications can and do vary in different applications and actual performance may vary over time. All operating parameters, including "Typicals" must be validated for each customer application by customer's technical experts. **onsemi** does not convey any license under any of its intellectual property rights nor the rights of others. **onsemi** products are not designed, intended, or authorized for use as a critical component in life support systems or any FDA Class 3 medical devices or medical devices with a same or similar classification in a foreign jurisdiction or any devices intended for implantation in the human body. Should Buyer purchase or use **onsemi** products for any such unintended or unauthorized application, Buyer shall indemnify and hold **onsemi** and its officers, employees, subsidiaries, affiliates, and distributors harmless against all claims, costs, damages, and expenses, and reasonable attorney fees arising out of, directly or indirectly, any claim of personal injury or death associated with such unintended or unauthorized use, even if such claim alleges that **onsemi** was negligent regarding the design or manufacture of the part. **onsemi** is an Equal Opportunity/Affirmative Action Employer. This literature is subject to all applicable copyright laws and is not for resale in any manner.

PUBLICATION ORDERING INFORMATION

LITERATURE FULFILLMENT:

Email Requests to: orderlit@onsemi.com

onsemi Website: www.onsemi.com

TECHNICAL SUPPORT

North American Technical Support:

Voice Mail: 1 800-282-9855 Toll Free USA/Canada

Phone: 011 421 33 790 2910

Europe, Middle East and Africa Technical Support:

Phone: 00421 33 790 2910

For additional information, please contact your local Sales Representative