

NCP102

Low Dropout Linear Regulator Controller

The NCP102 is a low dropout linear regulator controller for applications requiring high-current and ultra low dropout voltages. The use of an external N-Channel MOSFET allows the user to adapt the device to a multitude of applications depending on system requirements for current and dropout voltage.

An extremely accurate 0.8 V ($\pm 2\%$) reference allows the implementation of sub 1 V voltage supplies. The reference is guaranteed over the complete supply and temperature ranges.

Other features of the NCP102 are a dedicated enable input, internally compensated error amplifier and an adjustable soft-start. A minimum drive capability of ± 5 mA provides fast transient response. The drive current is internally limited to protect the controller in case of an external MOSFET failure. The NCP102 is packaged in a space saving TSOP-6.

Features

- 4.5 V to 13.5 V Supply Voltage Range
- 0.8 V ($\pm 2\%$) Voltage Reference (Temperature and Process)
- Programmable Regulator Output Voltage Down to 0.8 V
- Drive Current Capability of $> \pm 5$ mA
- MLCC and POSCAP Compatible
- Programmable Soft-Start
- Enable Active High
- Space Saving TSOP-6 Package
- RoHS Compliant Pb-Free Package

Applications

- Desktop and Laptops
- Computer Peripherals such as Graphics Cards
- Sub 1 V Power Supplies

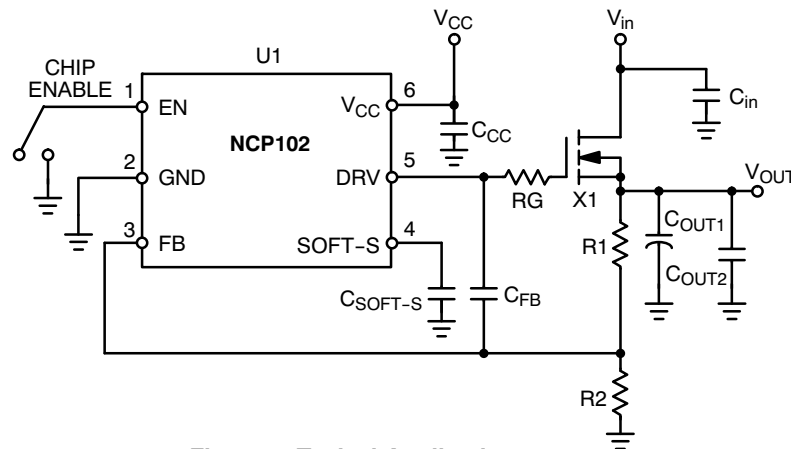

Figure 1. Typical Application



ON Semiconductor®

<http://onsemi.com>



TSOP-6
(SOT23-6)
SN SUFFIX
CASE 318G

MARKING DIAGRAM

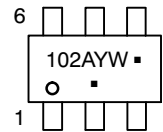

- 102 = Device Code
- A = Assembly Location
- Y = Year
- W = Work Week
- = Pb-Free Package

(Note: Microdot may be in either location)

PIN CONNECTIONS

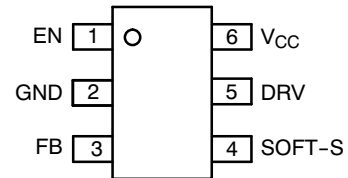

(Top View)

ORDERING INFORMATION

Device	Package	Shipping†
NCP102SNT1G	TSOP-6 (Pb-Free)	3000/Tape & Reel

†For information on tape and reel specifications, including part orientation and tape sizes, please refer to our Tape and Reel Packaging Specifications Brochure, BRD8011/D.

NCP102

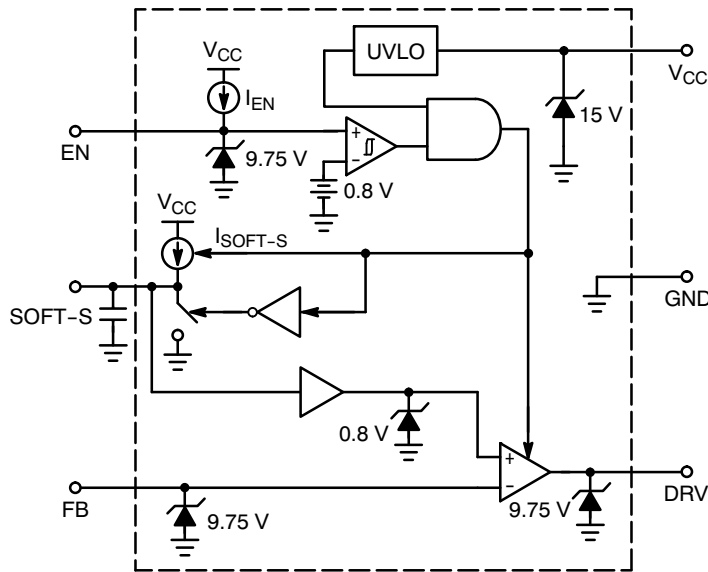

Figure 2. Representative Block Diagram

PIN FUNCTION DESCRIPTION

Pin	Symbol Name	Description
1	EN	Enable Input (Active High). Pull the EN pin below 0.8 V to disable the regulator and enter the standby mode operation.
2	GND	Ground
3	FB	Inverting input of the error amplifier. The output voltage is sampled by means of a resistor divider and applied to this pin for regulation.
4	SOFT-S	Programmable soft-start. An internal current source charges the capacitor connected to this pin. The soft-start period ends once the voltage of the soft-start capacitor reaches 0.8 V.
5	DRV	Gate drive for external N-Channel MOSFET. It is also the buffered output of the error amplifier.
6	V _{CC}	Power supply voltage input. Operating voltage range is from 4.5 to 13.5 V. A decoupling capacitor to GND should be used. A minimum of 0.1 μ F is recommended.

NCP102

MAXIMUM RATINGS (T_A = 25°C, unless otherwise noted)

Rating	Symbol	Value	Unit
Main Supply Input Voltage	V _{CC}	-0.3 to 15	V
Main Supply Input Current	I _{CC}	100	mA
Enable Voltage	V _{EN}	-0.3 to 9.75	V
Enable Current	I _{EN}	100	mA
Soft-Start Voltage	V _{SOFT-S}	-0.3 to 9.75	V
Soft-Start Current	I _{SOFT-S}	100	mA
Drive Voltage	V _{DRV}	-0.3 to 9.75	V
Drive Current	I _{DRV}	100	mA
Feedback Voltage	V _{FB}	-0.3 to 9.75	V
Feedback Current	I _{FB}	100	mA
Thermal Resistance, Junction-to-Ambient (0.36 sq in Printed Circuit Copper Clad) (1.0 sq in Printed Circuit Copper Clad)	R _{θJA}	230 200	°C/W
Power Dissipation (T _A = 25°C, 2 oz Cu, 0.36 sq in Printed Circuit Copper Clad)	P _D	0.4	W
Storage Temperature Range	T _{stg}	-65 to 150	°C
Operating Junction Temperature Range	T _J	-40 to 125	°C
Reflow Temperature 10 seconds	T _{reflow}	260	°C

Stresses exceeding Maximum Ratings may damage the device. Maximum Ratings are stress ratings only. Functional operation above the Recommended Operating Conditions is not implied. Extended exposure to stresses above the Recommended Operating Conditions may affect device reliability.

- This device series contains ESD protection and exceeds the following tests:
 Human Body Model (HBM) ±2.0 kV per JEDEC standard: JESD22-A114
 Machine Model (MM) ±200 V per JEDEC standard: JESD22-A115
- Latch-up current maximum rating: ±100 mA per JEDEC standard: JESD78.

NCP102

ELECTRICAL CHARACTERISTICS ($V_{CC} = 12\text{ V}$, $V_{EN} = 1\text{ V}$, $V_{DRV} = V_{FB}$, $V_{SS} = \text{open}$, $C_{CC} = 0.1\ \mu\text{F}$. For typical values $T_J = 25^\circ\text{C}$. For min/max values, $T_J = -40^\circ\text{C}$ to 125°C , unless otherwise noted)

Parameter	Condition		Min	Typ	Max	Unit
-----------	-----------	--	-----	-----	-----	------

POWER SUPPLY

Supply Voltage		V_{CC}	4.5	-	13.5	V
Supply Current	$V_{CC} = 5\text{ V}$	I_{CC1}	-	1.4	3.2	mA
	$V_{CC} = 12\text{ V}$	I_{CC2}	-	1.8	3.2	mA
V_{CC} Startup Voltage	V_{CC} increasing	$V_{CC(\text{on})}$	4.0	4.2	4.5	V
V_{CC} Turn Off Voltage	V_{CC} decreasing	$V_{CC(\text{off})}$	3.8	4.0	4.4	V
V_{CC} Hysteresis	$V_{CC(\text{on})} - V_{CC(\text{off})}$	$V_{CC(\text{hys})}$	0.10	0.24	0.30	V
Standby Current	$V_{EN} = 0\text{ V}$, $V_{CC} = 5\text{ V}$	$I_{CC(\text{off}1)}$	-	0.3	0.8	mA
	$V_{EN} = 0\text{ V}$, $V_{CC} = 12\text{ V}$	$I_{CC(\text{off}2)}$	-	0.48	1.5	mA

ERROR AMPLIFIER

Input Bias Current	$V_{FB} = 1.0\text{ V}$	I_{FB}	-1.0	-	1.0	μA
Open Loop DC Gain (Note 3)		A_v	55	70	-	dB
Unity Gain Bandwidth	$V_{FB} = V_{DRV}$	BW	-	0.7	-	MHz
Power Supply Rejection Ratio (Note 3)	$V_{CC} = 12\text{ V}$, 100 Hz	PSRR	50	-	-	dB

DRIVE

Sink Current		$V_{DRV} = 6\text{ V}$, $V_{FB} = 1\text{ V}$	$I_{DRV(\text{SNK}1)}$	5.0	-	-	mA
		$V_{DRV} = 2.5\text{ V}$, $V_{CC} = 5\text{ V}$, $V_{FB} = 1\text{ V}$	$I_{DRV(\text{SNK}2)}$	5.0	-	-	mA
Source Current		$V_{DRV} = 6\text{ V}$, $V_{FB} = 0.6\text{ V}$	$I_{DRV(\text{SRC}1)}$	5.0	-	-	mA
		$V_{DRV} = 2.5\text{ V}$, $V_{CC} = 5\text{ V}$, $V_{FB} = 0.6\text{ V}$	$I_{DRV(\text{SRC}2)}$	5.0	-	-	mA
Output Voltage	Low State	$I_{DRV} = 5\text{ mA}$, $V_{FB} = 1\text{ V}$	$V_{DRV(\text{low})}$	-	-	0.5	V
	High State	$I_{DRV} = 5\text{ mA}$, $V_{FB} = 0.6\text{ V}$, $V_{CC} = 9.5\text{ V}$	$V_{DRV(\text{high})}$	9.0	-	-	V
Drive Current Under Fault Conditions $T_J = 25^\circ\text{C}$		$V_{DRV} = 0\text{ V}$, $V_{FB} = 0.6\text{ V}$	$I_{DRV(\text{MAX}1)}$	-	-	45	mA
		$V_{DRV} = \text{open}$, $V_{FB} = 0.6\text{ V}$	$I_{DRV(\text{MAX}2)}$	-	-	40	mA

SOFT-START

Source Current	$V_{\text{SOFT-S}} = 1\text{ V}$	$I_{\text{SOFT-S}}$	3.5	4.5	6.2	μA
----------------	----------------------------------	---------------------	-----	-----	-----	---------------

ENABLE

Source Current		I_{EN}	5.0	10	15	μA	
Input Threshold Voltage	On State	V_{EN} Increasing	$V_{EN(\text{on})}$	0.7	0.8	0.9	V
	Off State	V_{EN} Decreasing	$V_{EN(\text{off})}$	0.66	0.77	0.88	V
Threshold Voltage Hysteresis		$V_{EN(\text{on})} - V_{EN(\text{off})}$	$V_{EN(\text{hys})}$	-	35	-	mV

REFERENCE

Reference Voltage	$V_{CC} = 5\text{ V}$, $V_{CC} = 12\text{ V}$	V_{REF}	0.784	0.8	0.816	V
-------------------	--	-----------	-------	-----	-------	---

3. Guaranteed by design.

NCP102

TYPICAL CHARACTERISTICS

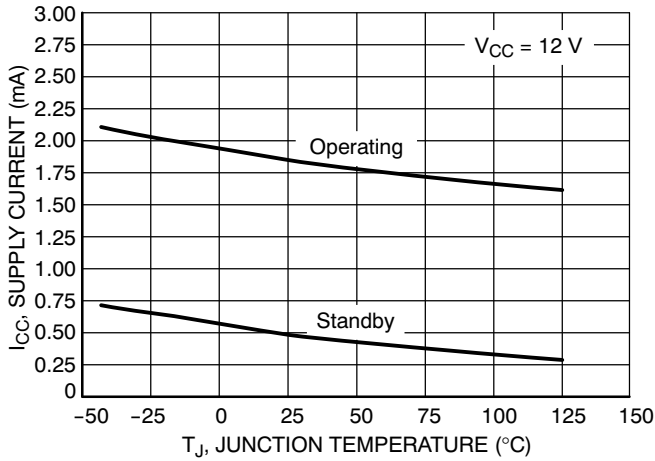

Figure 3. Supply Current vs. Junction Temperature

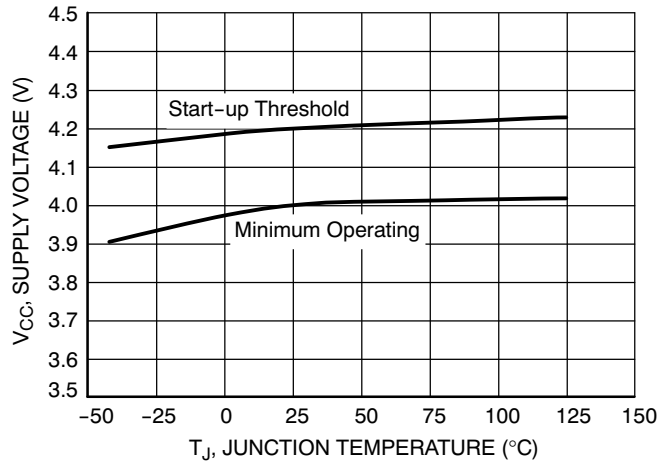

Figure 4. Supply Voltage Thresholds vs. Junction Temperature

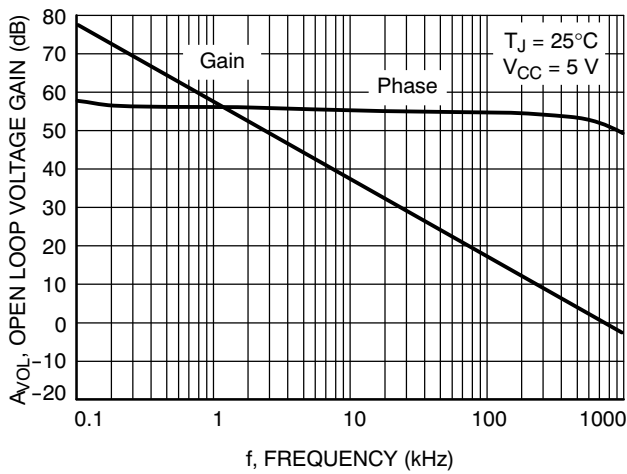

Figure 5. Error Amplifier Open Loop Voltage Gain/Phase vs. Frequency

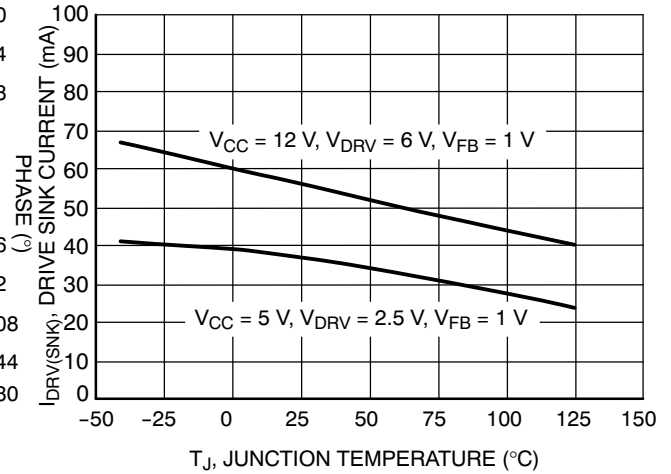

Figure 6. Drive Sink Current vs. Junction Temperature

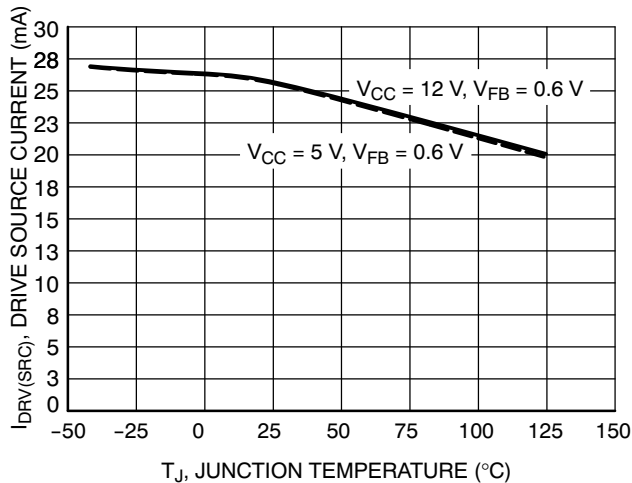

Figure 7. Drive Source Current vs. Junction Temperature

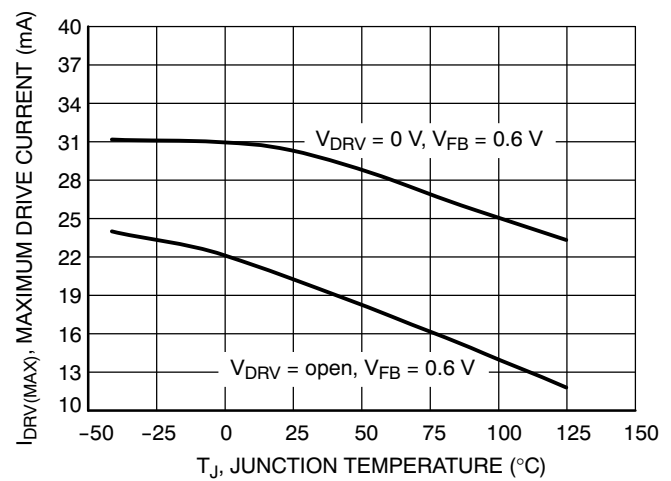

Figure 8. Drive Current Under Fault Conditions vs. Junction Temperature

NCP102

TYPICAL CHARACTERISTICS

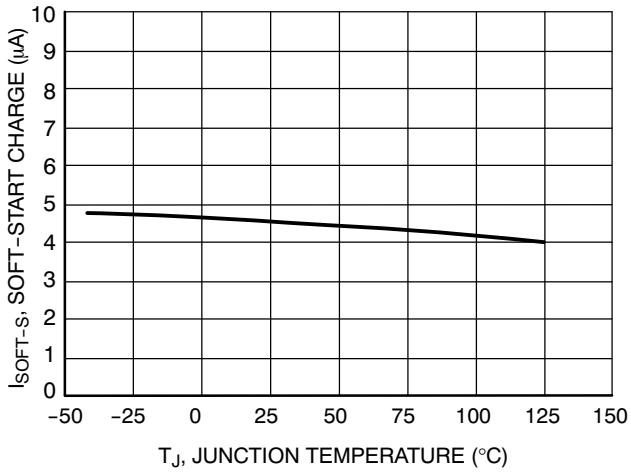

Figure 9. Soft-Start Charge Current vs. Junction Temperature

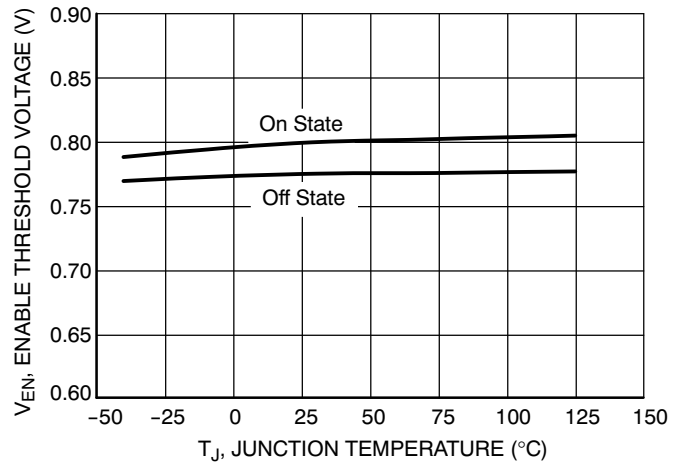

Figure 10. Enable Threshold Voltages vs. Junction Temperature

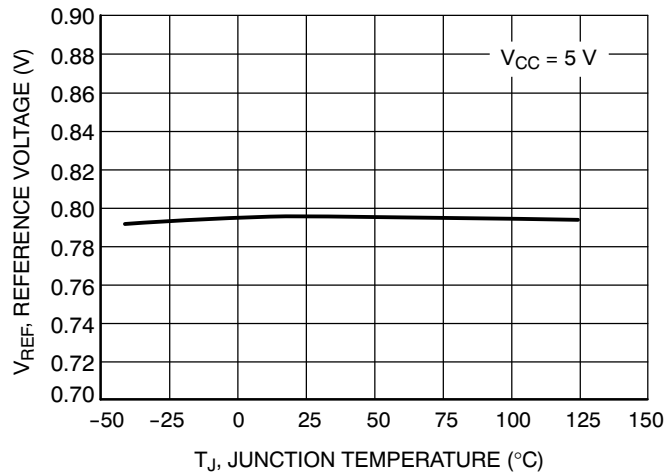

Figure 11. Reference Voltage vs. Junction Temperature

DETAILED OPERATING DESCRIPTION

The NCP102 is a low dropout linear regulator controller for applications requiring high-current and ultra low dropout voltages. The use of an external N-Channel MOSFET allows the user to adapt the device to a multitude of applications depending on system requirements for current and dropout voltage.

An extremely accurate 0.8 V ($\pm 2\%$) reference allows the implementation of sub 1 V voltage supplies. The reference is guaranteed over the complete supply and temperature ranges.

Other features of the NCP102 are a dedicated enable input, internally compensated error amplifier and an adjustable soft-start. A minimum drive capability of ± 5 mA provides fast transient response. The drive current is internally limited to protect the controller in case of an external MOSFET failure. The NCP102 is packaged in a space saving TSOP-6.

SUPPLY VOLTAGE

The NCP102 supply voltage range is between 4.5 V and 13.5 V. The controller is enabled once the supply voltage exceeds its minimum supply threshold, typically 4.5 V. The minimum operating voltage is reduced to 4.2 V (typical) once the controller is enabled to provide noise immunity.

A bypass capacitor is required on the V_{CC} pin to provide charge storage during power up and transient events. A minimum of 0.1 μ F is recommended.

DRIVE OUTPUT

A powerful error amplifier (EA) capable of driving an external MOSFET is built into the NCP102. The output of the error amplifier is connected to the DRV pin. It has a minimum drive current capability of ± 5 mA providing a fast transient response.

The EA is biased directly from V_{CC} . The DRV voltage follows V_{CC} up and it is internally clamped to 9.75 V (typ.). This allows the use of external MOSFETs with a maximum gate voltage of 12 V.

The DRV current is provided directly from V_{CC} . Therefore, the V_{CC} capacitor should be large enough to maintain a constant V_{CC} during power up and transients. Otherwise, the supply voltage may collapse reaching the controller undervoltage lockout threshold.

INTERNAL REFERENCE

The internal 0.8 V reference facilitates the implementation of sub 1 V supplies required in modern computing equipment. The internal reference is trimmed during manufacturing to obtain better than $\pm 2\%$ accuracy over the complete operating range.

The output voltage, V_{out} , is programmed using a resistor divider (R1 and R2) as shown in Figure 1.

The resistor divider senses the output voltage and compares it to the internal 0.8 V reference.

Equation 1 relates the output voltage to the internal reference voltage and external resistors R1 and R2.

$$V_{out} = V_{REF} \cdot \left(\frac{R1 + R2}{R2} \right) \quad (\text{eq. 1})$$

ERROR AMPLIFIER

The NCP102 has a wide bandwidth error amplifier. It allows the user to implement a wide bandwidth feedback loop resulting in better transient response and lower system cost. It requires the user to compensate the system. A narrow bandwidth error amplifier usually does not require external compensation but it requires more output capacitance to meet typical transient requirements.

The output of the error amplifier is available for frequency compensation. A capacitor (C_{COMP}) can be placed between the DRV and FB pins. In most cases the resistor is not needed. The uncompensated error amplifier dominant pole is approximately 1.65 Hz. Any external capacitance between the DRV and FB pins reduces the dominant pole frequency due to the Miller multiplication effect. Equation 2 relates the dominant pole frequency to C_{COMP} .

$$f_{pole} = 6.7016 \cdot C_{COMP}^{-0.846} \quad (\text{eq. 2})$$

EXTERNAL ENABLE

The EN input allows the NCP102 to be remotely enabled. An internal 10 μ A (typ.) current source pulls up the EN voltage. The EN pin is internally pulled to V_{CC} or 9.5 V, whichever is lower.

The controller is enabled once the EN pin voltage exceeds 0.8 V (typ.). The controller is disabled by pulling down on the EN pin. Figure 12 shows the relationship between enable and soft-start.

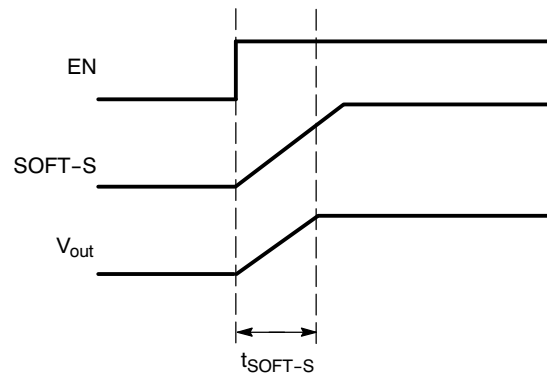

Figure 12. Relationship Between Enable and Soft-Start

The EN pin can be connected to V_{CC} if the enable feature is not used. If connected to V_{CC} and V_{CC} is higher than 9.5 V a resistor in series should be used to limit the current into the EN pin as the pin is internally clamped to 9.5 V. A minimum of 40 k Ω is recommended.

MECHANICAL CASE OUTLINE

PACKAGE DIMENSIONS

ON Semiconductor®



SCALE 2:1

TSOP-6 CASE 318G-02 ISSUE V

DATE 12 JUN 2012

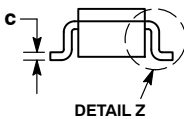
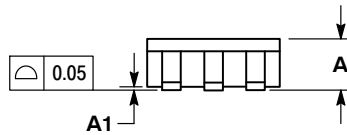
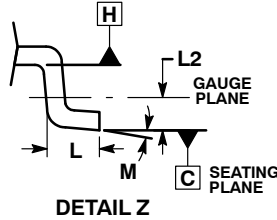
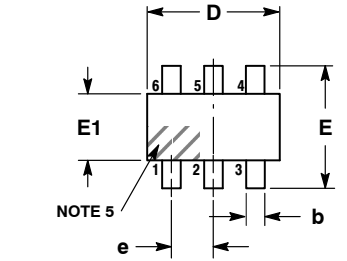

NOTES:

1. DIMENSIONING AND TOLERANCING PER ASME Y14.5M, 1994.
2. CONTROLLING DIMENSION: MILLIMETERS.
3. MAXIMUM LEAD THICKNESS INCLUDES LEAD FINISH. MINIMUM LEAD THICKNESS IS THE MINIMUM THICKNESS OF BASE MATERIAL.
4. DIMENSIONS D AND E1 DO NOT INCLUDE MOLD FLASH, PROTRUSIONS, OR GATE BURRS. MOLD FLASH, PROTRUSIONS, OR GATE BURRS SHALL NOT EXCEED 0.15 PER SIDE. DIMENSIONS D AND E1 ARE DETERMINED AT DATUM H.
5. PIN ONE INDICATOR MUST BE LOCATED IN THE INDICATED ZONE.

DIM	MILLIMETERS		
	MIN	NOM	MAX
A	0.90	1.00	1.10
A1	0.01	0.06	0.10
b	0.25	0.38	0.50
c	0.10	0.18	0.26
D	2.90	3.00	3.10
E	2.50	2.75	3.00
E1	1.30	1.50	1.70
e	0.85	0.95	1.05
L	0.20	0.40	0.60
L2	0.25 BSC		
M	0°	-	10°

STYLE 1:

- PIN 1. DRAIN
- 2. DRAIN
- 3. GATE
- 4. SOURCE
- 5. DRAIN
- 6. DRAIN

STYLE 2:

- PIN 1. EMITTER 2
- 2. BASE 1
- 3. COLLECTOR 1
- 4. EMITTER 1
- 5. BASE 2
- 6. COLLECTOR 2

STYLE 3:

- PIN 1. ENABLE
- 2. N/C
- 3. R BOOST
- 4. Vz
- 5. V in
- 6. V out

STYLE 4:

- PIN 1. N/C
- 2. V in
- 3. NOT USED
- 4. GROUND
- 5. ENABLE
- 6. LOAD

STYLE 5:

- PIN 1. EMITTER 2
- 2. BASE 2
- 3. COLLECTOR 1
- 4. EMITTER 1
- 5. BASE 1
- 6. COLLECTOR 2

STYLE 6:

- PIN 1. COLLECTOR
- 2. COLLECTOR
- 3. BASE
- 4. EMITTER
- 5. COLLECTOR
- 6. COLLECTOR

STYLE 7:

- PIN 1. COLLECTOR
- 2. COLLECTOR
- 3. BASE
- 4. N/C
- 5. COLLECTOR
- 6. EMITTER

STYLE 8:

- PIN 1. Vbus
- 2. D(in)
- 3. D(in)+
- 4. D(out)+
- 5. D(out)
- 6. GND

STYLE 9:

- PIN 1. LOW VOLTAGE GATE
- 2. DRAIN
- 3. SOURCE
- 4. DRAIN
- 5. DRAIN
- 6. HIGH VOLTAGE GATE

STYLE 10:

- PIN 1. D(OUT)+
- 2. GND
- 3. D(OUT)-
- 4. D(IN)-
- 5. VBUS
- 6. D(IN)+

STYLE 11:

- PIN 1. SOURCE 1
- 2. DRAIN 2
- 3. DRAIN 2
- 4. SOURCE 2
- 5. GATE 1
- 6. DRAIN 1/GATE 2

STYLE 12:

- PIN 1. I/O
- 2. GROUND
- 3. I/O
- 4. I/O
- 5. VCC
- 6. I/O

STYLE 13:

- PIN 1. GATE 1
- 2. SOURCE 2
- 3. GATE 2
- 4. DRAIN 2
- 5. SOURCE 1
- 6. DRAIN 1

STYLE 14:

- PIN 1. ANODE
- 2. SOURCE
- 3. GATE
- 4. CATHODE/DRAIN
- 5. CATHODE/DRAIN
- 6. CATHODE/DRAIN

STYLE 15:

- PIN 1. ANODE
- 2. SOURCE
- 3. GATE
- 4. DRAIN
- 5. N/C
- 6. CATHODE

STYLE 16:

- PIN 1. ANODE/CATHODE
- 2. BASE
- 3. EMITTER
- 4. COLLECTOR
- 5. ANODE
- 6. CATHODE

STYLE 17:

- PIN 1. EMITTER
- 2. BASE
- 3. ANODE/CATHODE
- 4. ANODE
- 5. CATHODE
- 6. COLLECTOR

RECOMMENDED SOLDERING FOOTPRINT*

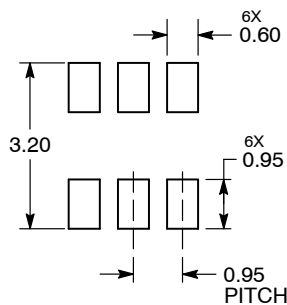

DIMENSIONS: MILLIMETERS

GENERIC MARKING DIAGRAM*

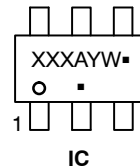

IC

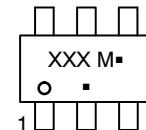

STANDARD

- XXX = Specific Device Code
- A = Assembly Location
- Y = Year
- W = Work Week
- = Pb-Free Package

- XXX = Specific Device Code
- M = Date Code
- = Pb-Free Package

*For additional information on our Pb-Free strategy and soldering details, please download the ON Semiconductor Soldering and Mounting Techniques Reference Manual, SOLDERRM/D.

*This information is generic. Please refer to device data sheet for actual part marking. Pb-Free indicator, "G" or microdot "▪", may or may not be present.

DOCUMENT NUMBER:	98ASB14888C	Electronic versions are uncontrolled except when accessed directly from the Document Repository. Printed versions are uncontrolled except when stamped "CONTROLLED COPY" in red.
DESCRIPTION:	TSOP-6	PAGE 1 OF 1

ON Semiconductor and ON are trademarks of Semiconductor Components Industries, LLC dba ON Semiconductor or its subsidiaries in the United States and/or other countries. ON Semiconductor reserves the right to make changes without further notice to any products herein. ON Semiconductor makes no warranty, representation or guarantee regarding the suitability of its products for any particular purpose, nor does ON Semiconductor assume any liability arising out of the application or use of any product or circuit, and specifically disclaims any and all liability, including without limitation special, consequential or incidental damages. ON Semiconductor does not convey any license under its patent rights nor the rights of others.

onsemi, **Onsemi**, and other names, marks, and brands are registered and/or common law trademarks of Semiconductor Components Industries, LLC dba "**onsemi**" or its affiliates and/or subsidiaries in the United States and/or other countries. **onsemi** owns the rights to a number of patents, trademarks, copyrights, trade secrets, and other intellectual property. A listing of **onsemi**'s product/patent coverage may be accessed at www.onsemi.com/site/pdf/Patent-Marking.pdf. **onsemi** reserves the right to make changes at any time to any products or information herein, without notice. The information herein is provided "as-is" and **onsemi** makes no warranty, representation or guarantee regarding the accuracy of the information, product features, availability, functionality, or suitability of its products for any particular purpose, nor does **onsemi** assume any liability arising out of the application or use of any product or circuit, and specifically disclaims any and all liability, including without limitation special, consequential or incidental damages. Buyer is responsible for its products and applications using **onsemi** products, including compliance with all laws, regulations and safety requirements or standards, regardless of any support or applications information provided by **onsemi**. "Typical" parameters which may be provided in **onsemi** data sheets and/or specifications can and do vary in different applications and actual performance may vary over time. All operating parameters, including "Typicals" must be validated for each customer application by customer's technical experts. **onsemi** does not convey any license under any of its intellectual property rights nor the rights of others. **onsemi** products are not designed, intended, or authorized for use as a critical component in life support systems or any FDA Class 3 medical devices or medical devices with a same or similar classification in a foreign jurisdiction or any devices intended for implantation in the human body. Should Buyer purchase or use **onsemi** products for any such unintended or unauthorized application, Buyer shall indemnify and hold **onsemi** and its officers, employees, subsidiaries, affiliates, and distributors harmless against all claims, costs, damages, and expenses, and reasonable attorney fees arising out of, directly or indirectly, any claim of personal injury or death associated with such unintended or unauthorized use, even if such claim alleges that **onsemi** was negligent regarding the design or manufacture of the part. **onsemi** is an Equal Opportunity/Affirmative Action Employer. This literature is subject to all applicable copyright laws and is not for resale in any manner.

PUBLICATION ORDERING INFORMATION

LITERATURE FULFILLMENT:

Email Requests to: orderlit@onsemi.com

onsemi Website: www.onsemi.com

TECHNICAL SUPPORT

North American Technical Support:

Voice Mail: 1 800-282-9855 Toll Free USA/Canada

Phone: 011 421 33 790 2910

Europe, Middle East and Africa Technical Support:

Phone: 00421 33 790 2910

For additional information, please contact your local Sales Representative