

NB2872A

Low Power, Reduced EMI Clock Synthesizer

The NB2872A is a versatile spread spectrum frequency modulator designed specifically for a wide range of clock frequencies. The NB2872A reduces ElectroMagnetic Interference (EMI) at the clock source, allowing system wide reduction of EMI of all clock dependent signals. The NB2872A allows significant system cost savings by reducing the number of circuit board layers, ferrite beads and shielding that are traditionally required to pass EMI regulations.

The NB2872A uses the most efficient and optimized modulation profile approved by the FCC and is implemented by using a proprietary all digital method.

The NB2872A modulates the output of a single PLL in order to “spread” the bandwidth of a synthesized clock, and more importantly, decreases the peak amplitudes of its harmonics. This results in significantly lower system EMI compared to the typical narrow band signal produced by oscillators and most frequency generators. Lowering EMI by increasing a signal’s bandwidth is called ‘spread spectrum clock generation’.

The NB2872A is targeted towards all portable devices with very low power requirements like MP3 players, Notebooks and digital still cameras.

Features

- Generates an EMI Optimized Clocking Signal at the Output
- Integrated Loop Filter Components
- Operates with a 3.3 V \pm 0.3 V Supply
- Operating Current less than 6.0 mA
- Low Power CMOS Design
- Input Frequency Range: 15 MHz to 30 MHz
- Generates a 1X Low EMI Spread Spectrum clock of the Input Frequency
- Frequency Deviation -1.25%
- Available in TSOP-6 Package (TSOT-23-6)
- Pb-Free Package is Available



ON Semiconductor®

<http://onsemi.com>

MARKING DIAGRAM*



TSOP-6
(TSOT-23-6)
SN SUFFIX
CASE 318G

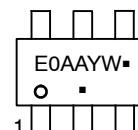

E0A = Specific Device Code
A = Assembly Location
Y = Year
W = Work Week
▪ = Pb-Free Package

(Note: Microdot may be in either location)

*For additional marking information, refer to Application Note AND8002/D.

ORDERING INFORMATION

See detailed ordering and shipping information in the package dimensions section on page 5 of this data sheet.

NB2872A

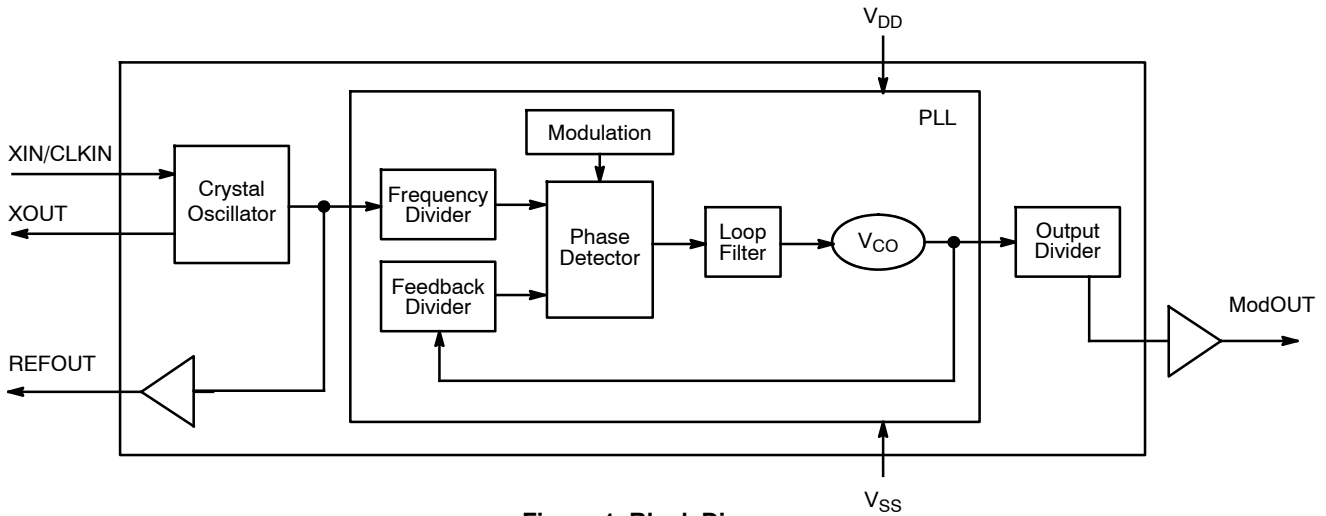

Figure 1. Block Diagram

Table 1. KEY SPECIFICATIONS

Description	Specification
Supply Voltages	$V_{DD} = 3.3\text{ V} \pm 10\%$
Frequency Range	$15\text{ MHz} < \text{CLKIN} < 30\text{ MHz}$
Cycle-to-Cycle Jitter	300 ps (maximum)
Output Duty Cycle	40 / 60% (worst case)
Output Rise and Fall Times	1.1 ns (maximum)
Modulation Equation	$F_{IN}/640$
Frequency Deviation	-1.25%

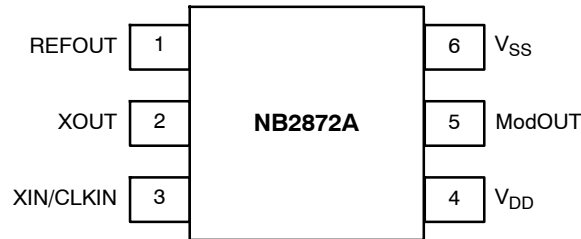

Figure 2. Pin Configuration

Table 2. PIN DESCRIPTION

Pin #	Pin Name	Type	Description
1	REFOUT	O	Buffered output of the input frequency.
2	XOUT	O	Crystal connection. If using an external reference, this pin must be left unconnected.
3	XIN/CLKIN	I	Crystal connection or external reference frequency input. This pin has dual functions. It can be connected either to an external crystal or an external reference clock
4	V_{DD}	P	Power supply for the entire chip (3.3 V).
5	ModOUT	O	Spread spectrum clock output.
6	V_{SS}	P	Ground connection.

NB2872A

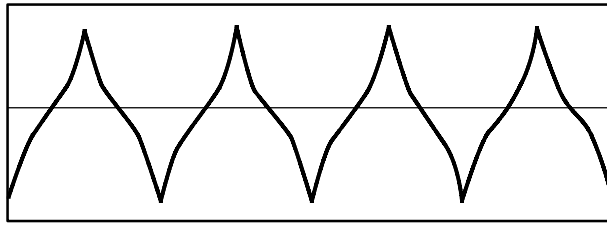

Figure 3. Modulation Profile

Table 3. MAXIMUM RATINGS

Symbol	Description	Rating	Unit
V_{DD}, V_{IN}	Voltage on any pin with respect to Ground	0.5 to + 7.0	V
T_{STG}	Storage Temperature	-65 to +125	°C
T_A	Operating Temperature	0 to 70	°C

Stresses exceeding Maximum Ratings may damage the device. Maximum Ratings are stress ratings only. Functional operation above the Recommended Operating Conditions is not implied. Extended exposure to stresses above the Recommended Operating Conditions may affect device reliability.

Table 4. DC ELECTRICAL CHARACTERISTICS (Test Conditions: All parameters are measured at room temperature 25°C)

Symbol	Description	Min	Typ	Max	Unit
V_{IL}	Input LOW Voltage	GND - 0.3		0.8	V
V_{IH}	Input HIGH Voltage	2.0		$V_{DD} + 0.3$	V
I_{IL}	Input LOW Current			-35	μA
I_{IH}	Input HIGH Current			35	μA
I_{XOL}	XOUT Output LOW Current (@ 4.0 V, $V_{DD} = 3.3$ V)		3		mA
I_{XOH}	XOUT Output HIGH Current (@ 2.5 V, $V_{DD} = 3.3$ V)		3		mA
V_{OL}	Output LOW Voltage ($V_{DD} = 3.3$ V, $I_{OL} = 20$ mA)			0.4	V
V_{OH}	Output HIGH Voltage ($V_{DD} = 3.3$ V, $I_{OH} = 20$ mA)	2.5			V
I_{DD}	Static Supply Current (Note 1)			1.5	mA
I_{CC}	Dynamic Supply Current (3.3 V, 30 MHz, and 15 pF loading)			6	mA
V_{DD}	Operating Voltage	3.0	3.3	3.6	V
t_{ON}	Powerup Time (first locked cycle after powerup) (Note 2)			10	mS
Z_{OUT}	Clock Output Impedance		50		Ω

NOTE: Device will meet the specifications after thermal equilibrium has been established when mounted in a test socket or printed circuit board with maintained transverse airflow greater than 500 lfm. Electrical parameters are guaranteed only over the declared operating temperature range. Functional operation of the device exceeding these conditions is not implied. Device specification limit values are applied individually under normal operating conditions and not valid simultaneously.

1. XIN/CLKIN pin is pulled low.
2. V_{DD} and XIN/CLKIN input are stable.

NB2872A

Table 5. AC ELECTRICAL CHARACTERISTICS

Symbol	Description	Min	Typ	Max	Unit
CLKIN	Input Frequency	15		30	MHz
ModOUT	Output Frequency	15		30	MHz
REFOUT	Output Frequency	15		30	MHz
t_{LH} (Note 3)	Output Rise Time (measured at 0.8 V to 2.0 V)	0.5	0.7	1.1	ns
t_{HL} (Note 3)	Output Fall Time (measured at 2.0 V to 0.8 V)	0.5	0.7	1.0	ns
t_{JC}	Jitter (Cycle-to-Cycle)			360	ps
t_D	Output Duty Cycle	45	50	55	%

NOTE: Device will meet the specifications after thermal equilibrium has been established when mounted in a test socket or printed circuit board with maintained transverse airflow greater than 500 lpm. Electrical parameters are guaranteed only over the declared operating temperature range. Functional operation of the device exceeding these conditions is not implied. Device specification limit values are applied individually under normal operating conditions and not valid simultaneously.

3. t_{LH} and t_{HL} are measured at capacitive load of 15 pF.

NB2872A

ORDERING INFORMATION

Device	Marking	Temperature Range	Package	Shipping [†]	Availability
NB2872ASNR2	E0A	0°C - 70°C	TSOP-6 (TSOT-23-6)	2500 Tape & Reel	<i>Now</i>
NB2872ASNR2G	E0A	0°C - 70°C	TSOP-6 (TSOT-23-6) (Pb-Free)	2500 Tape & Reel	<i>Contact Sales Representative</i>

[†]For information on tape and reel specifications, including part orientation and tape sizes, please refer to our Tape and Reel Packaging Specifications Brochure, BRD8011/D.

MECHANICAL CASE OUTLINE

PACKAGE DIMENSIONS

ON Semiconductor®



SCALE 2:1

TSOP-6 CASE 318G-02 ISSUE V

DATE 12 JUN 2012

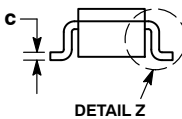
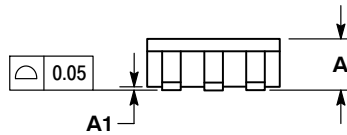
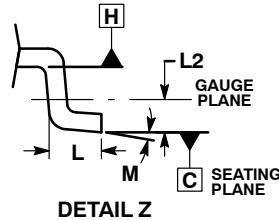
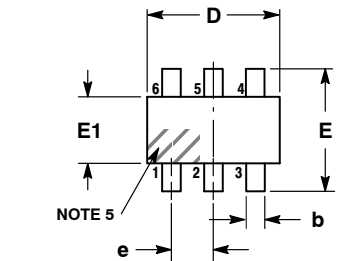

NOTES:

1. DIMENSIONING AND TOLERANCING PER ASME Y14.5M, 1994.
2. CONTROLLING DIMENSION: MILLIMETERS.
3. MAXIMUM LEAD THICKNESS INCLUDES LEAD FINISH. MINIMUM LEAD THICKNESS IS THE MINIMUM THICKNESS OF BASE MATERIAL.
4. DIMENSIONS D AND E1 DO NOT INCLUDE MOLD FLASH, PROTRUSIONS, OR GATE BURRS. MOLD FLASH, PROTRUSIONS, OR GATE BURRS SHALL NOT EXCEED 0.15 PER SIDE. DIMENSIONS D AND E1 ARE DETERMINED AT DATUM H.
5. PIN ONE INDICATOR MUST BE LOCATED IN THE INDICATED ZONE.

DIM	MILLIMETERS		
	MIN	NOM	MAX
A	0.90	1.00	1.10
A1	0.01	0.06	0.10
b	0.25	0.38	0.50
c	0.10	0.18	0.26
D	2.90	3.00	3.10
E	2.50	2.75	3.00
E1	1.30	1.50	1.70
e	0.85	0.95	1.05
L	0.20	0.40	0.60
L2	0.25 BSC		
M	0°	-	10°

- | | | | | | |
|--|--|---|---|---|--|
| <p>STYLE 1:
PIN 1. DRAIN
2. DRAIN
3. GATE
4. SOURCE
5. DRAIN
6. DRAIN</p> | <p>STYLE 2:
PIN 1. EMITTER 2
2. BASE 1
3. COLLECTOR 1
4. EMITTER 1
5. BASE 2
6. COLLECTOR 2</p> | <p>STYLE 3:
PIN 1. ENABLE
2. N/C
3. R BOOST
4. Vz
5. V in
6. V out</p> | <p>STYLE 4:
PIN 1. N/C
2. V in
3. NOT USED
4. GROUND
5. ENABLE
6. LOAD</p> | <p>STYLE 5:
PIN 1. EMITTER 2
2. BASE 2
3. COLLECTOR 1
4. EMITTER 1
5. BASE 1
6. COLLECTOR 2</p> | <p>STYLE 6:
PIN 1. COLLECTOR
2. COLLECTOR
3. BASE
4. EMITTER
5. COLLECTOR
6. COLLECTOR</p> |
| <p>STYLE 7:
PIN 1. COLLECTOR
2. COLLECTOR
3. BASE
4. N/C
5. COLLECTOR
6. EMITTER</p> | <p>STYLE 8:
PIN 1. Vbus
2. D(in)
3. D(in)+
4. D(out)+
5. D(out)
6. GND</p> | <p>STYLE 9:
PIN 1. LOW VOLTAGE GATE
2. DRAIN
3. SOURCE
4. DRAIN
5. DRAIN
6. HIGH VOLTAGE GATE</p> | <p>STYLE 10:
PIN 1. D(OUT)+
2. GND
3. D(OUT)-
4. D(IN)-
5. VBUS
6. D(IN)+</p> | <p>STYLE 11:
PIN 1. SOURCE 1
2. DRAIN 2
3. DRAIN 2
4. SOURCE 2
5. GATE 1
6. DRAIN 1/GATE 2</p> | <p>STYLE 12:
PIN 1. I/O
2. GROUND
3. I/O
4. I/O
5. VCC
6. I/O</p> |
| <p>STYLE 13:
PIN 1. GATE 1
2. SOURCE 2
3. GATE 2
4. DRAIN 2
5. SOURCE 1
6. DRAIN 1</p> | <p>STYLE 14:
PIN 1. ANODE
2. SOURCE
3. GATE
4. CATHODE/DRAIN
5. CATHODE/DRAIN
6. CATHODE/DRAIN</p> | <p>STYLE 15:
PIN 1. ANODE
2. SOURCE
3. GATE
4. DRAIN
5. N/C
6. CATHODE</p> | <p>STYLE 16:
PIN 1. ANODE/CATHODE
2. BASE
3. EMITTER
4. COLLECTOR
5. ANODE
6. CATHODE</p> | <p>STYLE 17:
PIN 1. EMITTER
2. BASE
3. ANODE/CATHODE
4. ANODE
5. CATHODE
6. COLLECTOR</p> | |

RECOMMENDED SOLDERING FOOTPRINT*

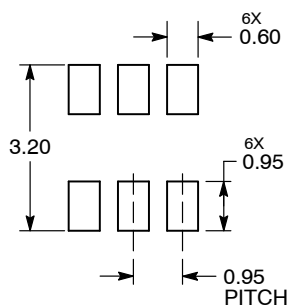

DIMENSIONS: MILLIMETERS

GENERIC MARKING DIAGRAM*



- | | |
|----------------------------|----------------------------|
| XXX = Specific Device Code | XXX = Specific Device Code |
| A = Assembly Location | M = Date Code |
| Y = Year | ◻ = Pb-Free Package |
| W = Work Week | |
| ◻ = Pb-Free Package | |

*For additional information on our Pb-Free strategy and soldering details, please download the ON Semiconductor Soldering and Mounting Techniques Reference Manual, SOLDERRM/D.

*This information is generic. Please refer to device data sheet for actual part marking. Pb-Free indicator, "G" or microdot "▪", may or may not be present.

DOCUMENT NUMBER:	98ASB14888C	Electronic versions are uncontrolled except when accessed directly from the Document Repository. Printed versions are uncontrolled except when stamped "CONTROLLED COPY" in red.
DESCRIPTION:	TSOP-6	PAGE 1 OF 1

ON Semiconductor and ON are trademarks of Semiconductor Components Industries, LLC dba ON Semiconductor or its subsidiaries in the United States and/or other countries. ON Semiconductor reserves the right to make changes without further notice to any products herein. ON Semiconductor makes no warranty, representation or guarantee regarding the suitability of its products for any particular purpose, nor does ON Semiconductor assume any liability arising out of the application or use of any product or circuit, and specifically disclaims any and all liability, including without limitation special, consequential or incidental damages. ON Semiconductor does not convey any license under its patent rights nor the rights of others.

onsemi, **Onsemi**, and other names, marks, and brands are registered and/or common law trademarks of Semiconductor Components Industries, LLC dba "**onsemi**" or its affiliates and/or subsidiaries in the United States and/or other countries. **onsemi** owns the rights to a number of patents, trademarks, copyrights, trade secrets, and other intellectual property. A listing of **onsemi**'s product/patent coverage may be accessed at www.onsemi.com/site/pdf/Patent-Marking.pdf. **onsemi** reserves the right to make changes at any time to any products or information herein, without notice. The information herein is provided "as-is" and **onsemi** makes no warranty, representation or guarantee regarding the accuracy of the information, product features, availability, functionality, or suitability of its products for any particular purpose, nor does **onsemi** assume any liability arising out of the application or use of any product or circuit, and specifically disclaims any and all liability, including without limitation special, consequential or incidental damages. Buyer is responsible for its products and applications using **onsemi** products, including compliance with all laws, regulations and safety requirements or standards, regardless of any support or applications information provided by **onsemi**. "Typical" parameters which may be provided in **onsemi** data sheets and/or specifications can and do vary in different applications and actual performance may vary over time. All operating parameters, including "Typicals" must be validated for each customer application by customer's technical experts. **onsemi** does not convey any license under any of its intellectual property rights nor the rights of others. **onsemi** products are not designed, intended, or authorized for use as a critical component in life support systems or any FDA Class 3 medical devices or medical devices with a same or similar classification in a foreign jurisdiction or any devices intended for implantation in the human body. Should Buyer purchase or use **onsemi** products for any such unintended or unauthorized application, Buyer shall indemnify and hold **onsemi** and its officers, employees, subsidiaries, affiliates, and distributors harmless against all claims, costs, damages, and expenses, and reasonable attorney fees arising out of, directly or indirectly, any claim of personal injury or death associated with such unintended or unauthorized use, even if such claim alleges that **onsemi** was negligent regarding the design or manufacture of the part. **onsemi** is an Equal Opportunity/Affirmative Action Employer. This literature is subject to all applicable copyright laws and is not for resale in any manner.

PUBLICATION ORDERING INFORMATION

LITERATURE FULFILLMENT:

Email Requests to: orderlit@onsemi.com

onsemi Website: www.onsemi.com

TECHNICAL SUPPORT

North American Technical Support:

Voice Mail: 1 800-282-9855 Toll Free USA/Canada

Phone: 011 421 33 790 2910

Europe, Middle East and Africa Technical Support:

Phone: 00421 33 790 2910

For additional information, please contact your local Sales Representative