

MPS2907A Series

General Purpose Transistors

PNP Silicon

Features

- These are Pb-Free Devices*

MAXIMUM RATINGS

Rating	Symbol	Value	Unit
Collector - Emitter Voltage	V_{CEO}	-60	Vdc
Collector - Base Voltage	V_{CBO}	-60	Vdc
Emitter - Base Voltage	V_{EBO}	-5.0	Vdc
Collector Current - Continuous	I_C	-600	mAdc
Total Device Dissipation @ $T_A = 25^\circ\text{C}$ Derate above 25°C	P_D	625 5.0	mW mW/ $^\circ\text{C}$
Total Device Dissipation @ $T_C = 25^\circ\text{C}$ Derate above 25°C	P_D	1.5 12	W mW/ $^\circ\text{C}$
Operating and Storage Junction Temperature Range	T_J, T_{stg}	-55 to +150	$^\circ\text{C}$

THERMAL CHARACTERISTICS

Characteristic	Symbol	Max	Unit
Thermal Resistance, Junction-to-Ambient	$R_{\theta JA}$	200	$^\circ\text{C}/\text{W}$
Thermal Resistance, Junction-to-Case	$R_{\theta JC}$	83.3	$^\circ\text{C}/\text{W}$

Stresses exceeding Maximum Ratings may damage the device. Maximum Ratings are stress ratings only. Functional operation above the Recommended Operating Conditions is not implied. Extended exposure to stresses above the Recommended Operating Conditions may affect device reliability.

DEVICE MARKING

Device	Line 1	Line 2
MPS2907AG	MPS	2907A
MPS2907ARLG	MPS2	907A
MPS2907ARLRAG	MPS	2907
MPS2907ARLRPG	MPS	2907

*For additional information on our Pb-Free strategy and soldering details, please download the ON Semiconductor Soldering and Mounting Techniques Reference Manual, SOLDERRM/D.



ON Semiconductor®

<http://onsemi.com>

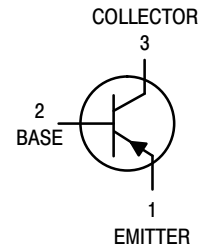

TO-92
CASE 29
STYLE 1

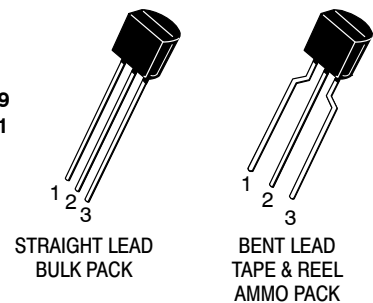

MARKING DIAGRAM

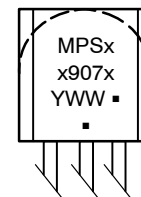

Y = Year
WW = Work Week
▪ = Pb-Free Package
(Note: Microdot may be in either location)

ORDERING INFORMATION

See detailed ordering and shipping information in the package dimensions section on page 4 of this data sheet.

MPS2907A Series

ELECTRICAL CHARACTERISTICS ($T_A = 25^\circ\text{C}$ unless otherwise noted)

Characteristic	Symbol	Min	Max	Unit	
OFF CHARACTERISTICS					
Collector – Emitter Breakdown Voltage (Note 1) ($I_C = -10\text{ mAdc}$, $I_B = 0$)	$V_{(BR)CEO}$	-60	-	Vdc	
Collector – Base Breakdown Voltage ($I_C = -10\ \mu\text{Adc}$, $I_E = 0$)	$V_{(BR)CBO}$	-60	-	Vdc	
Emitter – Base Breakdown Voltage ($I_E = -10\ \mu\text{Adc}$, $I_C = 0$)	$V_{(BR)EBO}$	-5.0	-	Vdc	
Collector Cutoff Current ($V_{CE} = -30\text{ Vdc}$, $V_{EB(off)} = -0.5\text{ Vdc}$)	I_{CEX}	-	-50	nAdc	
Collector Cutoff Current ($V_{CB} = -50\text{ Vdc}$, $I_E = 0$) ($V_{CB} = -50\text{ Vdc}$, $I_E = 0$, $T_A = 150^\circ\text{C}$)	I_{CBO}	-	-0.01 -10	μAdc	
Base Current ($V_{CE} = -30\text{ Vdc}$, $V_{EB(off)} = -0.5\text{ Vdc}$)	I_B	-	-50	nAdc	
ON CHARACTERISTICS					
DC Current Gain ($I_C = -0.1\text{ mAdc}$, $V_{CE} = -10\text{ Vdc}$) ($I_C = -1.0\text{ mAdc}$, $V_{CE} = -10\text{ Vdc}$) ($I_C = -10\text{ mAdc}$, $V_{CE} = -10\text{ Vdc}$) ($I_C = -150\text{ mAdc}$, $V_{CE} = -10\text{ Vdc}$) (Note 1) ($I_C = -500\text{ mAdc}$, $V_{CE} = -10\text{ Vdc}$) (Note 1)	h_{FE}	75 100 100 100 50	- - - 300 -	-	
Collector – Emitter Saturation Voltage (Note 1) ($I_C = -150\text{ mAdc}$, $I_B = -15\text{ mAdc}$) ($I_C = -500\text{ mAdc}$, $I_B = -50\text{ mAdc}$)	$V_{CE(sat)}$	- -	-0.4 -1.6	Vdc	
Base – Emitter Saturation Voltage (Note 1) ($I_C = -150\text{ mAdc}$, $I_B = -15\text{ mAdc}$) ($I_C = -500\text{ mAdc}$, $I_B = -50\text{ mAdc}$)	$V_{BE(sat)}$	- -	-1.3 -2.6	Vdc	
SMALL – SIGNAL CHARACTERISTICS					
Current – Gain – Bandwidth Product (Notes 1 and 2), ($I_C = -50\text{ mAdc}$, $V_{CE} = -20\text{ Vdc}$, $f = 100\text{ MHz}$)	f_T	200	-	MHz	
Output Capacitance ($V_{CB} = -10\text{ Vdc}$, $I_E = 0$, $f = 1.0\text{ MHz}$)	C_{obo}	-	8.0	pF	
Input Capacitance ($V_{EB} = -2.0\text{ Vdc}$, $I_C = 0$, $f = 1.0\text{ MHz}$)	C_{ibo}	-	30	pF	
SWITCHING CHARACTERISTICS					
Turn-On Time	$(V_{CC} = -30\text{ Vdc}$, $I_C = -150\text{ mAdc}$, $I_{B1} = -15\text{ mAdc}$) (Figures 1 and 5)	t_{on}	-	45	ns
Delay Time		t_d	-	10	ns
Rise Time		t_r	-	40	ns
Turn-Off Time	$(V_{CC} = -6.0\text{ Vdc}$, $I_C = -150\text{ mAdc}$, $I_{B1} = I_{B2} = 15\text{ mAdc}$) (Figure 2)	t_{off}	-	100	ns
Storage Time		t_s	-	80	ns
Fall Time		t_f	-	30	ns

1. Pulse Test: Pulse Width $\leq 300\ \mu\text{s}$, Duty Cycle $\leq 2\%$.
2. f_T is defined as the frequency at which $|h_{fe}|$ extrapolates to unity.

MPS2907A Series

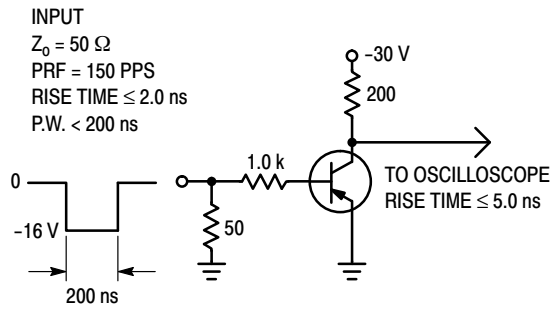

Figure 1. Delay and Rise Time Test Circuit

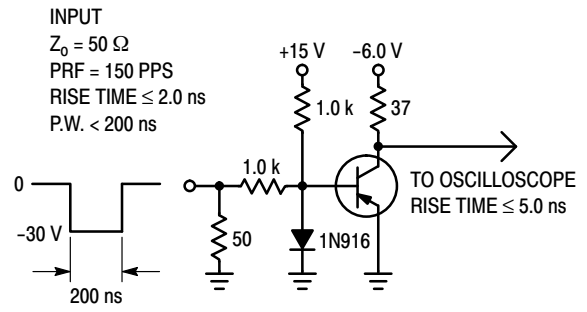

Figure 2. Storage and Fall Time Test Circuit

TYPICAL CHARACTERISTICS

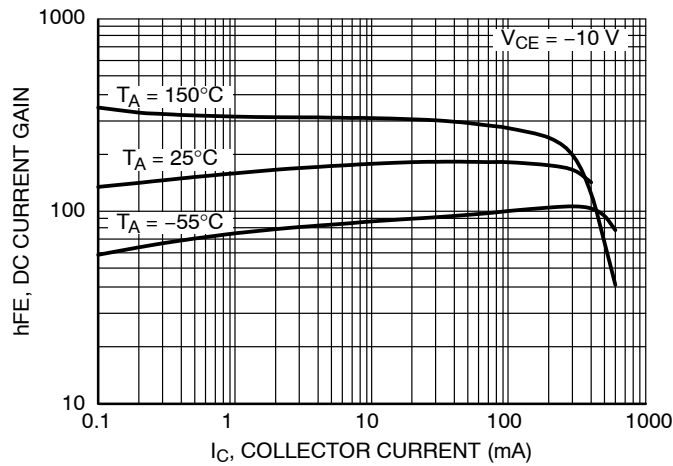

Figure 3. DC Current Gain

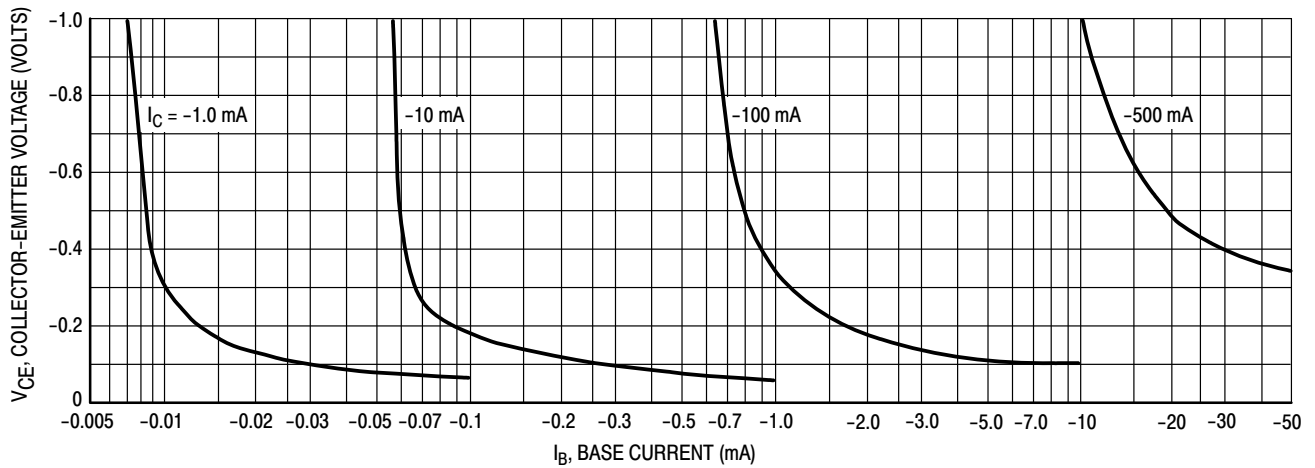

Figure 4. Collector Saturation Region

MPS2907A Series

ORDERING INFORMATION

Device	Package	Shipping†
MPS2907AG	TO-92 (Pb-Free)	5000 Units / Bulk
MPS2907ARLG	TO-92 (Pb-Free)	2000 / Tape & Reel
MPS2907ARLRAG	TO-92 (Pb-Free)	
MPS2907ARLRPG	TO-92 (Pb-Free)	2000 / Ammo Pack

†For information on tape and reel specifications, including part orientation and tape sizes, please refer to our Tape and Reel Packaging Specifications Brochure, BRD8011/D.

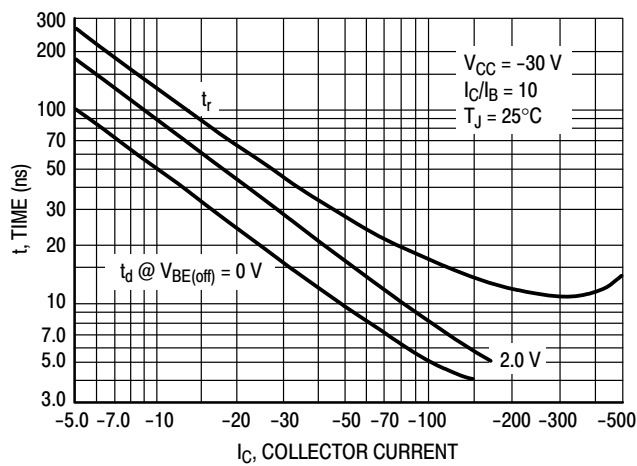

Figure 5. Turn-On Time

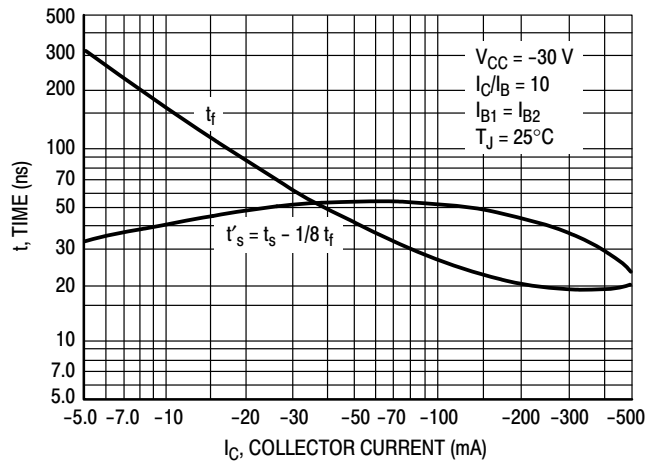

Figure 6. Turn-Off Time

MPS2907A Series

TYPICAL SMALL-SIGNAL CHARACTERISTICS NOISE FIGURE

$V_{CE} = 10 \text{ Vdc}$, $T_A = 25^\circ\text{C}$

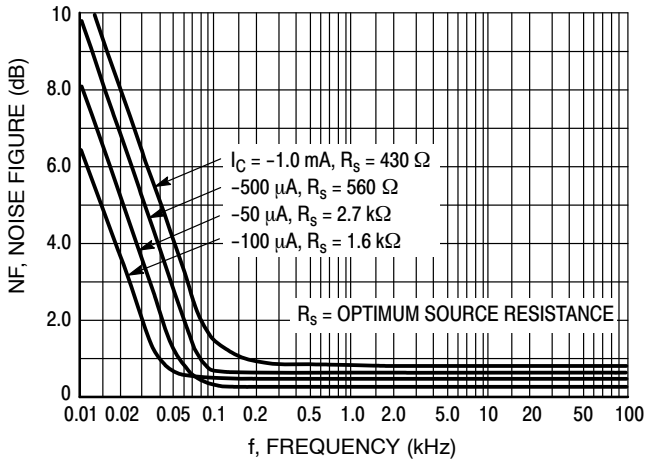

Figure 7. Frequency Effects

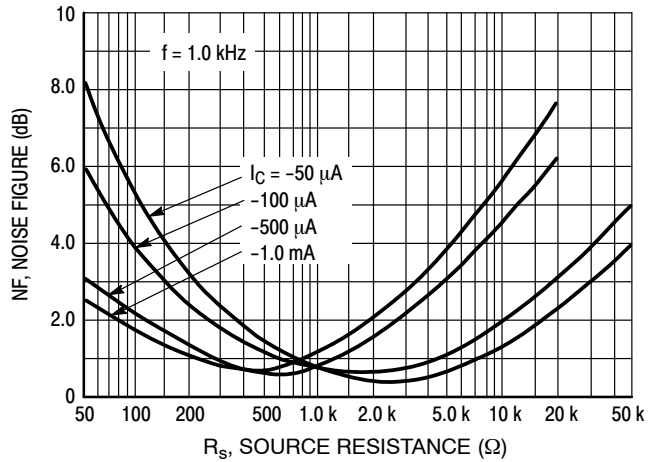

Figure 8. Source Resistance Effects

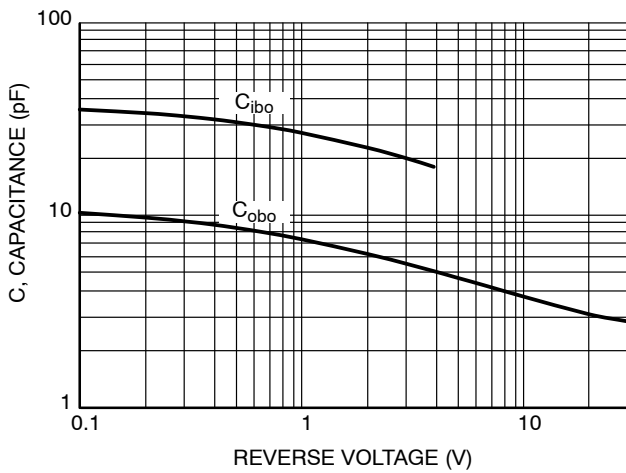

Figure 9. Capacitances

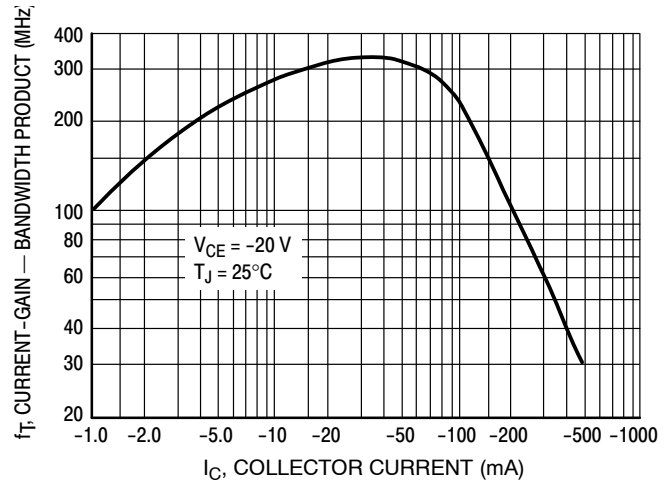

Figure 10. Current-Gain - Bandwidth Product

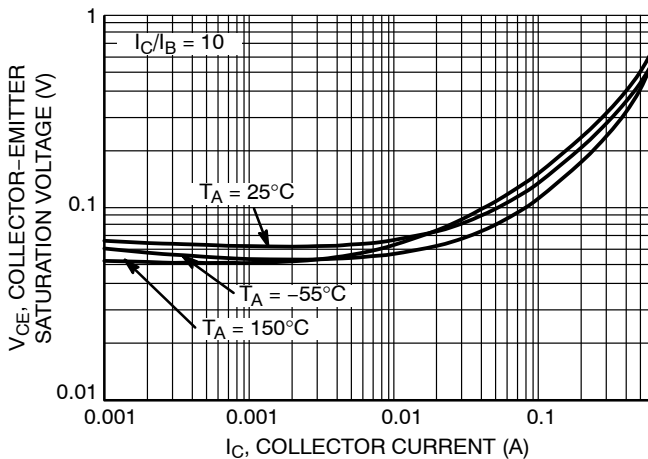

Figure 11. Collector-Emitter Saturation Voltage vs. Collector Current

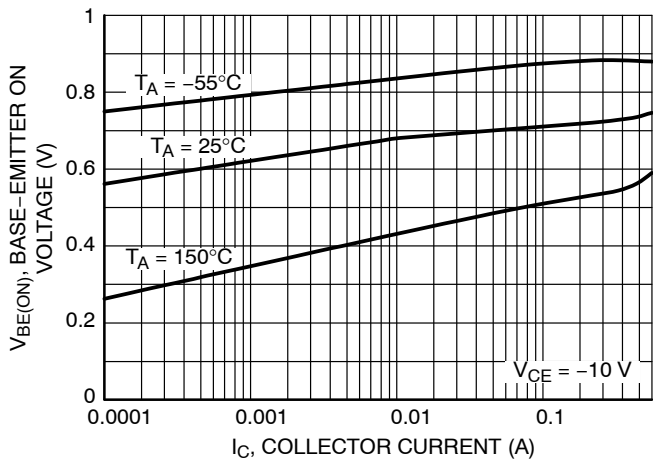

Figure 12. Base-Emitter Turn-ON Voltage vs. Collector Current

MPS2907A Series

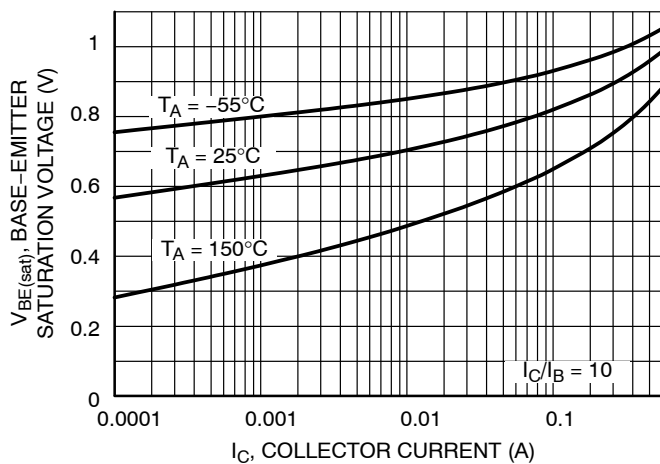

Figure 13. Base Emitter Saturation Voltage vs. Collector Current

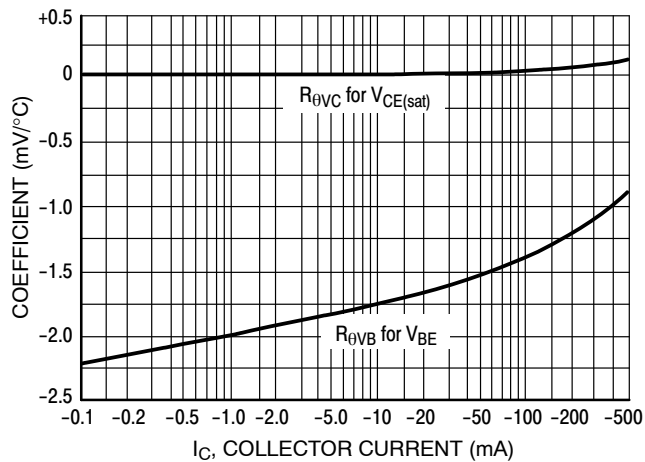

Figure 14. Temperature Coefficients

MECHANICAL CASE OUTLINE PACKAGE DIMENSIONS

ON Semiconductor®



SCALE 1:1



TO-92 (TO-226)
CASE 29-11
ISSUE AM

DATE 09 MAR 2007



STRAIGHT LEAD
BULK PACK



NOTES:

1. DIMENSIONING AND TOLERANCING PER ANSI Y14.5M, 1982.
2. CONTROLLING DIMENSION: INCH.
3. CONTOUR OF PACKAGE BEYOND DIMENSION R IS UNCONTROLLED.
4. LEAD DIMENSION IS UNCONTROLLED IN P AND BEYOND DIMENSION K MINIMUM.

DIM	INCHES		MILLIMETERS	
	MIN	MAX	MIN	MAX
A	0.175	0.205	4.45	5.20
B	0.170	0.210	4.32	5.33
C	0.125	0.165	3.18	4.19
D	0.016	0.021	0.407	0.533
G	0.045	0.055	1.15	1.39
H	0.095	0.105	2.42	2.66
J	0.015	0.020	0.39	0.50
K	0.500	---	12.70	---
L	0.250	---	6.35	---
N	0.080	0.105	2.04	2.66
P	---	0.100	---	2.54
R	0.115	---	2.93	---
V	0.135	---	3.43	---



BENT LEAD
TAPE & REEL
AMMO PACK



NOTES:

1. DIMENSIONING AND TOLERANCING PER ASME Y14.5M, 1994.
2. CONTROLLING DIMENSION: MILLIMETERS.
3. CONTOUR OF PACKAGE BEYOND DIMENSION R IS UNCONTROLLED.
4. LEAD DIMENSION IS UNCONTROLLED IN P AND BEYOND DIMENSION K MINIMUM.

DIM	MILLIMETERS	
	MIN	MAX
A	4.45	5.20
B	4.32	5.33
C	3.18	4.19
D	0.40	0.54
G	2.40	2.80
J	0.39	0.50
K	12.70	---
N	2.04	2.66
P	1.50	4.00
R	2.93	---
V	3.43	---

STYLES ON PAGE 2

DOCUMENT NUMBER:	98ASB42022B	Electronic versions are uncontrolled except when accessed directly from the Document Repository. Printed versions are uncontrolled except when stamped "CONTROLLED COPY" in red.
STATUS:	ON SEMICONDUCTOR STANDARD	
NEW STANDARD:		
DESCRIPTION:	TO-92 (TO-226)	PAGE 1 OF 3

TO-92 (TO-226)
CASE 29-11
ISSUE AM

DATE 09 MAR 2007

STYLE 1:
 PIN 1. EMITTER
 2. BASE
 3. COLLECTOR

STYLE 2:
 PIN 1. BASE
 2. EMITTER
 3. COLLECTOR

STYLE 3:
 PIN 1. ANODE
 2. ANODE
 3. CATHODE

STYLE 4:
 PIN 1. CATHODE
 2. CATHODE
 3. ANODE

STYLE 5:
 PIN 1. DRAIN
 2. SOURCE
 3. GATE

STYLE 6:
 PIN 1. GATE
 2. SOURCE & SUBSTRATE
 3. DRAIN

STYLE 7:
 PIN 1. SOURCE
 2. DRAIN
 3. GATE

STYLE 8:
 PIN 1. DRAIN
 2. GATE
 3. SOURCE & SUBSTRATE

STYLE 9:
 PIN 1. BASE 1
 2. EMITTER
 3. BASE 2

STYLE 10:
 PIN 1. CATHODE
 2. GATE
 3. ANODE

STYLE 11:
 PIN 1. ANODE
 2. CATHODE & ANODE
 3. CATHODE

STYLE 12:
 PIN 1. MAIN TERMINAL 1
 2. GATE
 3. MAIN TERMINAL 2

STYLE 13:
 PIN 1. ANODE 1
 2. GATE
 3. CATHODE 2

STYLE 14:
 PIN 1. EMITTER
 2. COLLECTOR
 3. BASE

STYLE 15:
 PIN 1. ANODE 1
 2. CATHODE
 3. ANODE 2

STYLE 16:
 PIN 1. ANODE
 2. GATE
 3. CATHODE

STYLE 17:
 PIN 1. COLLECTOR
 2. BASE
 3. EMITTER

STYLE 18:
 PIN 1. ANODE
 2. CATHODE
 3. NOT CONNECTED

STYLE 19:
 PIN 1. GATE
 2. ANODE
 3. CATHODE

STYLE 20:
 PIN 1. NOT CONNECTED
 2. CATHODE
 3. ANODE

STYLE 21:
 PIN 1. COLLECTOR
 2. EMITTER
 3. BASE

STYLE 22:
 PIN 1. SOURCE
 2. GATE
 3. DRAIN

STYLE 23:
 PIN 1. GATE
 2. SOURCE
 3. DRAIN

STYLE 24:
 PIN 1. EMITTER
 2. COLLECTOR/ANODE
 3. CATHODE

STYLE 25:
 PIN 1. MT 1
 2. GATE
 3. MT 2

STYLE 26:
 PIN 1. V_{CC}
 2. GROUND 2
 3. OUTPUT

STYLE 27:
 PIN 1. MT
 2. SUBSTRATE
 3. MT

STYLE 28:
 PIN 1. CATHODE
 2. ANODE
 3. GATE

STYLE 29:
 PIN 1. NOT CONNECTED
 2. ANODE
 3. CATHODE

STYLE 30:
 PIN 1. DRAIN
 2. GATE
 3. SOURCE

STYLE 31:
 PIN 1. GATE
 2. DRAIN
 3. SOURCE

STYLE 32:
 PIN 1. BASE
 2. COLLECTOR
 3. EMITTER

STYLE 33:
 PIN 1. RETURN
 2. INPUT
 3. OUTPUT

STYLE 34:
 PIN 1. INPUT
 2. GROUND
 3. LOGIC

STYLE 35:
 PIN 1. GATE
 2. COLLECTOR
 3. EMITTER

DOCUMENT NUMBER:	98ASB42022B	Electronic versions are uncontrolled except when accessed directly from the Document Repository. Printed versions are uncontrolled except when stamped "CONTROLLED COPY" in red.
STATUS:	ON SEMICONDUCTOR STANDARD	
NEW STANDARD:		
DESCRIPTION:	TO-92 (TO-226)	PAGE 2 OF 3

ON Semiconductor®



DOCUMENT NUMBER:
98ASB42022B

PAGE 3 OF 3

ISSUE	REVISION	DATE
AM	ADDED BENT-LEAD TAPE & REEL VERSION. REQ. BY J. SUPINA.	09 MAR 2007

ON Semiconductor and  are registered trademarks of Semiconductor Components Industries, LLC (SCILLC). SCILLC reserves the right to make changes without further notice to any products herein. SCILLC makes no warranty, representation or guarantee regarding the suitability of its products for any particular purpose, nor does SCILLC assume any liability arising out of the application or use of any product or circuit, and specifically disclaims any and all liability, including without limitation special, consequential or incidental damages. "Typical" parameters which may be provided in SCILLC data sheets and/or specifications can and do vary in different applications and actual performance may vary over time. All operating parameters, including "Typicals" must be validated for each customer application by customer's technical experts. SCILLC does not convey any license under its patent rights nor the rights of others. SCILLC products are not designed, intended, or authorized for use as components in systems intended for surgical implant into the body, or other applications intended to support or sustain life, or for any other application in which the failure of the SCILLC product could create a situation where personal injury or death may occur. Should Buyer purchase or use SCILLC products for any such unintended or unauthorized application, Buyer shall indemnify and hold SCILLC and its officers, employees, subsidiaries, affiliates, and distributors harmless against all claims, costs, damages, and expenses, and reasonable attorney fees arising out of, directly or indirectly, any claim of personal injury or death associated with such unintended or unauthorized use, even if such claim alleges that SCILLC was negligent regarding the design or manufacture of the part. SCILLC is an Equal Opportunity/Affirmative Action Employer. This literature is subject to all applicable copyright laws and is not for resale in any manner.

onsemi, **Onsemi**, and other names, marks, and brands are registered and/or common law trademarks of Semiconductor Components Industries, LLC dba "**onsemi**" or its affiliates and/or subsidiaries in the United States and/or other countries. **onsemi** owns the rights to a number of patents, trademarks, copyrights, trade secrets, and other intellectual property. A listing of **onsemi**'s product/patent coverage may be accessed at www.onsemi.com/site/pdf/Patent-Marking.pdf. **onsemi** reserves the right to make changes at any time to any products or information herein, without notice. The information herein is provided "as-is" and **onsemi** makes no warranty, representation or guarantee regarding the accuracy of the information, product features, availability, functionality, or suitability of its products for any particular purpose, nor does **onsemi** assume any liability arising out of the application or use of any product or circuit, and specifically disclaims any and all liability, including without limitation special, consequential or incidental damages. Buyer is responsible for its products and applications using **onsemi** products, including compliance with all laws, regulations and safety requirements or standards, regardless of any support or applications information provided by **onsemi**. "Typical" parameters which may be provided in **onsemi** data sheets and/or specifications can and do vary in different applications and actual performance may vary over time. All operating parameters, including "Typicals" must be validated for each customer application by customer's technical experts. **onsemi** does not convey any license under any of its intellectual property rights nor the rights of others. **onsemi** products are not designed, intended, or authorized for use as a critical component in life support systems or any FDA Class 3 medical devices or medical devices with a same or similar classification in a foreign jurisdiction or any devices intended for implantation in the human body. Should Buyer purchase or use **onsemi** products for any such unintended or unauthorized application, Buyer shall indemnify and hold **onsemi** and its officers, employees, subsidiaries, affiliates, and distributors harmless against all claims, costs, damages, and expenses, and reasonable attorney fees arising out of, directly or indirectly, any claim of personal injury or death associated with such unintended or unauthorized use, even if such claim alleges that **onsemi** was negligent regarding the design or manufacture of the part. **onsemi** is an Equal Opportunity/Affirmative Action Employer. This literature is subject to all applicable copyright laws and is not for resale in any manner.

PUBLICATION ORDERING INFORMATION

LITERATURE FULFILLMENT:

Email Requests to: orderlit@onsemi.com

onsemi Website: www.onsemi.com

TECHNICAL SUPPORT

North American Technical Support:

Voice Mail: 1 800-282-9855 Toll Free USA/Canada

Phone: 011 421 33 790 2910

Europe, Middle East and Africa Technical Support:

Phone: 00421 33 790 2910

For additional information, please contact your local Sales Representative