

# MOC8021M, MOC8050M

## 6-Pin DIP Photodarlington Optocoupler (No Base Connection)

The MOC8021M and MOC8050M are photodarlington-type optically coupled optocouplers. The devices have a gallium arsenide infrared emitting diode coupled with a silicon darlington phototransistor.

### Features

- High  $BV_{CEO}$ :
  - ◆ Minimum 50 V (MOC8021M)
  - ◆ Minimum 80 V (MOC8050M)
- High Current Transfer Ratio:
  - ◆ Minimum 1000% (MOC8021M)
  - ◆ Minimum 500% (MOC8050M)
- No Base Connection for Improved Noise Immunity
- Safety and Regulatory Approvals:
  - ◆ UL1577, 4,170 VAC<sub>RMS</sub> for 1 Minute
  - ◆ DIN-EN/IEC60747-5-5, 850 V Peak Working Insulation Voltage

### Applications

- Appliances, Measuring Instruments
- I/O Interface for Computers
- Programmable Controllers
- Portable Electronics
- Interfacing and Coupling Systems of Different Potentials and Impedance
- Solid State Relays

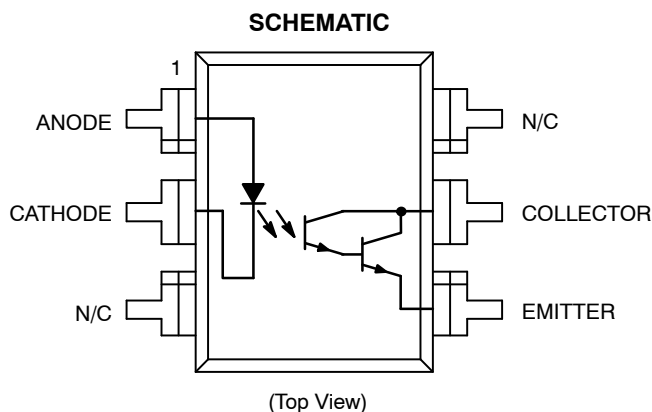

**ON Semiconductor®**

[www.onsemi.com](http://www.onsemi.com)

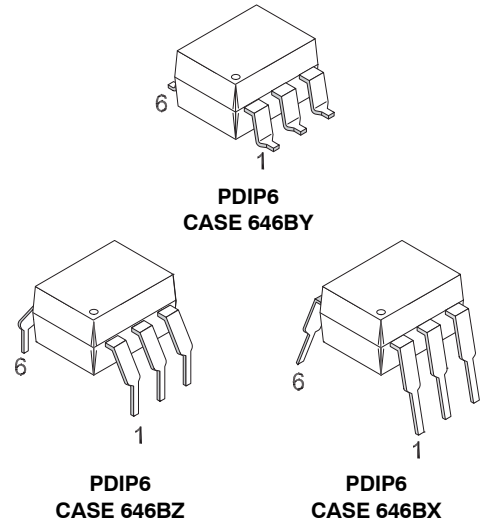

### MARKING DIAGRAM

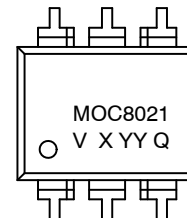

MOC8021 = Device Code  
V = DIN EN/IEC60747-5-5 Option  
(only appears on component ordered with this option)  
X = One-Digit Year Code, e.g., "5"  
YY = Digit Work Week, Ranging from "01" to "53"  
Q = Assembly Package Code

### ORDERING INFORMATION

See detailed ordering, marking and shipping information on page 7 of this data sheet.

# MOC8021M, MOC8050M

**Table 1. SAFETY AND INSULATION RATINGS**

As per DIN EN/IEC 60747-5-5, this optocoupler is suitable for “safe electrical insulation” only within the safety limit data. Compliance with the safety ratings shall be ensured by means of protective circuits.

Parameter		Characteristics
Installation Classifications per DIN VDE 0110/1.89 Table 1, For Rated Mains Voltage	< 150 V <sub>RMS</sub>	I-IV
	< 300 V <sub>RMS</sub>	I-IV
Climatic Classification		55/100/21
Pollution Degree (DIN VDE 0110/1.89)		2
Comparative Tracking Index		175

Symbol	Parameter	Value	Unit
V <sub>PR</sub>	Input-to-Output Test Voltage, Method A, V <sub>IORM</sub> × 1.6 = V <sub>PR</sub> , Type and Sample Test with t <sub>m</sub> = 10 s, Partial Discharge < 5 pC	1360	V <sub>peak</sub>
	Input-to-Output Test Voltage, Method B, V <sub>IORM</sub> × 1.875 = V <sub>PR</sub> , 100% Production Test with t <sub>m</sub> = 1 s, Partial Discharge < 5 pC	1594	V <sub>peak</sub>
V <sub>IORM</sub>	Maximum Working Insulation Voltage	850	V <sub>peak</sub>
V <sub>IOTM</sub>	Highest Allowable Over-Voltage	6,000	V <sub>peak</sub>
	External Creepage	≥ 7	mm
	External Clearance	≥ 7	mm
	External Clearance (for Option TV, 0.4" Lead Spacing)	≥ 10	mm
DTI	Distance Through Insulation (Insulation Thickness)	≥ 0.5	mm
T <sub>S</sub>	Case Temperature (Note 1)	175	°C
I <sub>S,INPUT</sub>	Input Current (Note 1)	350	mA
P <sub>S,OUTPUT</sub>	Output Power (Note 1)	800	mW
R <sub>IO</sub>	Insulation Resistance at T <sub>S</sub> , V <sub>IO</sub> = 500 V (Note 1)	> 10 <sup>9</sup>	Ω

1. Safety limit values – maximum values allowed in the event of a failure.

**Table 2. ABSOLUTE MAXIMUM RATINGS**

Symbol	Parameter	Value	Units
<b>TOTAL DEVICE</b>			
T <sub>STG</sub>	Storage Temperature	-40 to +125	°C
T <sub>OPR</sub>	Operating Temperature	-40 to +100	°C
T <sub>J</sub>	Junction Temperature	-40 to +125	°C
T <sub>SOL</sub>	Lead Solder Temperature	260 for 10 seconds	°C
P <sub>D</sub>	Total Device Power Dissipation @ T <sub>A</sub> = 25°C	270	mW
	Derate above 25°C	2.94	mW/°C
<b>EMITTER</b>			
I <sub>F</sub>	DC/Average Forward Input Current	60	mA
V <sub>R</sub>	Reverse Input Voltage	3	V
P <sub>D</sub>	LED Power Dissipation @ T <sub>A</sub> = 25°C	120	mW
	Derate Above 25°C	1.41	mW/°C
<b>DETECTOR</b>			
I <sub>C</sub>	Continuous Collector Current	150	mA
V <sub>CEO</sub>	Collector-Emitter Voltage – MOC8021M	50	V
	Collector-Emitter Voltage – MOC8050M	80	V
P <sub>D</sub>	Detector Power Dissipation @ T <sub>A</sub> = 25°C	150	mW
	Derate Above 25°C	1.76	mW/°C

Stresses exceeding those listed in the Maximum Ratings table may damage the device. If any of these limits are exceeded, device functionality should not be assumed, damage may occur and reliability may be affected.

## MOC8021M, MOC8050M

**Table 3. ELECTRICAL CHARACTERISTICS**  $T_A = 25^\circ\text{C}$  unless otherwise specified

Symbol	Parameter	Test Conditions	Min	Typ	Max	Units
<b>EMITTER</b>						
$V_F$	Input Forward Voltage	$I_F = 10\text{ mA}$		1.18	2.00	V
$I_R$	Reverse Leakage Current	$V_R = 3.0\text{ V}$		0.001	10	$\mu\text{A}$
<b>DETECTOR</b>						
$BV_{CEO}$	Collector–Emitter Breakdown Voltage (MOC8021M)	$I_C = 1.0\text{ mA}, I_F = 0$	50	100		V
	(MOC8050M)		80	100		V
$BV_{ECO}$	Emitter–Collector Breakdown Voltage	$I_E = 100\text{ }\mu\text{A}, I_F = 0$	5	10		V
$I_{CEO}$	Collector–Emitter Dark Current	$V_{CE} = 60\text{ V}, I_F = 0$			1	$\mu\text{A}$
$C_{CE}$	Capacitance	$V_{CE} = 0\text{ V}, f = 1\text{ MHz}$		8		pF

**Table 4. TRANSFER CHARACTERISTICS**  $T_A = 25^\circ\text{C}$  unless otherwise specified

Symbol	Parameter	Test Conditions	Min	Typ	Max	Units
<b>DC CHARACTERISTICS</b>						
CTR	Current Transfer Ratio, Collector–to–Emitter (MOC8021M)	$I_F = 10\text{ mA}, V_{CE} = 5\text{ V}$	1,000			%
	(MOC8050M)	$I_F = 10\text{ mA}, V_{CE} = 1.5\text{ V}$	500			%

### AC CHARACTERISTICS

$t_{on}$	Turn–on Time	$I_F = 5\text{ mA}, V_{CC} = 10\text{ V}, R_L = 100\text{ }\Omega$		8.5		$\mu\text{s}$
$t_{off}$	Turn–off Time	$I_F = 5\text{ mA}, V_{CC} = 10\text{ V}, R_L = 100\text{ }\Omega$		95		$\mu\text{s}$

**Table 5. ISOLATION CHARACTERISTICS**

Symbol	Parameter	Test Conditions	Min	Typ	Max	Units
$V_{ISO}$	Input–Output Isolation Voltage	$t = 1\text{ Minute}$	4170			$V_{AC_{RMS}}$
$C_{ISO}$	Isolation Capacitance	$V_{I-O} = 0\text{ V}, f = 1\text{ MHz}$		0.2		pF
$R_{ISO}$	Isolation Resistance	$V_{I-O} = \pm 500\text{ VDC}, T_A = 25^\circ\text{C}$	$10^{11}$			$\Omega$

Product parametric performance is indicated in the Electrical Characteristics for the listed test conditions, unless otherwise noted. Product performance may not be indicated by the Electrical Characteristics if operated under different conditions.

# MOC8021M, MOC8050M

## TYPICAL CHARACTERISTICS

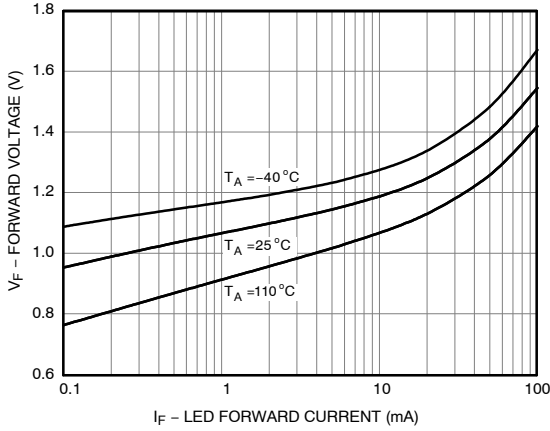

**Figure 1. LED Forward Voltage vs. Forward Current**

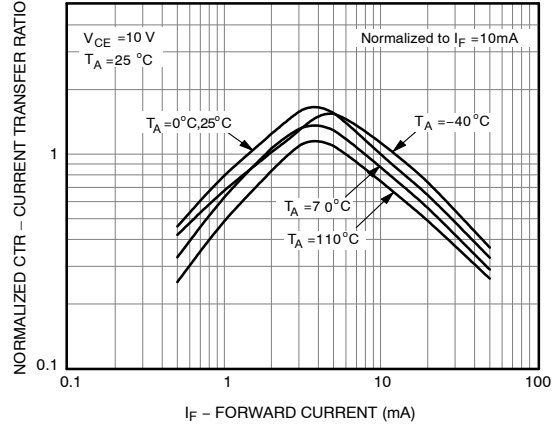

**Figure 2. Normalized CTR vs. Forward Current**

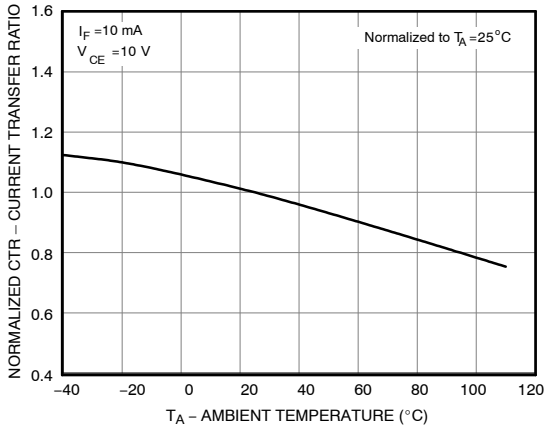

**Figure 3. Normalized CTR vs. Ambient Temperature**

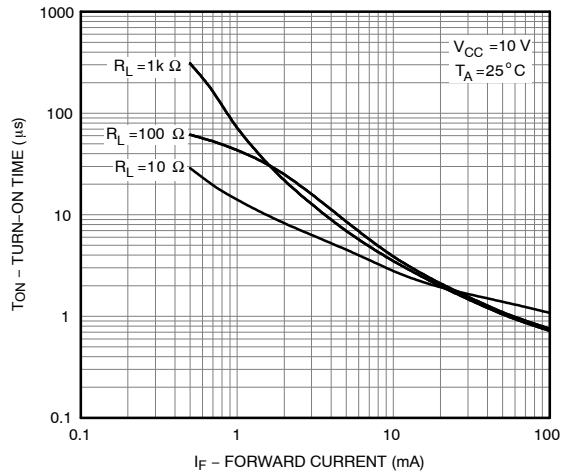

**Figure 4. Turn-on Time vs. Forward Current**

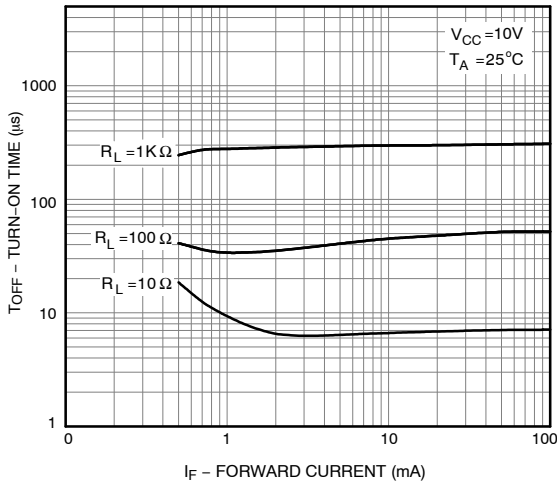

**Figure 5. Turn-off Time vs. Forward Current**

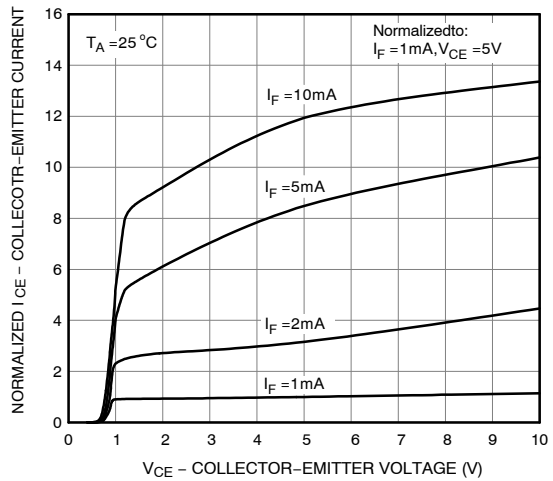

**Figure 6. Normalized Collector-Emitter Current vs. Collector-Emitter Voltage**

Typical Performance Curves (Continued)

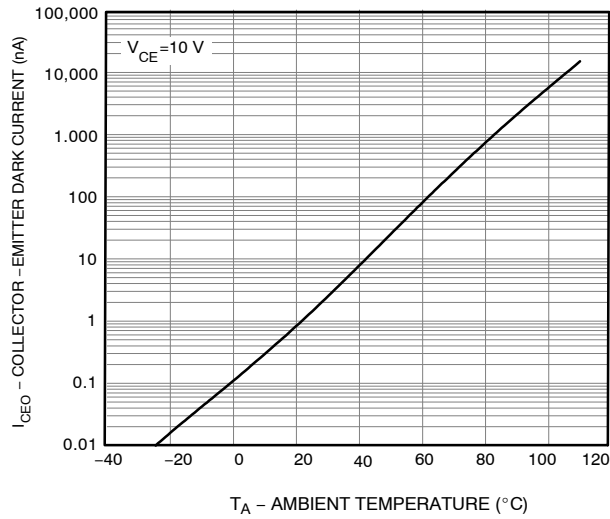

Figure 7. Dark Current vs. Ambient Temperature

Switching Time Test Circuit and Waveform

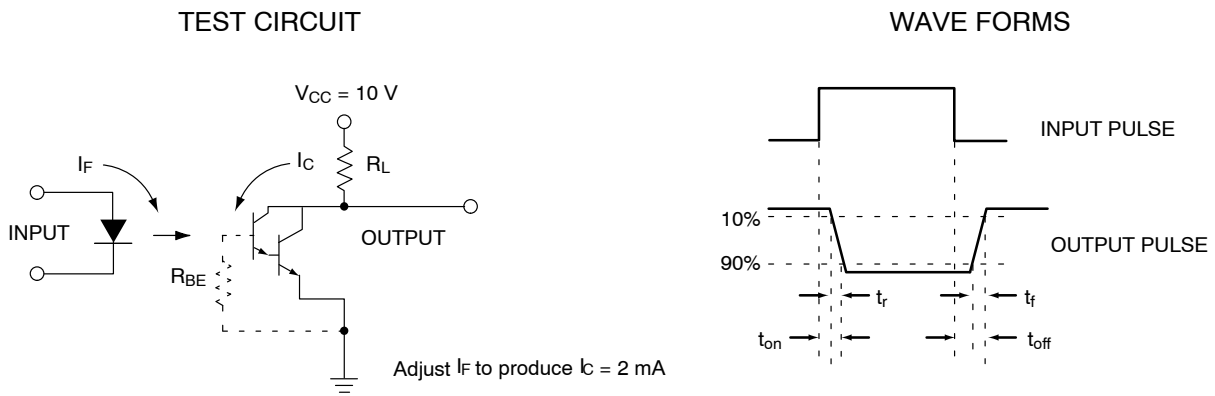

Figure 8. Switching Time Test Circuit and Waveform

# MOC8021M, MOC8050M

## REFLOW PROFILE

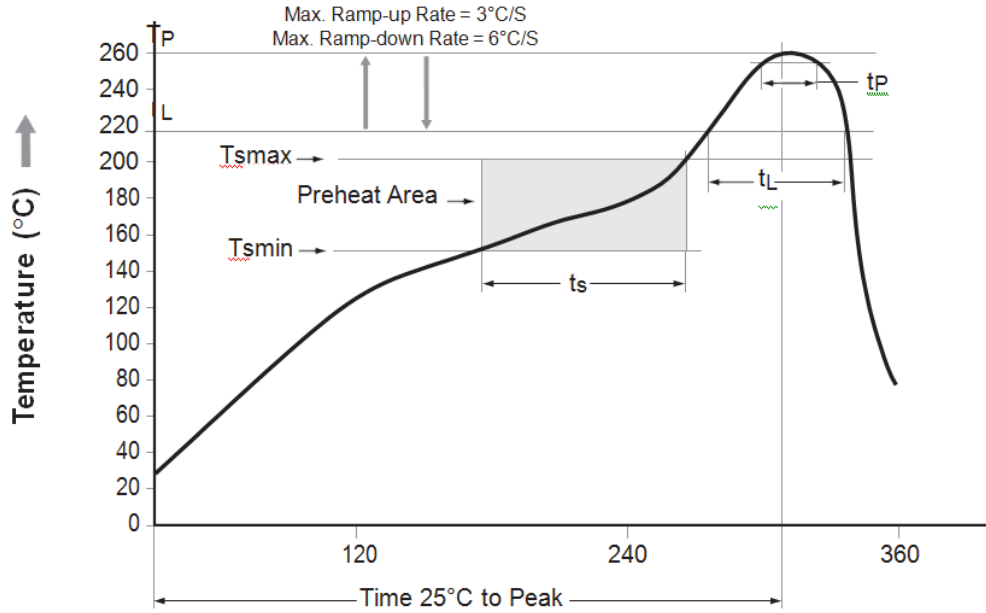

Figure 9. Reflow Profile

Profile Feature	Pb – Free Assembly Profile
Temperature Min. ( $T_{smin}$ )	150°C
Temperature Max. ( $T_{smax}$ )	200°C
Time ( $t_s$ ) from ( $T_{smin}$ to $T_{smax}$ )	60–120 seconds
Ramp – up Rate ( $t$ to $t_p$ )	3°C/second max.
Liquidous Temperature ( $T_L$ )	217°C
Time ( $t_L$ ) Maintained Above ( $T_L$ )	60–150 seconds
Peak Body Package Temperature	260°C +0°C / –5°C
Time ( $t_P$ ) within 5°C of 260°C	30 seconds
Ramp – down Rate ( $T_P$ to $T_L$ )	6°C / second max.
Time 25°C to Peak Temperature	8 minutes max.

## MOC8021M, MOC8050M

### ORDERING INFORMATION

Part Number	Package	Packing Method
MOC8021M	DIP 6-Pin	Tube (50 Units)
MOC8021SM	SMT 6-Pin (Lead Bend)	Tube (50 Units)
MOC8021SR2M	SMT 6-Pin (Lead Bend)	Tape and Reel (1000 Units)
MOC8021VM	DIP 6-Pin, DIN EN/IEC60747-5-5 Option	Tube (50 Units)
MOC8021SVM	SMT 6-Pin (Lead Bend), DIN EN/IEC60747-5-5 Option	Tube (50 Units)
MOC8021SR2VM	SMT 6-Pin (Lead Bend), DIN EN/IEC60747-5-5 Option	Tape and Reel (1000 Units)
MOC8021TVM	DIP 6-Pin, 0.4" Lead Spacing, DIN EN/IEC60747-5-5 Option	Tube (50 Units)
MOC8050M	DIP 6-Pin	Tube (50 Units)
MOC8050SM	SMT 6-Pin (Lead Bend)	Tube (50 Units)
MOC8050SR2M	SMT 6-Pin (Lead Bend)	Tape and Reel (1000 Units)
MOC8050VM	DIP 6-Pin, DIN EN/IEC60747-5-5 Option	Tube (50 Units)
MOC8050SVM	SMT 6-Pin (Lead Bend), DIN EN/IEC60747-5-5 Option	Tube (50 Units)
MOC8050SR2VM	SMT 6-Pin (Lead Bend), DIN EN/IEC60747-5-5 Option	Tape and Reel (1000 Units)
MOC8050TVM	DIP 6-Pin, 0.4" Lead Spacing, DIN EN/IEC60747-5-5 Option	Tube (50 Units)

# MOC8021M, MOC8050M

## PACKAGE DIMENSIONS

PDIP6 8.51x6.35, 2.54P  
CASE 646BX  
ISSUE O

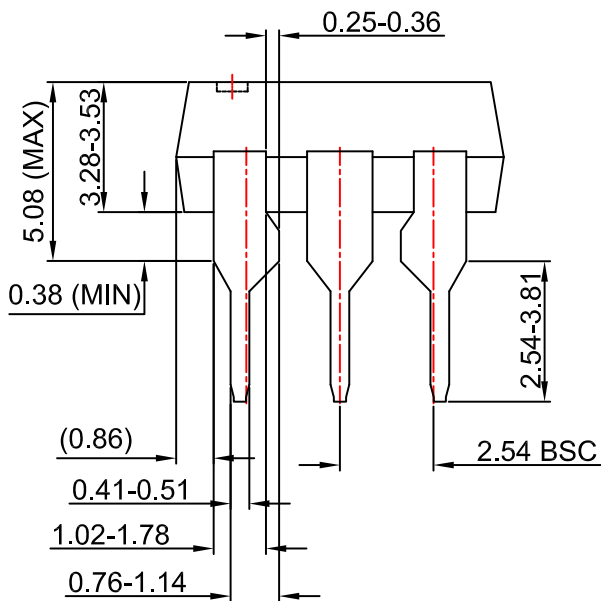
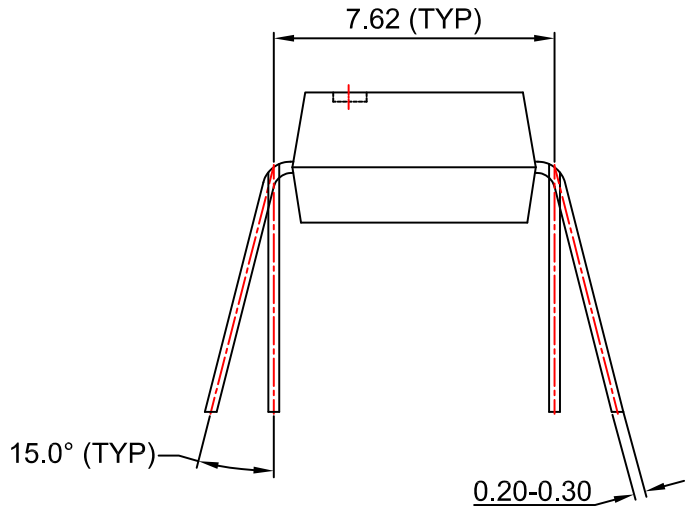
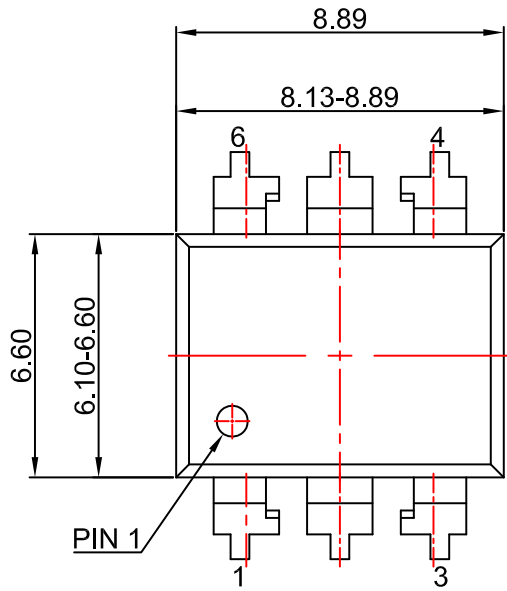

### NOTES:

- A) NO STANDARD APPLIES TO THIS PACKAGE.
- B) ALL DIMENSIONS ARE IN MILLIMETERS.
- C) DIMENSIONS ARE EXCLUSIVE OF BURRS, MOLD FLASH, AND TIE BAR EXTRUSION



# MOC8021M, MOC8050M

## PACKAGE DIMENSIONS

PDIP6 8.51x6.35, 2.54P  
CASE 646BY  
ISSUE 0

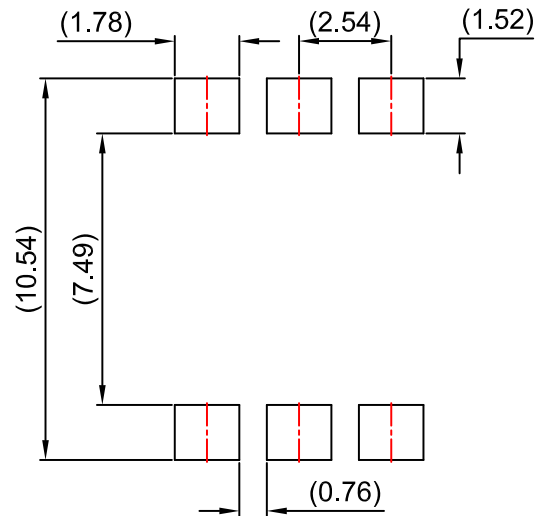
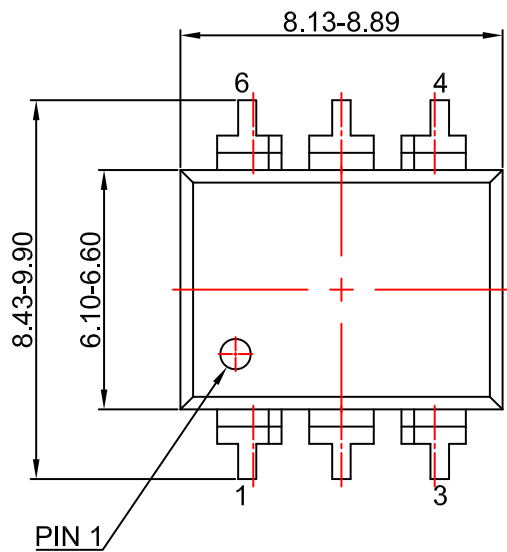

LAND PATTERN RECOMMENDATION

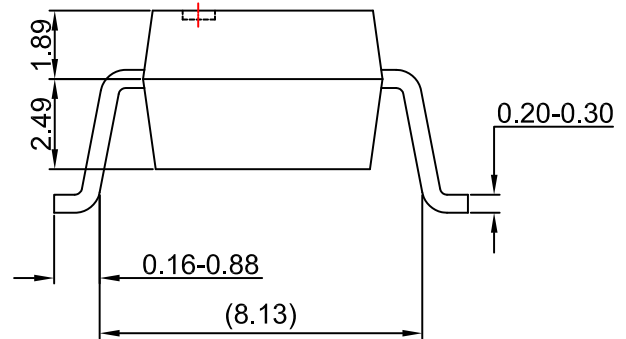
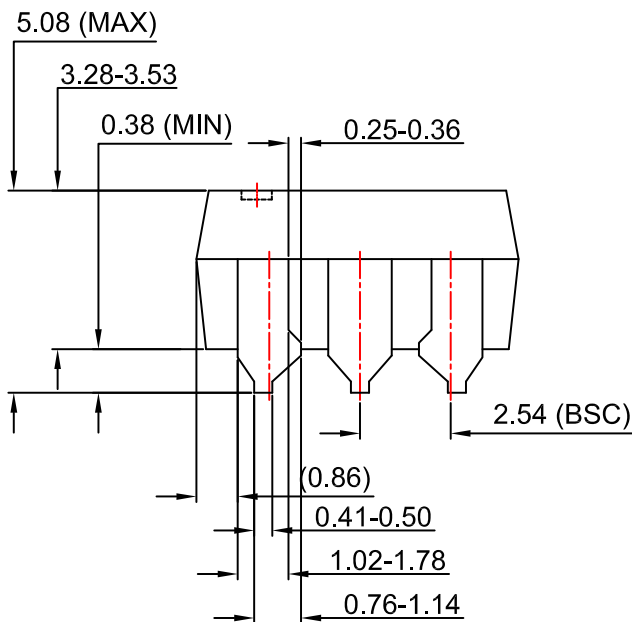

### NOTES:

- A) NO STANDARD APPLIES TO THIS PACKAGE.
- B) ALL DIMENSIONS ARE IN MILLIMETERS.
- C) DIMENSIONS ARE EXCLUSIVE OF BURRS, MOLD FLASH, AND TIE BAR EXTRUSION

# MOC8021M, MOC8050M

## PACKAGE DIMENSIONS

PDIP6 8.51x6.35, 2.54P  
CASE 646BZ  
ISSUE O

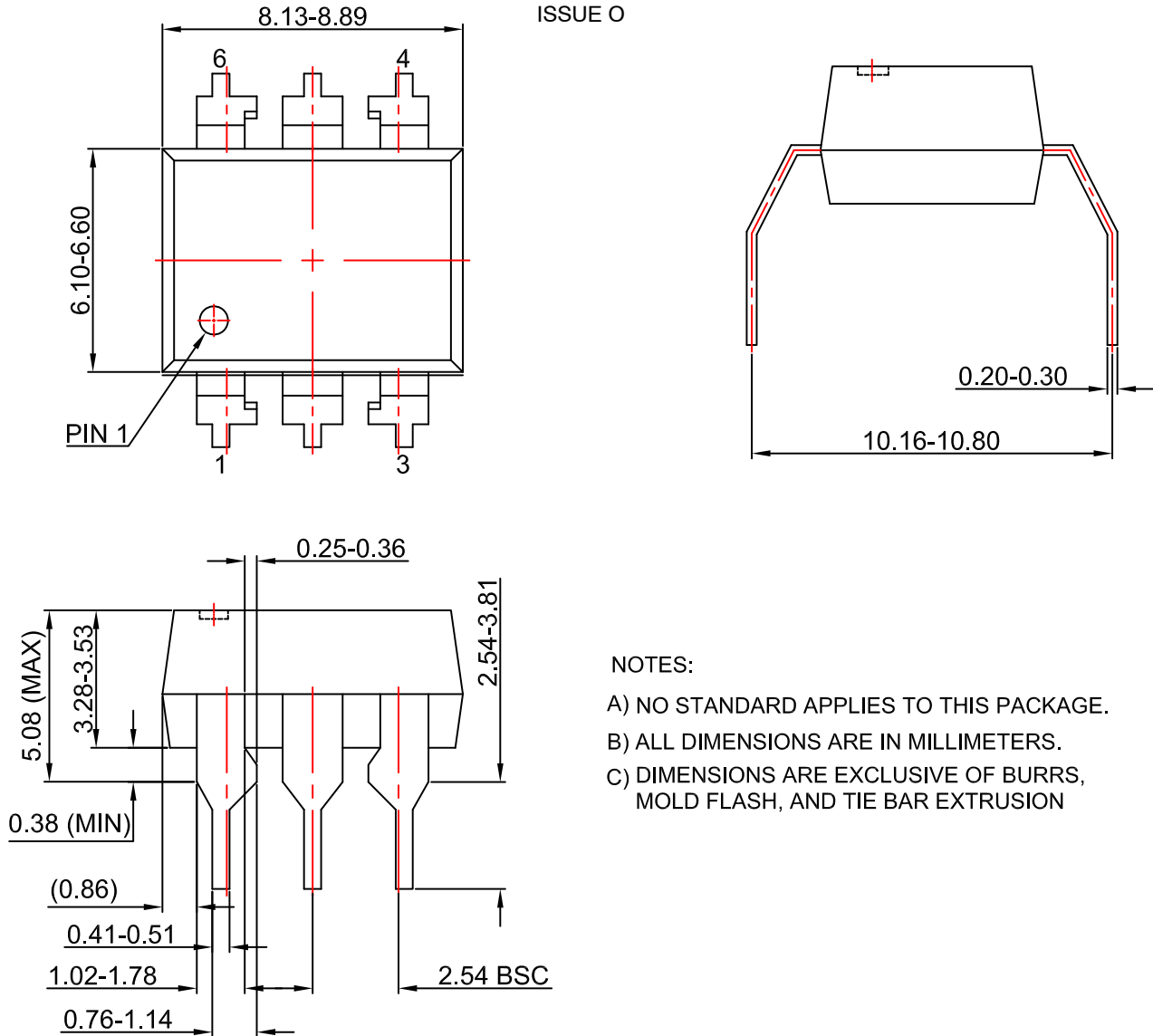

### NOTES:

- A) NO STANDARD APPLIES TO THIS PACKAGE.
- B) ALL DIMENSIONS ARE IN MILLIMETERS.
- C) DIMENSIONS ARE EXCLUSIVE OF BURRS, MOLD FLASH, AND TIE BAR EXTRUSION

ON Semiconductor and  are trademarks of Semiconductor Components Industries, LLC dba ON Semiconductor or its subsidiaries in the United States and/or other countries. ON Semiconductor owns the rights to a number of patents, trademarks, copyrights, trade secrets, and other intellectual property. A listing of ON Semiconductor's product/patent coverage may be accessed at [www.onsemi.com/site/pdf/Patent-Marketing.pdf](http://www.onsemi.com/site/pdf/Patent-Marketing.pdf). ON Semiconductor reserves the right to make changes without further notice to any products herein. ON Semiconductor makes no warranty, representation or guarantee regarding the suitability of its products for any particular purpose, nor does ON Semiconductor assume any liability arising out of the application or use of any product or circuit, and specifically disclaims any and all liability, including without limitation special, consequential or incidental damages. Buyer is responsible for its products and applications using ON Semiconductor products, including compliance with all laws, regulations and safety requirements or standards, regardless of any support or applications information provided by ON Semiconductor. "Typical" parameters which may be provided in ON Semiconductor data sheets and/or specifications can and do vary in different applications and actual performance may vary over time. All operating parameters, including "Typicals" must be validated for each customer application by customer's technical experts. ON Semiconductor does not convey any license under its patent rights nor the rights of others. ON Semiconductor products are not designed, intended, or authorized for use as a critical component in life support systems or any FDA Class 3 medical devices or medical devices with a same or similar classification in a foreign jurisdiction or any devices intended for implantation in the human body. Should Buyer purchase or use ON Semiconductor products for any such unintended or unauthorized application, Buyer shall indemnify and hold ON Semiconductor and its officers, employees, subsidiaries, affiliates, and distributors harmless against all claims, costs, damages, and expenses, and reasonable attorney fees arising out of, directly or indirectly, any claim of personal injury or death associated with such unintended or unauthorized use, even if such claim alleges that ON Semiconductor was negligent regarding the design or manufacture of the part. ON Semiconductor is an Equal Opportunity/Affirmative Action Employer. This literature is subject to all applicable copyright laws and is not for resale in any manner.

### PUBLICATION ORDERING INFORMATION

#### LITERATURE FULFILLMENT:

Literature Distribution Center for ON Semiconductor  
19521 E. 32nd Pkwy, Aurora, Colorado 80011 USA  
Phone: 303-675-2175 or 800-344-3860 Toll Free USA/Canada  
Fax: 303-675-2176 or 800-344-3867 Toll Free USA/Canada  
Email: [orderlit@onsemi.com](mailto:orderlit@onsemi.com)

**N. American Technical Support:** 800-282-9855 Toll Free  
USA/Canada  
**Europe, Middle East and Africa Technical Support:**  
Phone: 421 33 790 2910

**ON Semiconductor Website:** [www.onsemi.com](http://www.onsemi.com)

**Order Literature:** <http://www.onsemi.com/orderlit>

For additional information, please contact your local Sales Representative