



Is Now Part of



ON Semiconductor®

To learn more about ON Semiconductor, please visit our website at
www.onsemi.com

Please note: As part of the Fairchild Semiconductor integration, some of the Fairchild orderable part numbers will need to change in order to meet ON Semiconductor's system requirements. Since the ON Semiconductor product management systems do not have the ability to manage part nomenclature that utilizes an underscore (_), the underscore (_) in the Fairchild part numbers will be changed to a dash (-). This document may contain device numbers with an underscore (_). Please check the ON Semiconductor website to verify the updated device numbers. The most current and up-to-date ordering information can be found at www.onsemi.com. Please email any questions regarding the system integration to Fairchild_questions@onsemi.com.

ON Semiconductor and the ON Semiconductor logo are trademarks of Semiconductor Components Industries, LLC dba ON Semiconductor or its subsidiaries in the United States and/or other countries. ON Semiconductor owns the rights to a number of patents, trademarks, copyrights, trade secrets, and other intellectual property. A listing of ON Semiconductor's product/patent coverage may be accessed at www.onsemi.com/site/pdf/Patent-Marking.pdf. ON Semiconductor reserves the right to make changes without further notice to any products herein. ON Semiconductor makes no warranty, representation or guarantee regarding the suitability of its products for any particular purpose, nor does ON Semiconductor assume any liability arising out of the application or use of any product or circuit, and specifically disclaims any and all liability, including without limitation special, consequential or incidental damages. Buyer is responsible for its products and applications using ON Semiconductor products, including compliance with all laws, regulations and safety requirements or standards, regardless of any support or applications information provided by ON Semiconductor. "Typical" parameters which may be provided in ON Semiconductor data sheets and/or specifications can and do vary in different applications and actual performance may vary over time. All operating parameters, including "Typicals" must be validated for each customer application by customer's technical experts. ON Semiconductor does not convey any license under its patent rights nor the rights of others. ON Semiconductor products are not designed, intended, or authorized for use as a critical component in life support systems or any FDA Class 3 medical devices or medical devices with a same or similar classification in a foreign jurisdiction or any devices intended for implantation in the human body. Should Buyer purchase or use ON Semiconductor products for any such unintended or unauthorized application, Buyer shall indemnify and hold ON Semiconductor and its officers, employees, subsidiaries, affiliates, and distributors harmless against all claims, costs, damages, and expenses, and reasonable attorney fees arising out of, directly or indirectly, any claim of personal injury or death associated with such unintended or unauthorized use, even if such claim alleges that ON Semiconductor was negligent regarding the design or manufacture of the part. ON Semiconductor is an Equal Opportunity/Affirmative Action Employer. This literature is subject to all applicable copyright laws and is not for resale in any manner.



FAN6300

Highly Integrated Quasi-Resonant Current Mode PWM Controller

Features

- High-Voltage Startup
- Quasi-Resonant Operation
- Cycle-by-Cycle Current Limiting
- Peak-Current-Mode Control
- Leading-Edge Blanking
- Internal Minimum t_{OFF}
- Internal 2ms Soft-Start
- Over-Power Compensation
- GATE Output Maximum Voltage
- Auto-Recovery Short-Circuit Protection (FB Pin)
- Auto-Recovery Open-Loop Protection (FB Pin)
- VDD Pin & Output Voltage (DET Pin) OVP Latched

Applications

- AC/DC NB Adapters
- Open-Frame SMPS

Description

The highly integrated FAN6300 PWM controller provides several features to enhance the performance of flyback converters. A built-in HV startup circuit can provide more startup current to reduce the startup time of the controller. Once the V_{DD} voltage exceeds the turn-on threshold voltage, the HV startup function is disabled immediately to improve power consumption. An internal valley voltage detector ensures the power system operates at Quasi-Resonant operation in wide-range line voltage and any load conditions and reduces switching loss to minimize switching voltage on drain of power MOSFET.

To minimize standby power consumption and light-load efficiency, a proprietary green-mode function provides off-time modulation to decrease switching frequency and perform extended valley voltage switching to keep to a minimum switching voltage.

FAN6300 controller also provides many protection functions. Pulse-by-pulse current limiting ensures the fixed peak current limit level, even when a short circuit occurs. Once an open-circuit failure occurs in the feedback loop, the internal protection circuit disables PWM output immediately. As long as V_{DD} drops below the turn-off threshold voltage, controller also disables PWM output. The gate output is clamped at 18V to protect the power MOS from high gate-source voltage conditions. The minimum t_{OFF} time limit prevents the system frequency from being too high. If the DET pin reaches OVP, internal OTP is triggered, and the power system enters latch-mode until AC power is removed.

FAN6300 controller is available in 8-pin SOP and DIP packages.

Ordering Information

Part Number	Operating Temperature Range	 Eco Status	Package	Packing Method
FAN6300SY	-40 to +105°C	Green	8-Lead, Small Out-line Package (SOP)	Tape & Reel
FAN6300DY	-40 to +105°C	Green	8-Lead, Dual In-line Package (DIP)	Tube

 For Fairchild's definition of "green" Eco Status, please visit: http://www.fairchildsemi.com/company/green/rohs_green.html.

Application Diagram

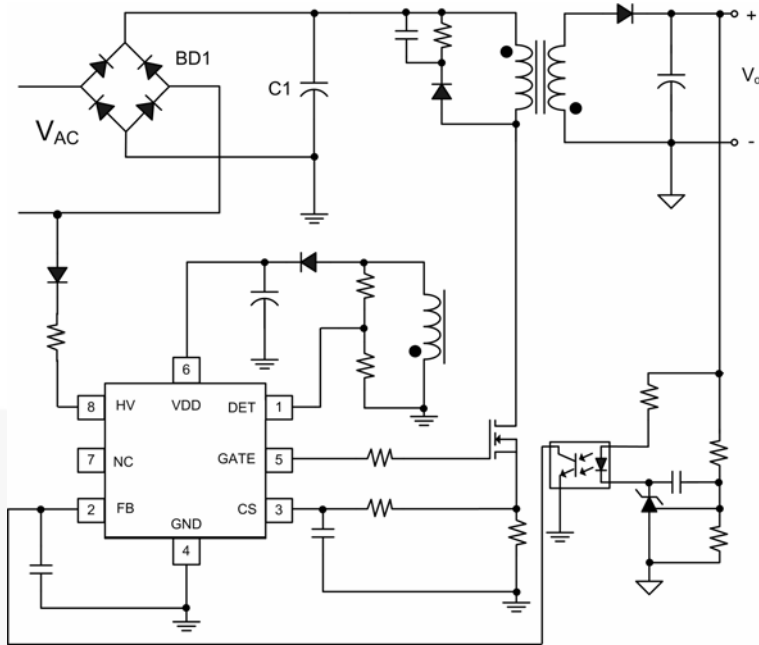

Figure 1. Typical Application

Internal Block Diagram

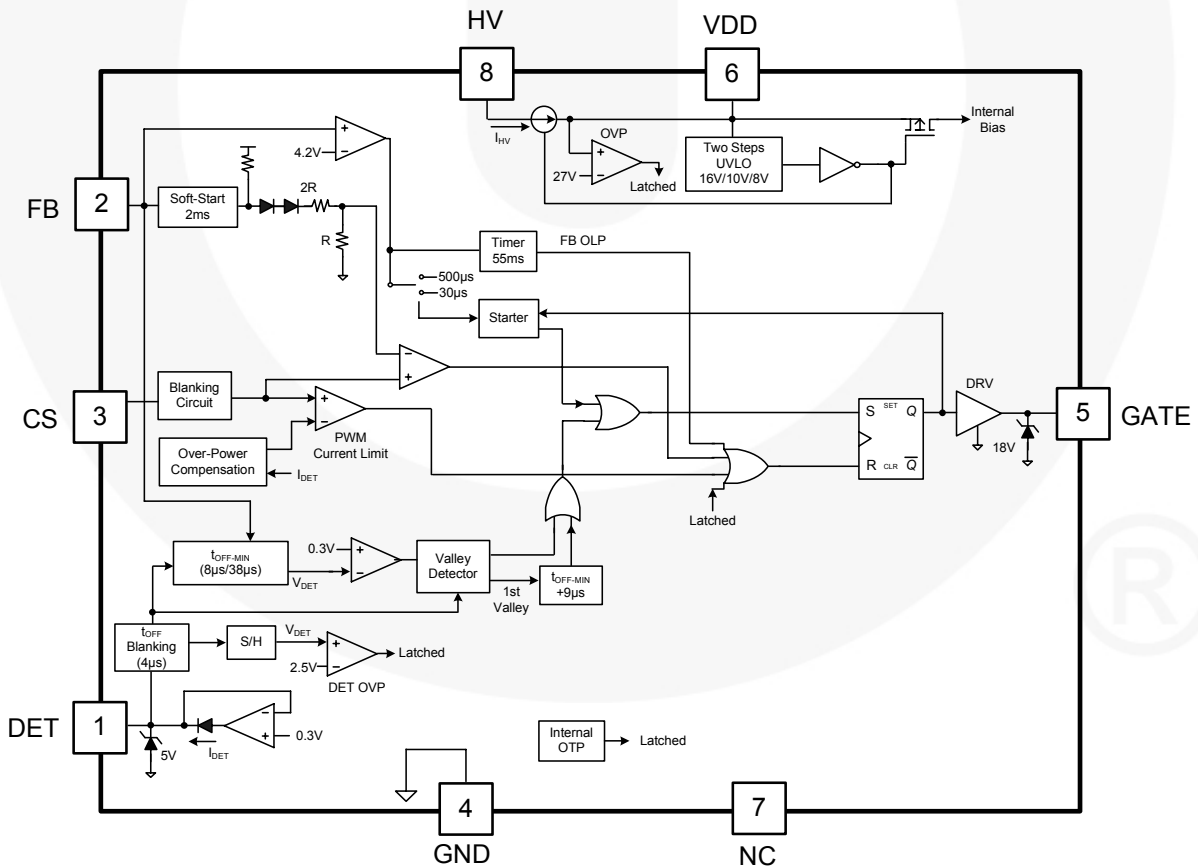

Figure 2. Functional Block Diagram

Marking Information

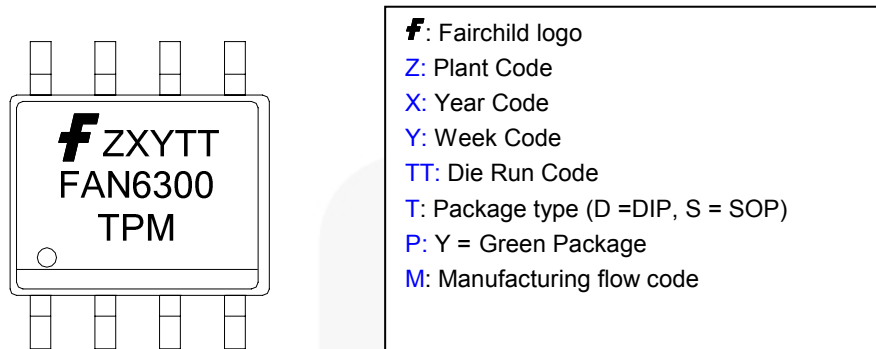

Figure 3. Marking Diagram

Pin Configuration

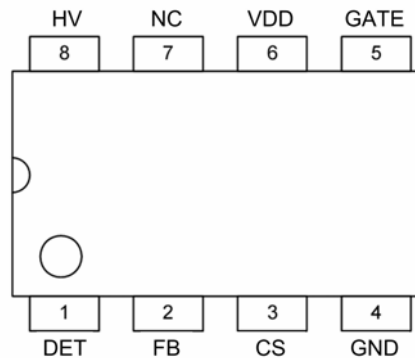

Figure 4. Pin Configuration

Pin Definitions

Pin #	Name	Description
1	DET	<p>This pin is connected to an auxiliary winding of the transformer via resistors of the divider for the following purposes:</p> <ul style="list-style-type: none"> Generates a ZCD signal once the secondary-side switching current falls to zero. Produces an offset voltage to compensate the threshold voltage of the peak current limit to provide a constant power limit. The offset is generated in accordance with the input voltage when PWM signal is enabled. Detects the valley voltage of the switching waveform to achieve the valley voltage switching and minimize the switching losses. <p>A voltage comparator and a 2.5V reference voltage develop an output OVP protection. The ratio of the divider decides what output voltage to stop gate, as an optical coupler and secondary shunt regulator are used.</p>
2	FB	<p>The Feedback pin is supposed to be connected to the output of the error amplifier for achieving the voltage control loop. The FB should be connected to the output of the optical coupler if the error-amplifier is equipped at the secondary-side of the power converter.</p> <p>For the primary-side control application, this pin is applied to connect a RC network to the ground for feedback-loop compensation.</p> <p>The input impedance of this pin is a 5kΩ equivalent resistance. A 1/3 attenuator connected between the FB and the PWM circuit is used for the loop gain attenuation.</p> <p>FAN6300 performs an open-loop protection once the FB voltage is higher than a threshold voltage (around 4.2V) more than 55ms.</p>

Pin #	Name	Description
3	CS	Input to the comparator of the over-current protection. A resistor senses the switching current and the resulting voltage is applied to this pin for the cycle-by-cycle current limit. The threshold voltage for peak current limit is 0.8V.
4	GND	The power ground and signal ground. A 0.1 μ F decoupling capacitor placed between V _{DD} and GND is recommended.
5	GATE	Totem-pole output generates the PWM signal to drive the external power MOSFET. The clamped gate output voltage is 18V.
6	VDD	Power supply. The threshold voltages for startup and turn-off are 16V and 10V. The startup current is less than 20 μ A and the operating current is lower than 4.5mA.
7	NC	No connect.
8	HV	High-voltage startup.



Absolute Maximum Ratings

Stresses exceeding the absolute maximum ratings may damage the device. The device may not function or be operable above the recommended operating conditions and stressing the parts to these levels is not recommended. In addition, extended exposure to stresses above the recommended operating conditions may affect device reliability. The absolute maximum ratings are stress ratings only.

Symbol	Parameter	Min.	Max.	Unit
V _{DD}	DC Supply Voltage		30	V
V _{HV}	HV Pin		500	V
V _H	GATE Pin	-0.3	25.0	V
V _L	V _{FB} , V _{CS} , V _{DET}	-0.3	7.0	V
P _D	Power Dissipation		400	mW
T _J	Operating Junction Temperature		+150	°C
T _{STG}	Storage Temperature Range	-55	+150	°C
T _L	Lead Temperature, Soldering 10 Seconds		+270	°C
ESD	Human Body Model, JEDEC:JESD22-A114		2.5	KV
	Charged Device Model, JEDEC:JESD22-C101		1.5	

Notes:

1. Stresses beyond those listed under Absolute Maximum Ratings may cause permanent damage to the device.
2. All voltage values, except differential voltages, are given with respect to GND pin.

Recommended Operating Conditions

The Recommended Operating Conditions table defines the conditions for actual device operation. Recommended operating conditions are specified to ensure optimal performance to the datasheet specifications. Fairchild does not recommend exceeding them or designing to Absolute Maximum Ratings.

Symbol	Parameter	Min.	Max.	Unit
T _A	Operating Ambient Temperature	-40	+105	°C

Electrical Characteristics

$V_{DD}=15V$, $T_A=25^{\circ}C$, unless otherwise specified.

Symbol	Parameter	Conditions	Min.	Typ.	Max.	Units
VDD SECTION						
V_{OP}	Continuously Operating Voltage				25	V
V_{DD-ON}	Turn-on Threshold Voltage		15	16	17	V
$V_{DD-PWM-OFF}$	PWM Off Threshold Voltage		9	10	11	V
V_{DD-OFF}	Turn-Off Threshold Voltage		7	8	9	V
I_{DD-ST}	Startup Current	$0V < V_{DD} < V_{DD-ON}$ GATE Open		10	30	μA
I_{DD-OP}	Operating Current	$V_{DD}=15V$, $f_s=60KHz$, $C_L=2nF$		4.5	5.5	mA
$I_{DD-PWM-OFF}$	Operating Current at PWM-Off Phase	$V_{DD}=V_{DD-PWM-OFF}-0.5V$	70	80	90	μA
V_{DD-OVP}	V_{DD} Over-Voltage Protection (Latch-Off)		26	27	28	V
$t_{VDD-OVP}$	V_{DD} OVP Debounce Time		100	150	200	μs
HV STARTUP CURRENT SOURCE SECTION						
I_{HV}	Supply Current Drawn From HV Pin	$V_{AC}=90V$ ($V_{DC}=120V$), $V_{DD}=0V$		1.2		mA
I_{HV-LC}	Leakage Current After Startup	$HV=500V$, $V_{DD}=V_{DD-OFF} + 1V$		1	20	μA
FEEDBACK INPUT SECTION						
A_V	Input-voltage to Current Sense Attenuation	$A_V=\Delta V_{CS}/\Delta V_{FB}$ $0 < V_{CS} < 0.9$	1/2.75	1/3.00	1/3.25	V/V
Z_{FB}	Input Impedance		3	5	7	K Ω
I_{OZ}	Bias Current	$FB=V_{OZ}$		1.2	2.0	mA
V_{OZ}	Zero Duty Cycle Input Voltage			1		V
V_{FB-OLP}	Open-Loop Protection Threshold Voltage		3.9	4.2	4.5	V
t_{D-OLP}	Debounce Time for Open-Loop / Overload Protection			55		ms
t_{SS}	Internal Soft-Start Time		1.6	2.0	2.4	ms
DET PIN OVP AND VALLEY DETECTION SECTION						
$V_{DET-OVP}$	Comparator Reference Voltage		2.45	2.50	2.55	V
V_{V-HIGH}	Output High Voltage		4.5			V
V_{V-LOW}	Output Low Voltage				0.5	V
$t_{DET-OVP}$	Output OVP (Latched) Debounce Time		100	150	200	μs
$I_{DET-SOURCE}$	Maximum Source Current				1	mA
$V_{DET-HIGH}$	Upper Clamp Voltage				5	V
$V_{DET-LOW}$	Lower Clamp Voltage		0.1	0.3		V
$t_{OFF-BNK}$	Leading-Edge Blanking Time for DET-OVP, PWM MOS Turns Off ⁽³⁾			4		μs

Note:

3. Guaranteed by design.

Electrical Characteristics (Continued)V_{DD}=15V, T_A=25°C, unless otherwise specified.

Symbol	Parameter	Conditions	Min.	Typ.	Max.	Units
OSCILLATOR SECTION						
t _{ON-MAX}	Maximum On Time		38	45	52	μs
t _{OFF-MIN}	Minimum Off Time (Maximum Frequency)	V _{FB} ≥ V _N	7	8	9	μs
		V _{FB} = V _G		38		μs
V _N	Beginning of Green-On Mode at FB Voltage Level		1.95	2.10	2.25	V
V _G	Beginning of Green-Off Mode at FB Voltage Level		1.05	1.20	1.35	V
ΔV _{F_{FB}}	Green-Off Mode V _{FB} Hysteresis Voltage			0.1		V
t _{STARTER}	Start Timer (Time-out Timer)	V _{FB} < V _G	450	550	650	μs
		V _{FB} > V _{FB-OLP}	25	30	35	μs
t _{TIME-OUT}	Timeout After t _{OFF-MIN} (If No Valley Signal)			9		μs
OUTPUT SECTION						
V _{OL}	Output Voltage Low	V _{DD} =15V, I _O =150mA			1.5	V
V _{OH}	Output Voltage High	V _{DD} =12V, I _O =150mA	7.5			V
t _R	Rising Time			120		ns
t _F	Falling Time			60		ns
V _{CLAMP}	GATE Output Clamping Voltage		17	18	19	V
CURRENT SENSE SECTION						
t _{PD}	Delay to Output			150	250	ns
V _{LIMIT}	Cycle-by-Cycle Current Limit Threshold Voltage	I _{DET} = 60μA	0.74	0.78	0.82	V
		I _{DET} = 175μA	0.545	0.585	0.625	V
		I _{DET} = 220μA	0.42	0.46	0.50	V
V _{SLOPE}	Slope Compensation	t _{ON} =45μs		0.3		V
		t _{ON} =0μs		0.1		V
t _{BNK}	Leading Edge Blanking Time (MOS Turns On)		225	300	375	ns
V _{CS-H}	V _{CS} Camped High Voltage	CS Pin Floating	4.5		5.0	V
t _{CS-H}	Delay Time	CS Pin Floating	100	150	200	μs

Typical Performance Characteristics

These characteristic graphs are normalized at $T_A = 25^\circ\text{C}$.

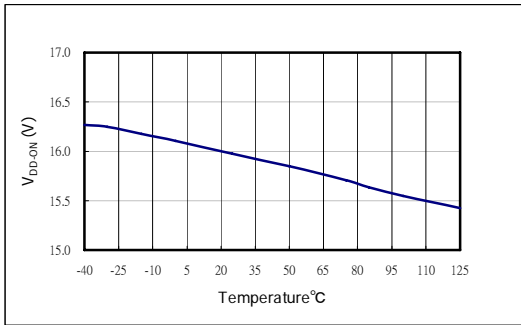

Figure 5. Turn-on Threshold Voltage

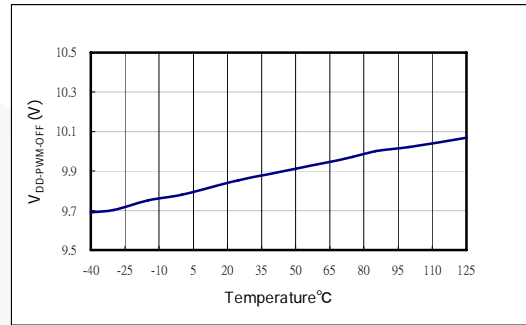

Figure 6. PWM Off Threshold Voltage

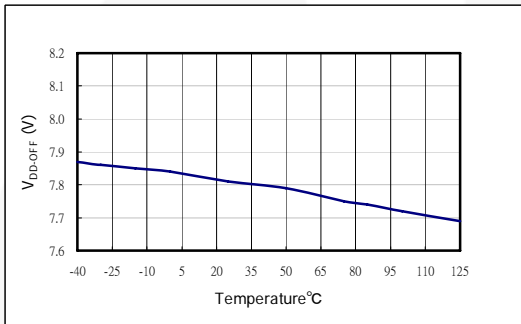

Figure 7. Turn-off Threshold Voltage

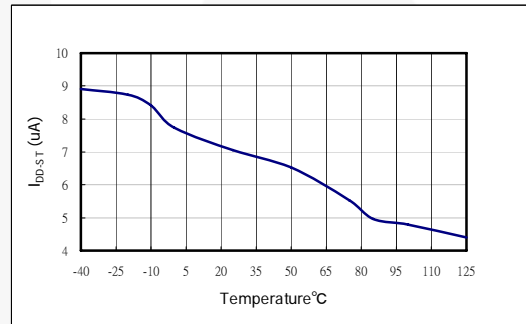

Figure 8. Startup Current

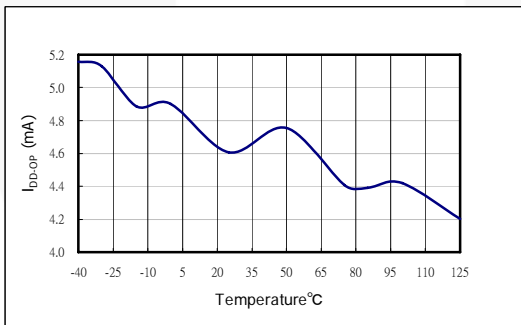

Figure 9. Operating Current

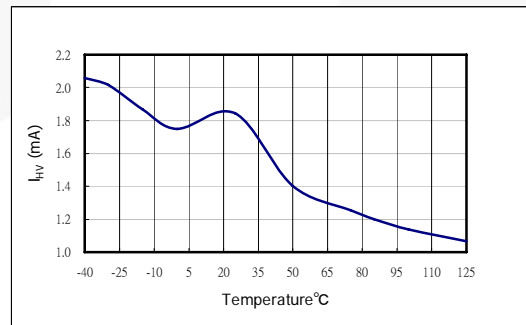

Figure 10. Supply Current Drawn From HV Pin

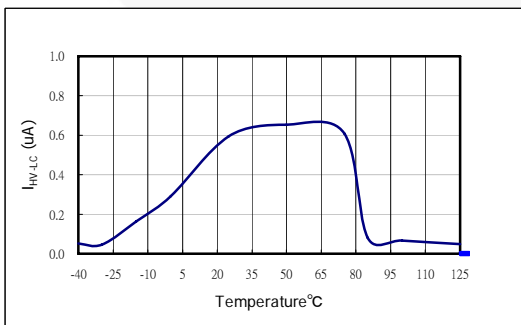

Figure 11. Leakage Current After Startup

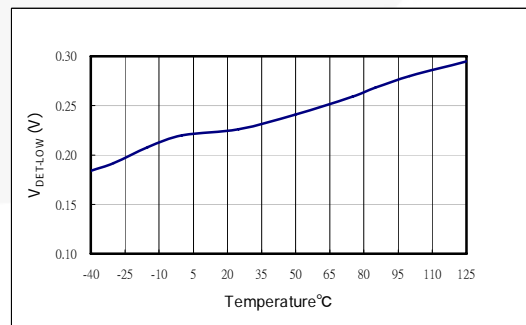

Figure 12. Lower Clamp Voltage

Typical Performance Characteristics

These characteristic graphs are normalized at $T_A = 25^\circ\text{C}$.

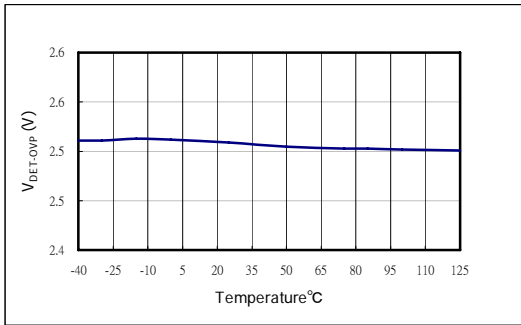

Figure 13. Comparator Reference Voltage

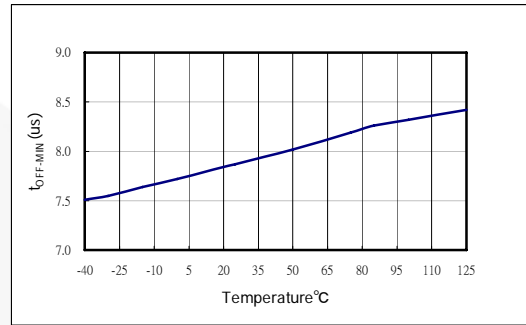

Figure 14. Minimum Off Time ($V_{FB} > V_N$)

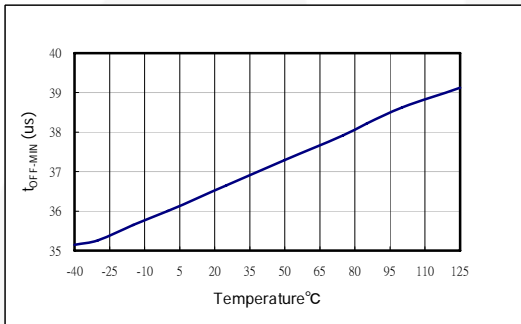

Figure 15. Minimum Off Time ($V_{FB} = V_G$)

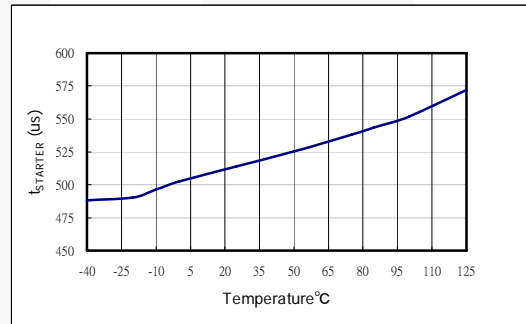

Figure 16. Start Timer ($V_{FB} < V_G$)

Operation Description

The FAN6300 of PWM controller integrates designs to enhance the performance of flyback converters. An internal valley voltage detector ensures power system operates at Quasi-Resonant (QR) operation in a wide range of line voltage. The following descriptions highlight some of the features of the FAN6300 series.

Startup Current

For startup, the HV pin is connected to the line input or bulk capacitor through an external diode and resistor, R_{HV} , which are recommended as 1N4007 and 100k Ω . Typical startup current drawn from pin HV is 1.2mA and it charges the hold-up capacitor through the diode and resistor. When the V_{DD} voltage level reaches V_{DD-ON} , the startup current switches off. At this moment, the V_{DD} capacitor only supplies the FAN6300 to maintain V_{DD} until the auxiliary winding of the main transformer provides the operating current.

Valley Detection

The DET pin is connected to an auxiliary winding of the transformer via resistors of the divider to generate a valley signal once the secondary-side switching current discharges to zero. It detects the valley voltage of the switching waveform to achieve the valley voltage switching. This ensures QR operation, minimizes switching losses, and reduces EMI. Figure 17 shows divider resistors R_{DET} and R_A . R_{DET} is recommended as 150k Ω to 220k Ω to achieve valley voltage switching. When V_{AUX} (in Figure 17) is negative, the DET pin voltage is clamped to 0.3V.

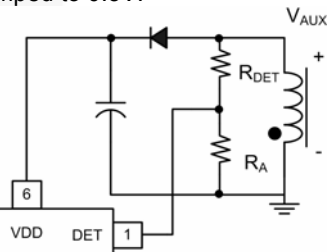

Figure 17. Valley Detect Section

The internal timer (minimum t_{OFF} time) prevents gate retriggering within 8 μ s after the gate signal going-low transition. The minimum t_{OFF} time limit prevents the system frequency being too high. Figure 18 shows a typical drain voltage waveform with first valley switching.

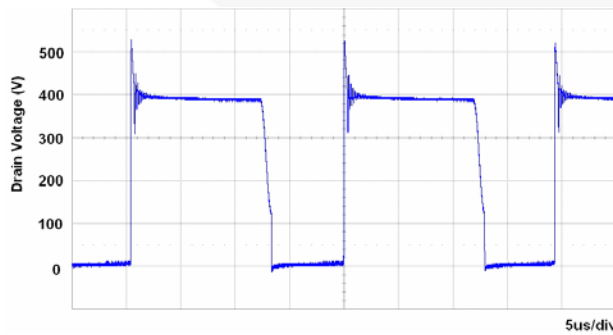

Figure 18. First Valley Switching

Green-Mode Operation

The proprietary green-mode function provides off-time modulation to linearly decrease the switching frequency under light-load conditions. V_{FB} , which is derived from the voltage feedback loop, is taken as the reference. In Figure 19, once V_{FB} is lower than V_N , the $t_{OFF-MIN}$ increases linearly with lower V_{FB} . The valley voltage detection signal does not start until the $t_{OFF-MIN}$ time finishes. Therefore, the valley detect circuit is activated until the $t_{OFF-MIN}$ time finishes, which decreases the switching frequency and provides extended valley voltage switching. However, in very light load condition, it might fail to detect the valley voltage after the $t_{OFF-MIN}$ expires. Under this condition, an internal $t_{TIME-OUT}$ signal initiates a new cycle start after a 9 μ s delay. Figure 20 and Figure 21 show the two different conditions.

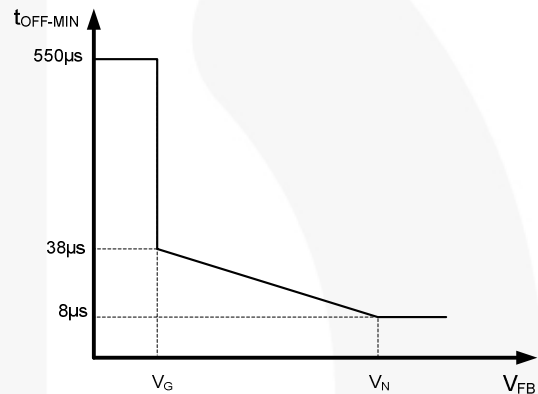

Figure 19. V_{FB} vs. $t_{OFF-MIN}$ Curve

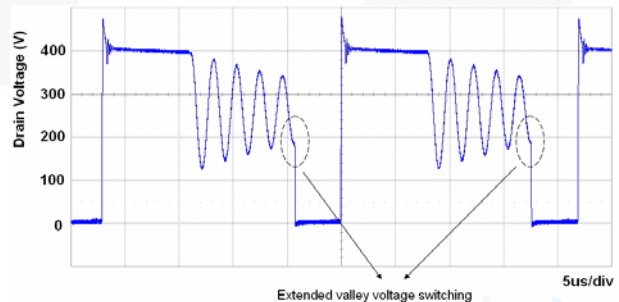

Figure 20. QR Operation in Extended Valley Voltage Detection Mode

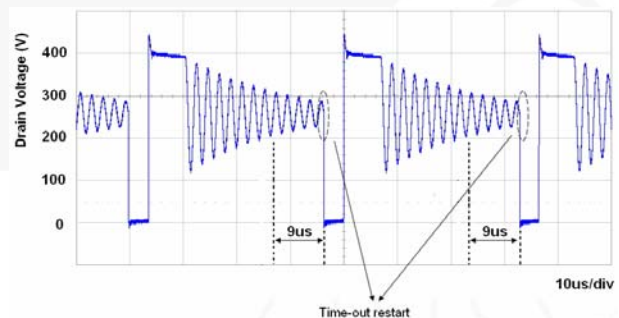

Figure 21. Internal $t_{TIME-OUT}$ Initiates New Cycle After Failure to Detect Valley Voltage (with 9 μ s Delay)

Current Sensing and PWM Current Limiting

Peak-current-mode control is utilized to regulate output voltage and provide pulse-by-pulse current limiting. The switch current is detected by a sense resistor into the CS pin. The PWM duty cycle is determined by this current sense signal and V_{FB} . When the voltage on CS pin reaches around $V_{LIMIT} = (V_{FB}-1.2)/3$, the switch cycle is terminated immediately. V_{LIMIT} is internally clamped to a variable voltage around 0.8V for output power limit.

Leading Edge Blanking (LEB)

Each time the power MOSFET switches on, a turn-on spike occurs on the sense resistor. To avoid premature termination of the switching pulse, lead-edge blanking time is built in. During the blanking period, the current limit comparator is disabled; it cannot switch off the gate driver.

Under-Voltage Lockout (UVLO)

The turn-on, PWM-off, and turn-off thresholds are fixed internally at 16/10/8V. During startup, the startup capacitor must be charged to 16V through the startup resistor to enable the IC. The hold-up capacitor continues to supply V_{DD} until energy can be delivered from the auxiliary winding of the main transformer. V_{DD} must not drop below 10V during this startup process. This UVLO hysteresis window ensures that hold-up capacitor is adequate to supply V_{DD} during startup.

Gate Output

The BiCMOS output stage is a fast totem-pole gate driver. Cross conduction has been avoided to minimize heat dissipation, increase efficiency, and enhance reliability. The output driver is clamped by an internal 18V Zener diode to protect power MOSFET transistors against undesired over-voltage gate signals.

Over-Power Compensation

To compensate this variation for wide AC input range, the DET pin produces an offset voltage to compensate the threshold voltage of the peak current limit to provide a constant-power limit. The offset is generated in accordance with the input voltage when PWM signal is enabled. This results in a lower current limit at high-line inputs than low-line inputs. At fixed-load condition, the CS limit is higher when the value of R_{DET} is higher. R_{DET} also affects the H/L line constant power limit.

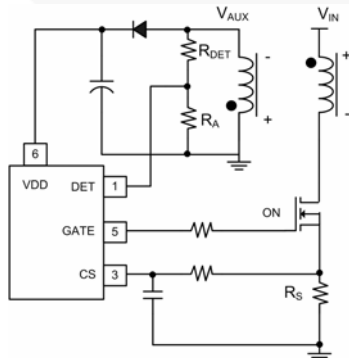

Figure 22. H/L Line Constant Power Limit Compensated by DET Pin

V_{DD} Over-Voltage Protection

V_{DD} over-voltage protection prevents damage due to abnormal conditions. Once the V_{DD} voltage is over the V_{DD} over-voltage protection voltage (V_{DD-OVP}) and lasts for t_{VDDOVP} , controller enters latch mode and stops all switching operation.

Output Over-Voltage Protection

The output over-voltage protection works by the sampling voltage, as shown in Figure 23, after switch-off sequence. A $4\mu s$ blanking time ignores the leakage inductance ringing. A voltage comparator and a 2.5V reference voltage develop an output OVP protection. The ratio of the divider determines the sampling voltage of the stop gate, as an optical coupler and secondary shunt regulator are used. If the DET pin OVP is triggered, power system enters latch-mode until AC power is removed.

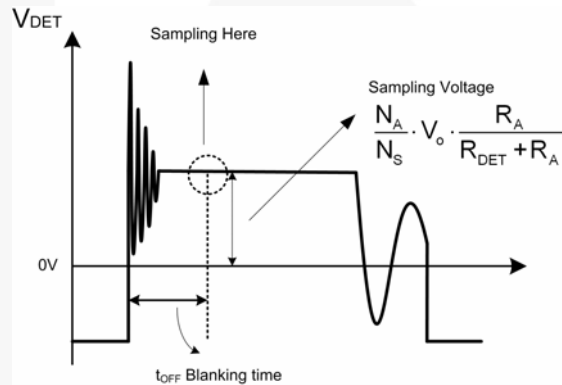

Figure 23. Voltage Sampled After $4\mu s$ Blanking Time After Switch-off Sequence

Short-Circuit and Open-Loop Protection

The FB voltage increases every time the output of the power supply is shorted or overloaded. If the FB voltage remains higher than a built-in threshold for longer than t_{D-OLP} , PWM output is turned off. As PWM output is turned-off, the supply voltage V_{DD} begins decreasing.

When V_{DD} goes below the PWM-off threshold of 10V, V_{DD} decreases to 8V, then the controller is totally shut down. V_{DD} is charged up to the turn-on threshold voltage of 16V through the startup resistor until PWM output is restarted. This protection feature continues as long as the overloading condition persists. This prevents the power supply from overheating due to overloading.

Physical Dimensions

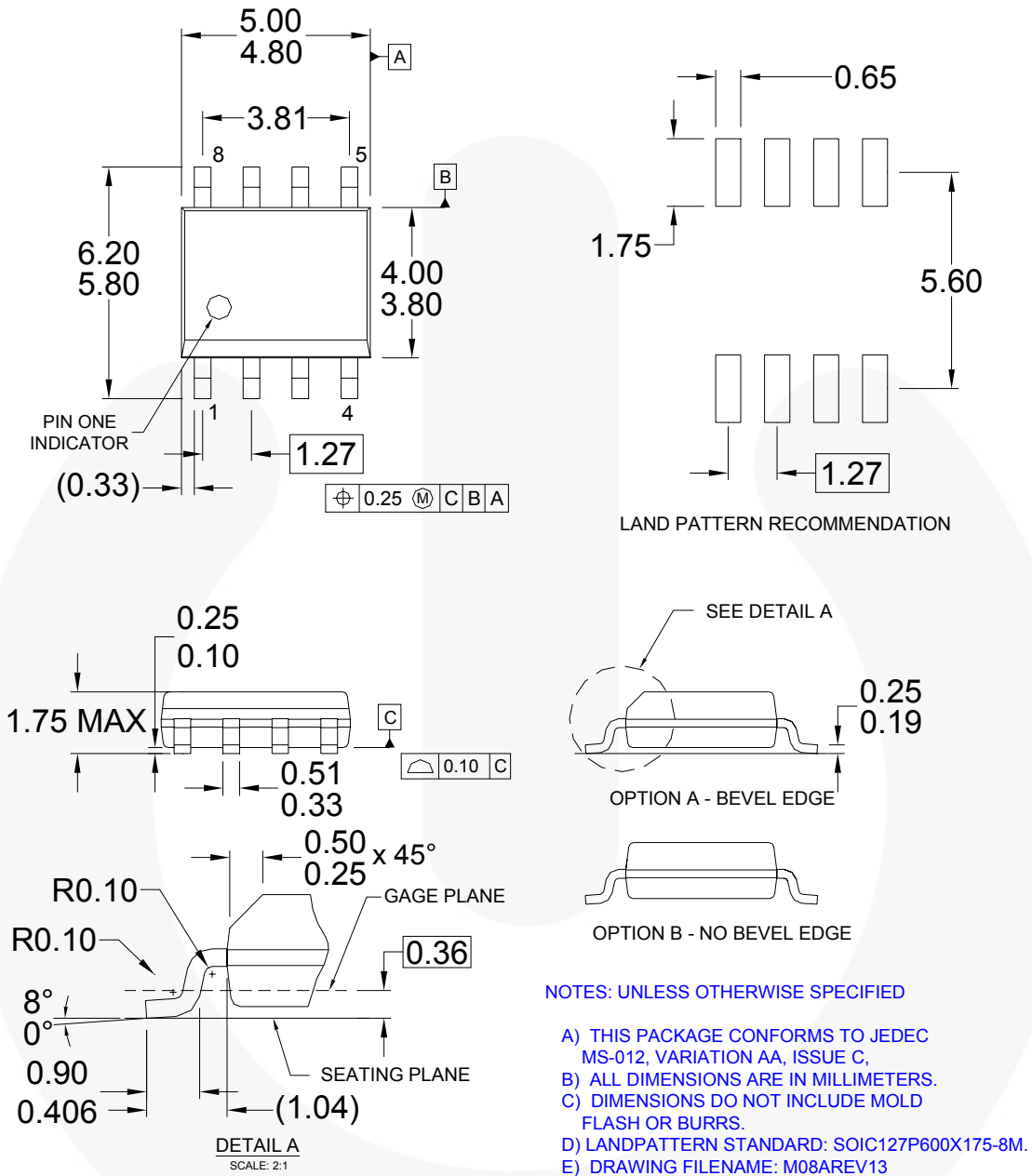
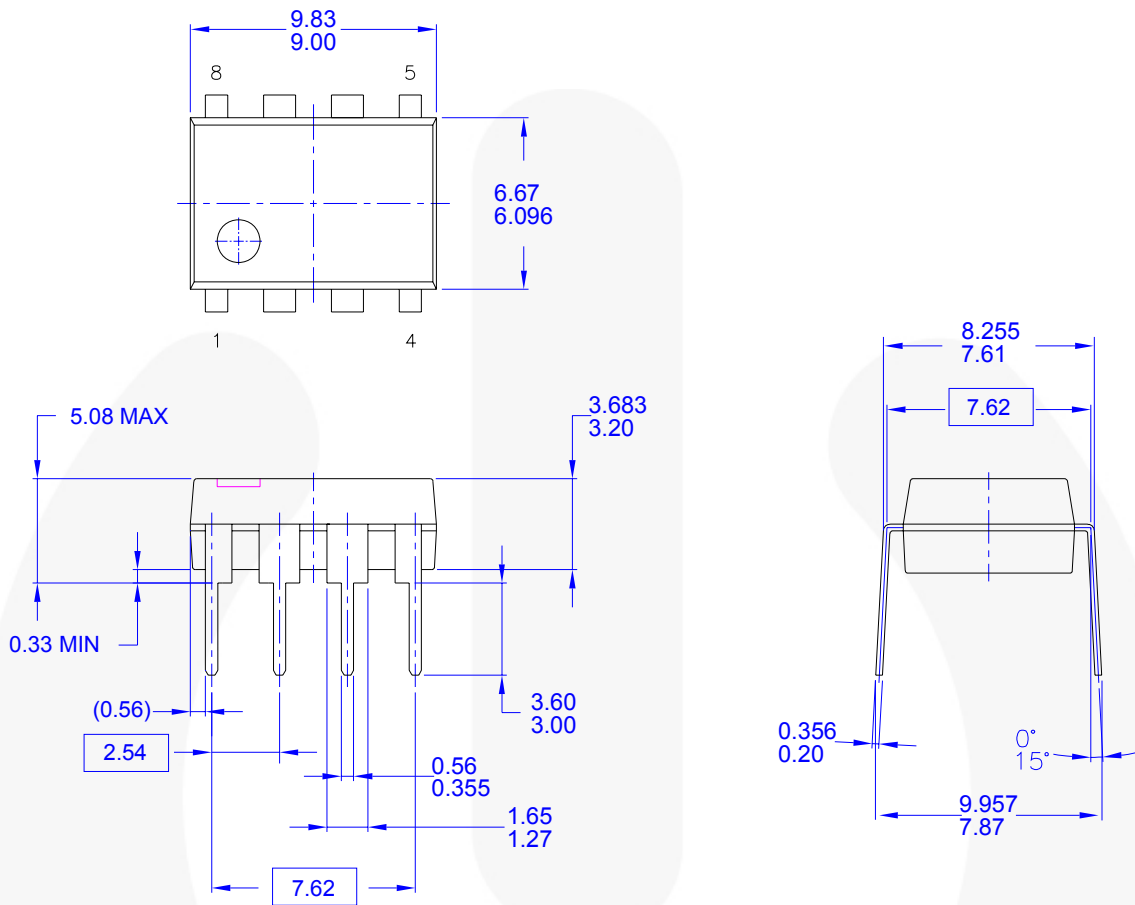

Figure 24. 8-Pin Small Outline Package (SOP)

Package drawings are provided as a service to customers considering Fairchild components. Drawings may change in any manner without notice. Please note the revision and/or date on the drawing and contact a Fairchild Semiconductor representative to verify or obtain the most recent revision. Package specifications do not expand the terms of Fairchild's worldwide terms and conditions, specifically the warranty therein, which covers Fairchild products.

Always visit Fairchild Semiconductor's online packaging area for the most recent package drawings:
<http://www.fairchildsemi.com/packaging/>.

Physical Dimensions (Continued)



- NOTES: UNLESS OTHERWISE SPECIFIED
- A) THIS PACKAGE CONFORMS TO JEDEC MS-001 VARIATION BA
 - B) ALL DIMENSIONS ARE IN MILLIMETERS.
 - C) DIMENSIONS ARE EXCLUSIVE OF BURRS, MOLD FLASH, AND TIE BAR EXTRUSIONS.
 - D) DIMENSIONS AND TOLERANCES PER ASME Y14.5M-1994
 - E) DRAWING FILENAME AND REVISION: MKT-N08FRE2.

Figure 25. 8-Pin Dual Inline Package (DIP-8)







Package drawings are provided as a service to customers considering Fairchild components. Drawings may change in any manner without notice. Please note the revision and/or date on the drawing and contact a Fairchild Semiconductor representative to verify or obtain the most recent revision. Package specifications do not expand the terms of Fairchild's worldwide terms and conditions, specifically the warranty therein, which covers Fairchild products.

Always visit Fairchild Semiconductor's online packaging area for the most recent package drawings:
<http://www.fairchildsemi.com/packaging/>.



TRADEMARKS

The following includes registered and unregistered trademarks and service marks, owned by Fairchild Semiconductor and/or its global subsidiaries, and is not intended to be an exhaustive list of all such trademarks.

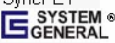
- | | | | |
|---|---|---|---|
| Build it Now™ | FRFET® | Programmable Active Droop™ |  |
| CorePLUS™ | Global Power Resource™ SM | QFET® | |
| CorePOWER™ | Green FPST™ | QS™ | |
| CROSSVOLT™ | Green FPST™ e-Series™ | Quiet Series™ | |
| CTL™ | GTO™ | RapidConfigure™ | |
| Current Transfer Logic™ | IntelliMAX™ |  ™ | |
| EcoSPARK® | ISOPLANAR™ | Saving our world, 1mW/W/kW at a time™ | |
| EfficientMax™ | MegaBuck™ | SmartMax™ | |
| EZSWTCH™ * | MICROCOUPLER™ | SMART START™ | |
|  ™ | MicroFET™ | SPM® | |
|  ™ | MicroPak™ | STEALTH™ | |
| Fairchild® | MillerDrive™ | SuperFET™ |  |
| Fairchild Semiconductor® | MotionMax™ | SuperSOT™.3 | |
| FACT Quiet Series™ | Motion-SPM™ | SuperSOT™.6 | |
| FACT® | OPTOLOGIC® | SuperSOT™.8 | |
| FAST® | OPTOPLANAR® | SupreMOS™ | |
| FastvCore™ |  ™ | SyncFET™ | |
| FlashWriter® * | PDP SPM™ |  ™ | |
| FPS™ | Power-SPM™ | The Power Franchise® | |
| F-PFST™ | PowerTrench® | | |
| | PowerXS™ | | |

* EZSWTCH™ and FlashWriter® are trademarks of System General Corporation, used under license by Fairchild Semiconductor.

DISCLAIMER

FAIRCHILD SEMICONDUCTOR RESERVES THE RIGHT TO MAKE CHANGES WITHOUT FURTHER NOTICE TO ANY PRODUCTS HEREIN TO IMPROVE RELIABILITY, FUNCTION, OR DESIGN. FAIRCHILD DOES NOT ASSUME ANY LIABILITY ARISING OUT OF THE APPLICATION OR USE OF ANY PRODUCT OR CIRCUIT DESCRIBED HEREIN; NEITHER DOES IT CONVEY ANY LICENSE UNDER ITS PATENT RIGHTS, NOR THE RIGHTS OF OTHERS. THESE SPECIFICATIONS DO NOT EXPAND THE TERMS OF FAIRCHILD'S WORLDWIDE TERMS AND CONDITIONS, SPECIFICALLY THE WARRANTY THEREIN, WHICH COVERS THESE PRODUCTS.

LIFE SUPPORT POLICY

FAIRCHILD'S PRODUCTS ARE NOT AUTHORIZED FOR USE AS CRITICAL COMPONENTS IN LIFE SUPPORT DEVICES OR SYSTEMS WITHOUT THE EXPRESS WRITTEN APPROVAL OF FAIRCHILD SEMICONDUCTOR CORPORATION.

As used herein:

- Life support devices or systems are devices or systems which, (a) are intended for surgical implant into the body or (b) support or sustain life, and (c) whose failure to perform when properly used in accordance with instructions for use provided in the labeling, can be reasonably expected to result in a significant injury of the user.
- A critical component in any component of a life support, device, or system whose failure to perform can be reasonably expected to cause the failure of the life support device or system, or to affect its safety or effectiveness.

ANTI-COUNTERFEITING POLICY

Fairchild Semiconductor Corporation's Anti-Counterfeiting Policy. Fairchild's Anti-Counterfeiting Policy is also stated on our external website, www.fairchildsemi.com, under Sales Support.

Counterfeiting of semiconductor parts is a growing problem in the industry. All manufacturers of semiconductor products are experiencing counterfeiting of their parts. Customers who inadvertently purchase counterfeit parts experience many problems such as loss of brand reputation, substandard performance, failed applications, and increased cost of production and manufacturing delays. Fairchild is taking strong measures to protect ourselves and our customers from the proliferation of counterfeit parts. Fairchild strongly encourages customers to purchase Fairchild parts either directly from Fairchild or from Authorized Fairchild Distributors who are listed by country on our web page cited above. Products customers buy either from Fairchild directly or from Authorized Fairchild Distributors are genuine parts, have full traceability, meet Fairchild's quality standards for handling and storage and provide access to Fairchild's full range of up-to-date technical and product information. Fairchild and our Authorized Distributors will stand behind all warranties and will appropriately address any warranty issues that may arise. Fairchild will not provide any warranty coverage or other assistance for parts bought from Unauthorized Sources. Fairchild is committed to combat this global problem and encourage our customers to do their part in stopping this practice by buying direct or from authorized distributors.

PRODUCT STATUS DEFINITIONS

Definition of Terms

Datasheet Identification	Product Status	Definition
Advance Information	Formative / In Design	Datasheet contains the design specifications for product development. Specifications may change in any manner without notice.
Preliminary	First Production	Datasheet contains preliminary data; supplementary data will be published at a later date. Fairchild Semiconductor reserves the right to make changes at any time without notice to improve design.
No Identification Needed	Full Production	Datasheet contains final specifications. Fairchild Semiconductor reserves the right to make changes at any time without notice to improve the design.
Obsolete	Not In Production	Datasheet contains specifications on a product that is discontinued by Fairchild Semiconductor. The datasheet is for reference information only.

Rev. I37

ON Semiconductor and  are trademarks of Semiconductor Components Industries, LLC dba ON Semiconductor or its subsidiaries in the United States and/or other countries. ON Semiconductor owns the rights to a number of patents, trademarks, copyrights, trade secrets, and other intellectual property. A listing of ON Semiconductor's product/patent coverage may be accessed at www.onsemi.com/site/pdf/Patent-Marking.pdf. ON Semiconductor reserves the right to make changes without further notice to any products herein. ON Semiconductor makes no warranty, representation or guarantee regarding the suitability of its products for any particular purpose, nor does ON Semiconductor assume any liability arising out of the application or use of any product or circuit, and specifically disclaims any and all liability, including without limitation special, consequential or incidental damages. Buyer is responsible for its products and applications using ON Semiconductor products, including compliance with all laws, regulations and safety requirements or standards, regardless of any support or applications information provided by ON Semiconductor. "Typical" parameters which may be provided in ON Semiconductor data sheets and/or specifications can and do vary in different applications and actual performance may vary over time. All operating parameters, including "Typicals" must be validated for each customer application by customer's technical experts. ON Semiconductor does not convey any license under its patent rights nor the rights of others. ON Semiconductor products are not designed, intended, or authorized for use as a critical component in life support systems or any FDA Class 3 medical devices or medical devices with a same or similar classification in a foreign jurisdiction or any devices intended for implantation in the human body. Should Buyer purchase or use ON Semiconductor products for any such unintended or unauthorized application, Buyer shall indemnify and hold ON Semiconductor and its officers, employees, subsidiaries, affiliates, and distributors harmless against all claims, costs, damages, and expenses, and reasonable attorney fees arising out of, directly or indirectly, any claim of personal injury or death associated with such unintended or unauthorized use, even if such claim alleges that ON Semiconductor was negligent regarding the design or manufacture of the part. ON Semiconductor is an Equal Opportunity/Affirmative Action Employer. This literature is subject to all applicable copyright laws and is not for resale in any manner.

PUBLICATION ORDERING INFORMATION

LITERATURE FULFILLMENT:

Literature Distribution Center for ON Semiconductor
19521 E. 32nd Pkwy, Aurora, Colorado 80011 USA
Phone: 303-675-2175 or 800-344-3860 Toll Free USA/Canada
Fax: 303-675-2176 or 800-344-3867 Toll Free USA/Canada
Email: orderlit@onsemi.com

N. American Technical Support: 800-282-9855 Toll Free
USA/Canada
Europe, Middle East and Africa Technical Support:
Phone: 421 33 790 2910
Japan Customer Focus Center
Phone: 81-3-5817-1050

ON Semiconductor Website: www.onsemi.com
Order Literature: <http://www.onsemi.com/orderlit>
For additional information, please contact your local
Sales Representative