

DBA100G

10.0A Single-Phase Bridge Rectifier



ON Semiconductor®

www.onsemi.com

Features

- Plastic molded structure
- Glass passivation for high reliability
- Peak reverse voltage: $V_{RM}=600V$
- Average rectified current: $I_O=10.0A$

SPECIFICATIONS

ABSOLUTE MAXIMUM RATINGS at $T_a = 25^{\circ}C$ (Note 1)

Parameter	Symbol	Value	Unit
Peak Reverse Voltage	V_{RM}	600	V
Average Rectified Current $T_a = 40^{\circ}C$	I_O	3.7	A
Average Rectified Current $T_a = 40^{\circ}C$ with $200 \times 200 \times 1.5mm^3$ Al fin		10.0	A
Surge Forward Current	I_{FSM}	200	A
Junction Temperature	T_j	150	$^{\circ}C$
Storage Temperature	T_{stg}	-30 to +150	$^{\circ}C$

Note 1 : Stresses exceeding those listed in the Maximum Ratings table may damage the device. If any of these limits are exceeded, device functionality should not be assumed, damage may occur and reliability may be affected.

ELECTRICAL CONNECTION

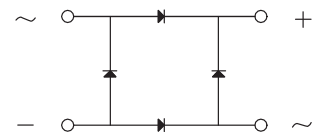
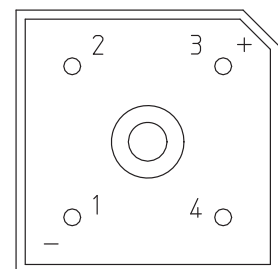

MARKING

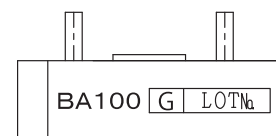

ORDERING INFORMATION

See detailed ordering and shipping information on page 4 of this data sheet

DBA100G

ELECTRICAL CHARACTERISTICS at $T_a = 25^\circ\text{C}$ (Note 2)

Parameter	Symbol	Conditions	Value			Unit
			min	typ	max	
Forward Voltage	V_F	$I_F = 5.0\text{A}$			1.05	V
Reverse Current	I_R	V_R : At each V_{RM}			10	μA

Note 2 : Product parametric performance is indicated in the Electrical Characteristics for the listed test conditions, unless otherwise noted.
 Product performance may not be indicated by the Electrical Characteristics if operated under different conditions.

Note 3 : Mounting torque : 0.49N·m max.

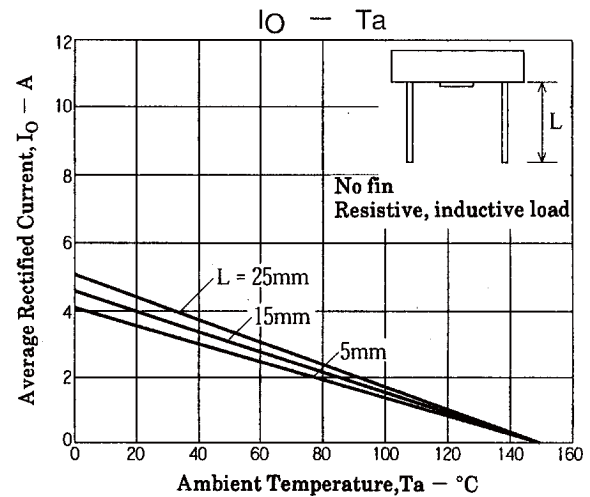
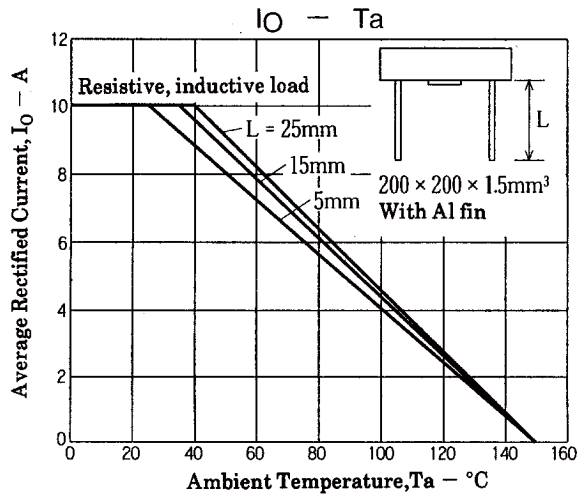
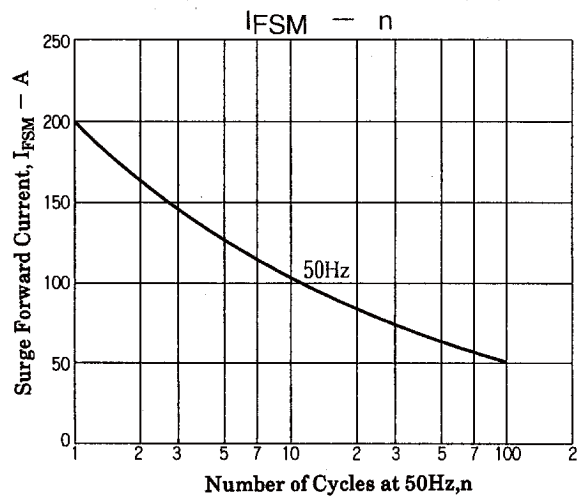
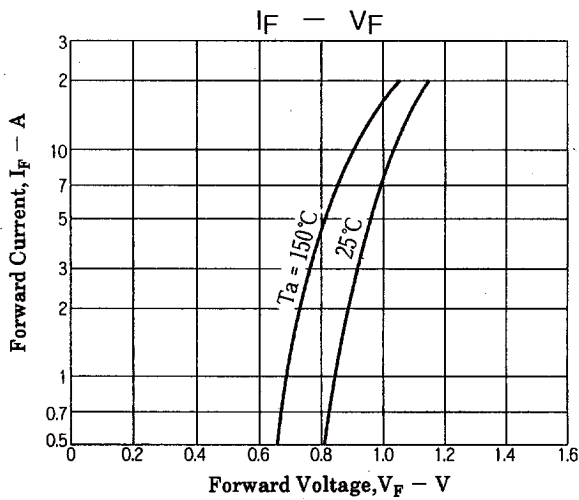

DBA100G

PACKAGE DIMENSIONS

unit : mm

GBPC-W 21.8x21.8 / DBA100

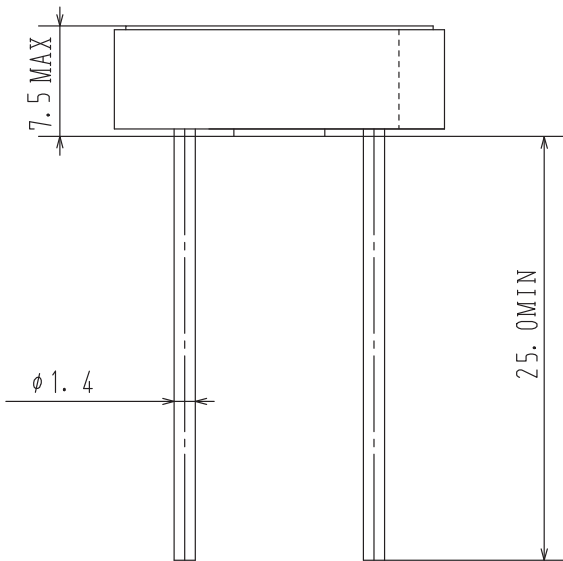
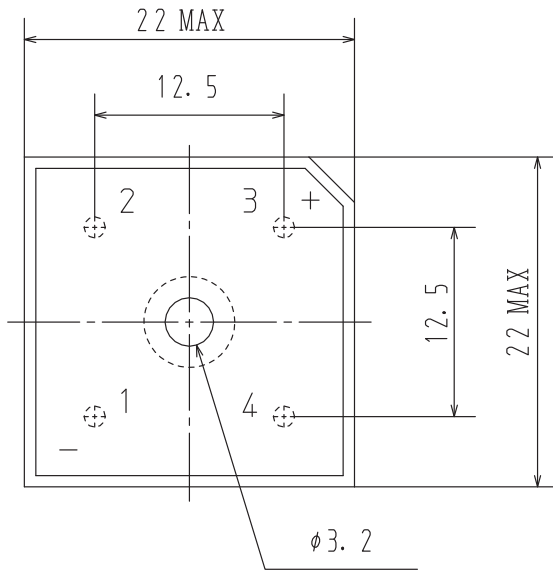

DBA100G

ORDERING INFORMATION

Device	Marking	Package	Shipping
DBA100G	BA100G	GBPC-W 21.8x21.8 / DBA100 (Pb-Free)	100pcs / Tray 1,000pcs / Box

ON Semiconductor and the ON logo are registered trademarks of Semiconductor Components Industries, LLC (SCILLC) or its subsidiaries in the United States and/or other countries. SCILLC owns the rights to a number of patents, trademarks, copyrights, trade secrets, and other intellectual property. A listing of SCILLC's product/patent coverage may be accessed at www.onsemi.com/site/pdf/Patent-Marking.pdf. SCILLC reserves the right to make changes without further notice to any products herein. SCILLC makes no warranty, representation or guarantee regarding the suitability of its products for any particular purpose, nor does SCILLC assume any liability arising out of the application or use of any product or circuit, and specifically disclaims any and all liability, including without limitation special, consequential or incidental damages. "Typical" parameters which may be provided in SCILLC data sheets and/or specifications can and do vary in different applications and actual performance may vary over time. All operating parameters, including "Typicals" must be validated for each customer application by customer's technical experts. SCILLC does not convey any license under its patent rights nor the rights of others. SCILLC products are not designed, intended, or authorized for use as components in systems intended for surgical implant into the body, or other applications intended to support or sustain life, or for any other application in which the failure of the SCILLC product could create a situation where personal injury or death may occur. Should Buyer purchase or use SCILLC products for any such unintended or unauthorized application, Buyer shall indemnify and hold SCILLC and its officers, employees, subsidiaries, affiliates, and distributors harmless against all claims, costs, damages, and expenses, and reasonable attorney fees arising out of, directly or indirectly, any claim of personal injury or death associated with such unintended or unauthorized use, even if such claim alleges that SCILLC was negligent regarding the design or manufacture of the part. SCILLC is an Equal Opportunity/Affirmative Action Employer. This literature is subject to all applicable copyright laws and is not for resale in any manner.