

XW2R

Conversion Unit with Industrial Standard *e-CON* Terminal Block Connectors

- Power supply terminals provided. Connector terminal blocks provided for wiring.
- I/O connectors for easier wiring.
- Easy connections via connectors (no special tools required).
- Compatible with e-CON connectors from other companies.

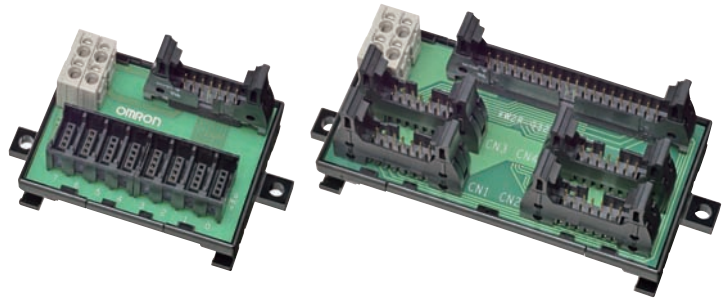

Connection Example

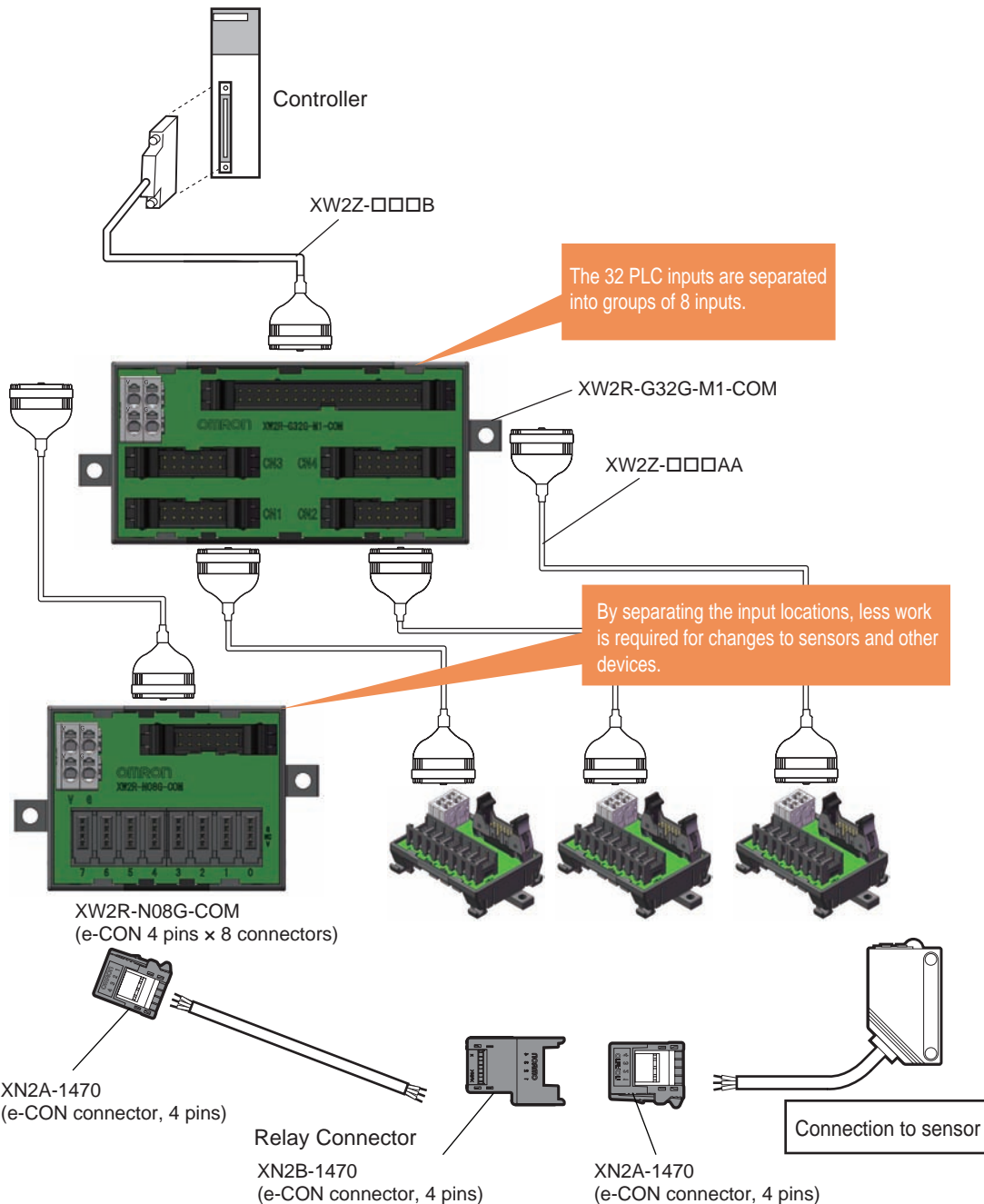

Ordering Information

Appearance	I/O points	Number of PLC connector pins	I/O	Model	Mounted Connector model	Cable Connector Model
	8	14	Inputs	XW2R-N08G-COM	XG4A-1431 (PLC side) XN2D-4471 (input side)	XG4M-1430-T (PLC side) XN2A-1470 (input side)

Ratings and Specifications

Rated current	Power supply terminal block: 2 A, Connectors (including e-CON Connectors): 1 A (However, rated current of e-CON Connector depends on the wires that are used.)	
Rated voltage	24 VDC	
Insulation resistance	100 MΩ min. (at 500 VDC)	
Dielectric strength	500 VAC for 1 min (leakage current: 1 mA max.)	
Ambient operating temperature	0 to 55°C	
Applicable wires (power supply terminal block)	Applicable wire sizes*	AWG 24 to 14 (ferrules), AWG 28 to 14 (twisted wires), AWG 28 to 16 (solid wires) (Outer diameter of insulation must be 4 mm max.)
	Stripped length	AWG28 to 16: 8 to 10 mm, AWG14: 9 to 10 mm

*This is the applicable range for the power supply terminal block. For the applicable wire sizes for I/O Connectors (e-CON), refer to information on the applied Connectors.

Wiring Diagram

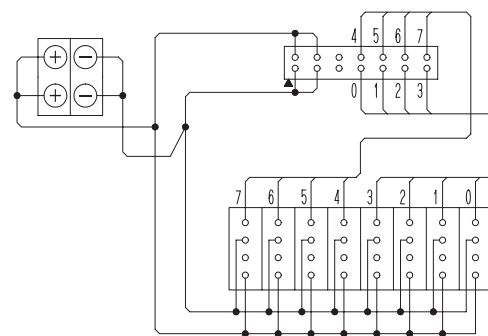

(This connection diagram is for combining with CN1 on the XW2R-G32G-M1-COM.)

Dimensions

(Unit: mm)

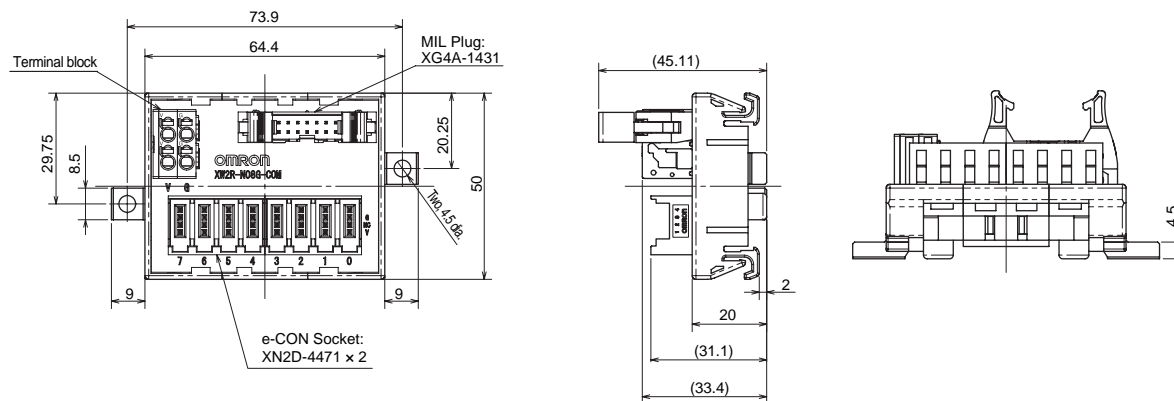

The e-CON address assignments are for combining the XW2R-G32G-M1-COM with four XW2R-N08G-COM.

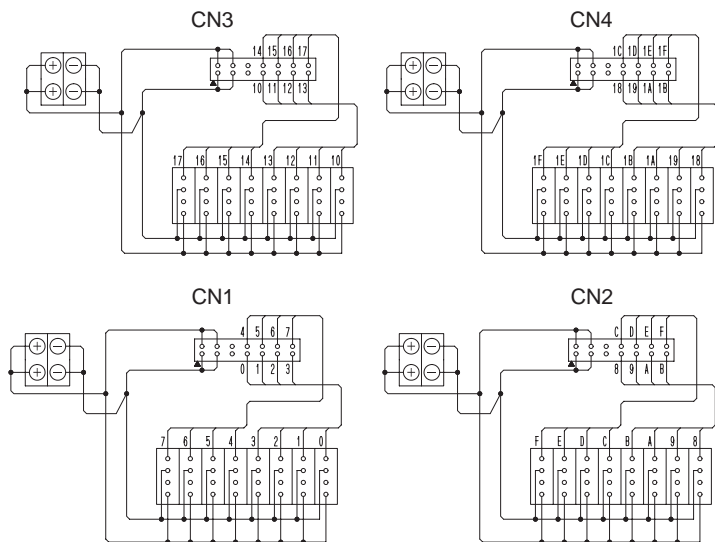

XW2Z Cables

Ratings and Specifications

Rated current	1 A
Rated voltage	125 VAC/24 VDC
Contact resistance	20 mΩ max. (at 20 mV, 100 mA max.) ^{*1}
Insulation resistance	100 MΩ min. (at 500 VDC)
Dielectric strength	500 VAC for 1 min (leakage current: 1 mA max.) ^{*2}
Ambient operating temperature	-25 to 80°C

*1. This is the contact resistance of the Connectors.

*2. This is the dielectric strength of the Connectors.

XW2Z-□□□B Connectors: One 40-pin Connector Made by Fujitsu Component, Ltd. to One 40-pin MIL Connector

Appearance	Model	Cable length (m)
	XW2Z-050B	0.5
	XW2Z-100B	1
	XW2Z-150B	1.5
	XW2Z-200B	2
	XW2Z-300B	3
	XW2Z-500B	5
	XW2Z-700B	7
	XW2Z-010B	10
	XW2Z-15MB	15
	XW2Z-20MB	20

Wiring Diagram

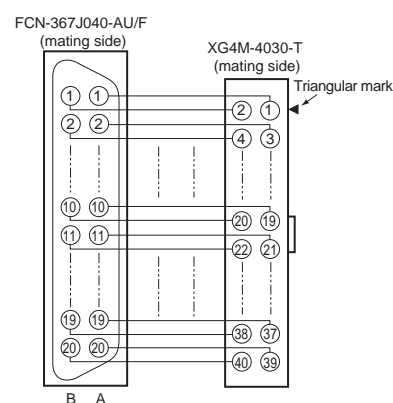

Cable Length (m)

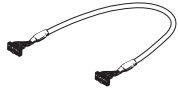

XW2Z-□□□AA MIL Connectors: One 14-pin MIL Connector to One 14-Pin MIL Connector

Appearance	Model	Cable length (m)
	XW2Z-050AA	0.5
	XW2Z-100AA	1
	XW2Z-200AA	2
	XW2Z-500AA	5
	XW2Z-010AA	10

Wiring Diagram

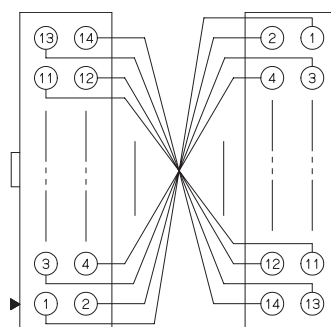

Cable Length (m)



Note: Wire the connectors 1:1 so that the connector terminal numbers coincide.

Input Device Connectors: XN2 e-CON Connectors

Sensor Connector

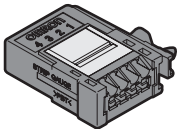
Appearance	Pins	Model
	4	XN2A-1470

Relay Connector

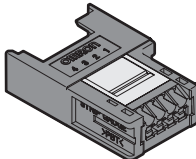
Appearance	Pins	Model
	4	XN2B-1470

Ratings and Specifications

Rated current	3 A/pin (with AWG20 wires), 2 A/pin (with AWG22 wires), 1 A/pin (with AWG24 wires), 0.5 A/pin (with AWG26 or AWG28 wires)
Rated voltage	32 VDC
Contact resistance	30 mΩ max. (at 20 mV, 100 mA max.)
Insulation resistance	10 ³ MΩ min. (at 500 V DC)
Dielectric strength	1,000 VAC for 1 min (leakage current: 1 mA max.)
Insertion durability	50 times
Ambient operating temperature	-30 to 75°C ¹
Applicable wires	0.08 to 0.5 mm ² (AWG28 to AWG20) (Outer diameter of wire must be 1.5 mm max.) ²

*1. The operating temperature range is restricted by the maximum operating temperature of the cable.

*2. Consult with your OMRON representative before using wires with a single wire diameter of 0.16 mm or less.

Connection Procedure

● Preparing Wires

Strip 7 to 8 mm of the wire insulation using the STRIP GAUGE on the Connector as a guide, and twist the wire strands together several times.

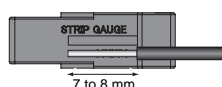

● Connecting Wires

1. Insert a flat-bladed screw driver and press the operation lever inside the operation opening until it locks open.

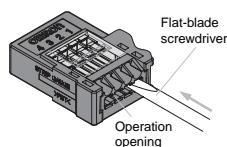

2. Insert the wire all the way to the back of the wire insertion opening. Confirm that the wire insulation has entered the wire insertion opening and that the end of the core has passed through the contact section.

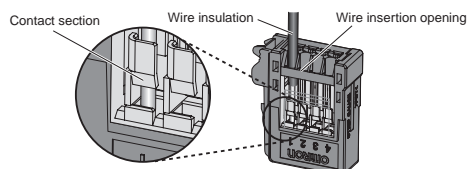

3. Insert the screwdriver in the release opening and gently press the lever until it clicks back to its original position.

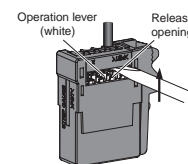

4. Confirm the following items.

- The operation level has returned to its original position.
- That the wire and wire insulation are in the proper positions, as described in step 2. (Pull on the wire lightly to be sure it is connected.)

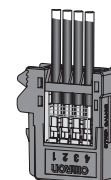

● Removing Wires

1. Insert a flat-bladed screw driver and press the operation lever inside the operation opening until it locks open and then pull out the wire.

2. Always return the operation lever to its original position after removing a wire.

If another wire is to be connected, however, it can be connected immediately without returning the operation lever first.

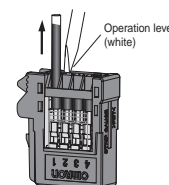

Safety Precautions

Precautions for Correct Use

● Wiring Precautions

- Do not perform wiring work, remove connectors, or connect connectors while power is being supplied. Electric shock or damage to the device may result.
- Double-check all wiring before turning ON the power supply.
- After wiring, confirm that the cable is connected.
- After wiring, route the cable so that force is not applied directly to the connections.
- Insert only one wire in each wire insertion opening. It may not be possible to remove the wires if more than one wire is inserted.
- Do not apply a current higher than the rated value. Be sure to check the rated current, which depends on the model of the cable.

● Wires for Terminal Blocks

- Do not damage the cores when stripping the insulation from them.
- Always twist stranded wires together before connecting them.
- Do not presolder wires. It may not be possible to connect them or remove them.

● Mounting to and Removing from DIN Track

Mounting Procedure



- Hook the Unit on the DIN Track.
- Press the Unit onto the DIN Track to secure it.

Removal Procedure



- Insert a flat-blade screwdriver into the DIN Track lock.
- Move the screwdriver like a lever to free the lock.

● Applicable Ferrules

- Use ferrules of the lengths and thicknesses specified below. If other lengths or thicknesses are used, connection may not be possible or it may not be possible to insert or remove the posts.
- Ferrule Dimensions

Square ferrules	Dimension A (width)	2.7 mm max.	The cross-sectional area after crimping must be 4.8 mm ² or less
	Dimension B (height)	2 mm max.	
Round ferrules	Dimension C (diameter)	2 mm dia. max. (after crimping)	

Square Ferrules

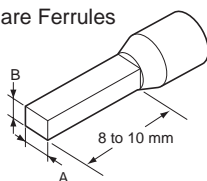

Round Ferrules

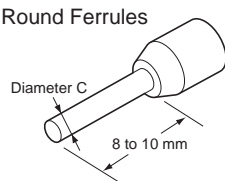

● Recommended Ferrules for XW2R-P□□ Connectors

Ferrule type	Manufacturer	Size	Ferrule model	Recommended crimp tool
Square ferrules	Phoenix Contact	AWG24	AI0.25-8□□	CRIMFOX6
		AWG22	AI0.34-8TQ	
		AWG20	AI0.5-10WH AI0.5-8WH	
		AWG18	AI0.75-10GY AI0.75-8GY	
		AWG16	AI1.5-10BK	
	Weidmueller	AWG24	H0.25/12	PZ6 roto
		AWG22	H0.34/12	
		AWG20	H0.5/14	
		AWG18	H0.75/14	
		AWG16	H1.5/14	
Round ferrules	Nichifu	AWG22-AWG16	TGV TC-1.25-11	NH11 NH32 NH65

Note: Note: □□ is replaced by the color code. (Example: YE = yellow)

● Connecting Spring cramp Terminals

Using Ferrules

How to insert wire



How to release wire



Using Stripped Wires

Inserting and Removing Wires



Inserting Wires

- Press the a flat-blade screwdriver diagonally into the release hole.

Press at an angle of 10° to 15°.

If you press in the screwdriver correctly, you will feel the spring in the release hole.

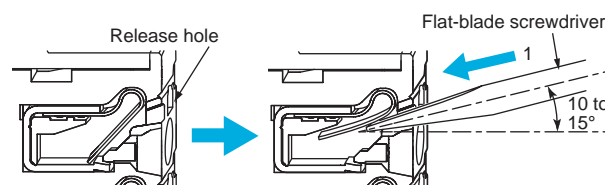

2) Leave the flat-blade screwdriver pressed into the release hole and insert the twisted stranded wires or the solid wire into the terminal hole.

Insert the twisted wire or the solid wire until the stripped portion is no longer visible to prevent shorting.

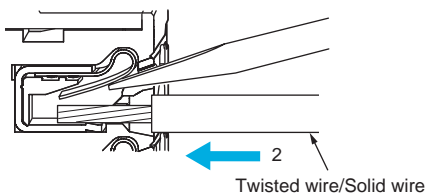

3) Remove the flat-blade screwdriver from the release hole.

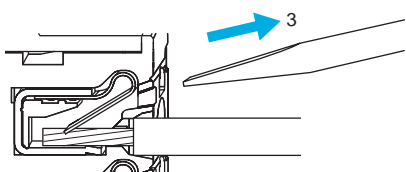

Removing Wires

1) Press the flat-blade screwdriver diagonally into the release hole.

Press at an angle of 10° to 15°.

If you press in the screwdriver correctly, you will feel the spring in the release hole.

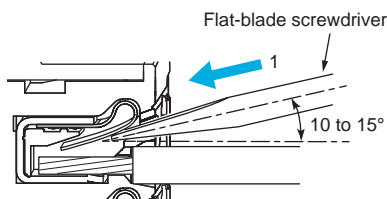

2) Leave the flat-blade screwdriver pressed into the release hole and pull out the wire.

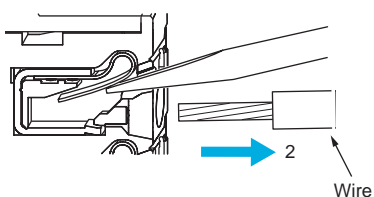

3) Remove the flat-blade screwdriver from the release hole.

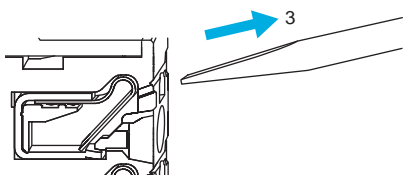

Precautions for Safe Use

- Do not press the flat-blade screwdriver straight into the release hole. Doing so may break the terminal block.

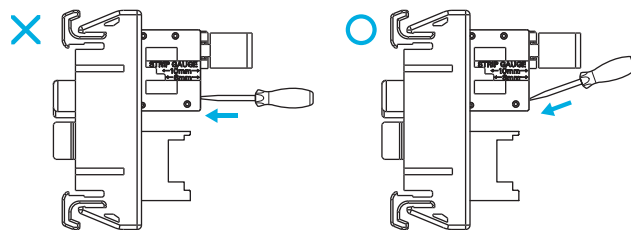

- When you insert a flat-blade screwdriver into a release hole, press it down with a force of 30 N max. Applying excessive force may damage the terminal block.
- Do not tilt or twist the flat-blade screwdriver while it is pressed into the release hole. Doing so may break the terminal block.

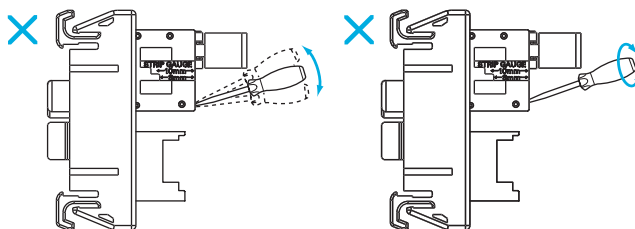

- Make sure that all wiring is correct.
- Do not bend the cable forcibly. Doing so may sever the cable.

Use tool

- Select a use tool from following table.

Use tool	Specialized tool and dimension
Flat-blade screwdriver	Model XW4Z-00B Head of screwdriver Is 0.4 × 2.5mm max.

Flat-blade screwdriver

Models
XW4Z-00B

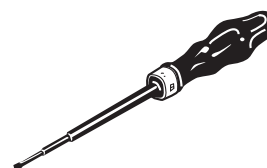

Terms and Conditions Agreement

Read and understand this catalog.

Please read and understand this catalog before purchasing the products. Please consult your OMRON representative if you have any questions or comments.

Warranties.

(a) Exclusive Warranty. Omron's exclusive warranty is that the Products will be free from defects in materials and workmanship for a period of twelve months from the date of sale by Omron (or such other period expressed in writing by Omron). Omron disclaims all other warranties, express or implied.

(b) Limitations. OMRON MAKES NO WARRANTY OR REPRESENTATION, EXPRESS OR IMPLIED, ABOUT NON-INFRINGEMENT, MERCHANTABILITY OR FITNESS FOR A PARTICULAR PURPOSE OF THE PRODUCTS. BUYER ACKNOWLEDGES THAT IT ALONE HAS DETERMINED THAT THE PRODUCTS WILL SUITABLY MEET THE REQUIREMENTS OF THEIR INTENDED USE.

Omron further disclaims all warranties and responsibility of any type for claims or expenses based on infringement by the Products or otherwise of any intellectual property right. (c) Buyer Remedy. Omron's sole obligation hereunder shall be, at Omron's election, to (i) replace (in the form originally shipped with Buyer responsible for labor charges for removal or replacement thereof) the non-complying Product, (ii) repair the non-complying Product, or (iii) repay or credit Buyer an amount equal to the purchase price of the non-complying Product; provided that in no event shall Omron be responsible for warranty, repair, indemnity or any other claims or expenses regarding the Products unless Omron's analysis confirms that the Products were properly handled, stored, installed and maintained and not subject to contamination, abuse, misuse or inappropriate modification. Return of any Products by Buyer must be approved in writing by Omron before shipment. Omron Companies shall not be liable for the suitability or unsuitability or the results from the use of Products in combination with any electrical or electronic components, circuits, system assemblies or any other materials or substances or environments. Any advice, recommendations or information given orally or in writing, are not to be construed as an amendment or addition to the above warranty.

See <http://www.omron.com/global/> or contact your Omron representative for published information.

Limitation on Liability; Etc.

OMRON COMPANIES SHALL NOT BE LIABLE FOR SPECIAL, INDIRECT, INCIDENTAL, OR CONSEQUENTIAL DAMAGES, LOSS OF PROFITS OR PRODUCTION OR COMMERCIAL LOSS IN ANY WAY CONNECTED WITH THE PRODUCTS, WHETHER SUCH CLAIM IS BASED IN CONTRACT, WARRANTY, NEGLIGENCE OR STRICT LIABILITY.

Further, in no event shall liability of Omron Companies exceed the individual price of the Product on which liability is asserted.

Suitability of Use.

Omron Companies shall not be responsible for conformity with any standards, codes or regulations which apply to the combination of the Product in the Buyer's application or use of the Product. At Buyer's request, Omron will provide applicable third party certification documents identifying ratings and limitations of use which apply to the Product. This information by itself is not sufficient for a complete determination of the suitability of the Product in combination with the end product, machine, system, or other application or use. Buyer shall be solely responsible for determining appropriateness of the particular Product with respect to Buyer's application, product or system. Buyer shall take application responsibility in all cases.

NEVER USE THE PRODUCT FOR AN APPLICATION INVOLVING SERIOUS RISK TO LIFE OR PROPERTY OR IN LARGE QUANTITIES WITHOUT ENSURING THAT THE SYSTEM AS A WHOLE HAS BEEN DESIGNED TO ADDRESS THE RISKS, AND THAT THE OMRON PRODUCT(S) IS PROPERLY RATED AND INSTALLED FOR THE INTENDED USE WITHIN THE OVERALL EQUIPMENT OR SYSTEM.

Programmable Products.

Omron Companies shall not be responsible for the user's programming of a programmable Product, or any consequence thereof.

Performance Data.

Data presented in Omron Company websites, catalogs and other materials is provided as a guide for the user in determining suitability and does not constitute a warranty. It may represent the result of Omron's test conditions, and the user must correlate it to actual application requirements. Actual performance is subject to the Omron's Warranty and Limitations of Liability.

Change in Specifications.

Product specifications and accessories may be changed at any time based on improvements and other reasons. It is our practice to change part numbers when published ratings or features are changed, or when significant construction changes are made. However, some specifications of the Product may be changed without any notice. When in doubt, special part numbers may be assigned to fix or establish key specifications for your application. Please consult with your Omron's representative at any time to confirm actual specifications of purchased Product.

Errors and Omissions.

Information presented by Omron Companies has been checked and is believed to be accurate; however, no responsibility is assumed for clerical, typographical or proofreading errors or omissions.

2013.9

In the interest of product improvement, specifications are subject to change without notice.

OMRON Corporation
Industrial Automation Company

<http://www.ia.omron.com/>

(c)Copyright OMRON Corporation 2013 All Right Reserved.