

Photomicrosensor (Transmissive) EE-SX1235A-P2

■ Dimensions

Note: All units are in millimeters unless otherwise indicated.

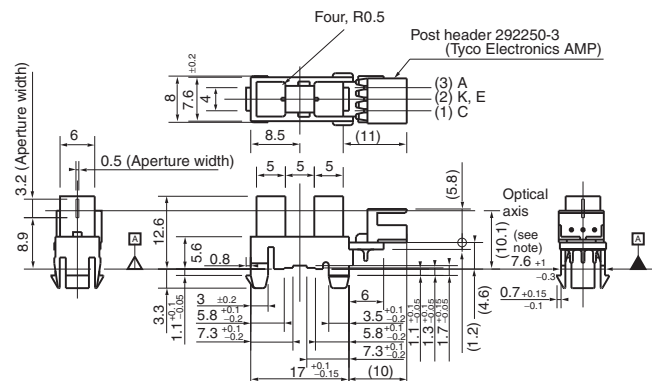

Internal Circuit

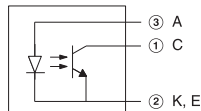

Note: The asterisked dimension is specified by datum A only.

Unless otherwise specified, the tolerances are as shown below.

Dimensions	Tolerance
3 mm max.	±0.3
3 < mm ≤ 6	±0.375
6 < mm ≤ 10	±0.45
10 < mm ≤ 18	±0.55
18 < mm ≤ 30	±0.65

Terminal No.	Name
A	Anode
C	Collector
K, E	Cathode, Emitter

Recommended Mating Connectors:
Tyco Electronics AMP 173977-3 (press-fit connector)
175778-3 (crimp connector)
179228-3 (crimp connector)

■ Features

- Snap-in mounting model.
- Mounts to 1.0-, 1.2- and 1.6-mm-thick PCBs.
- High resolution with a 0.5-mm-wide aperture.
- 5-mm-wide slot.
- Connects to Tyco Electronics AMP's CT-series connectors.
- RoHS Compliant.

■ Absolute Maximum Ratings (Ta = 25°C)

Item	Symbol	Rated value
Emitter	Forward current	I_F 50 mA (see note)
	Pulse forward current	I_{FP} ---
	Reverse voltage	V_R 4 V
Detector	Collector–Emitter voltage	V_{CEO} 30 V
	Emitter–Collector voltage	V_{ECO} 5 V
	Collector current	I_C 20 mA
	Collector dissipation	P_C 100 mW (see note)
Ambient temperature	Operating	T_{opr} -25°C to 95°C
	Storage	T_{stg} -40°C to 100°C
Soldering temperature	T_{sol}	---

Note: Refer to the temperature rating chart if the ambient temperature exceeds 25°C.

■ Ordering Information

Description	Model
Photomicrosensor (transmissive)	EE-SX1235A-P2

■ Electrical and Optical Characteristics (Ta = 25°C)

Item	Symbol	Value	Condition
Emitter	Forward voltage	V_F 1.2 V typ., 1.5 V max.	$I_F = 30$ mA
	Reverse current	I_R 0.01 μ A typ., 10 μ A max.	$V_R = 4$ V
	Peak emission wavelength	λ_P 940 nm typ.	$I_F = 30$ mA
Detector	Light current	I_L 0.6 mA min., 14 mA max.	$I_F = 20$ mA, $V_{CE} = 5$ V
	Dark current	I_D 200 nA max.	$V_{CE} = 10$ V, 0 lx
	Leakage current	I_{LEAK} ---	---
	Collector–Emitter saturated voltage	$V_{CE(sat)}$ 0.1 V typ., 0.4 V max.	$I_F = 20$ mA, $I_L = 0.3$ mA
	Peak spectral sensitivity wavelength	λ_P 850 nm typ.	$V_{CE} = 5$ V
Rising time	t_r	8 μ s typ.	$V_{CC} = 5$ V, $R_L = 100 \Omega$, $I_L = 1$ mA
Falling time	t_f	8 μ s typ.	$V_{CC} = 5$ V, $R_L = 100 \Omega$, $I_L = 1$ mA

■ Engineering Data

Forward Current vs. Collector Dissipation Temperature Rating

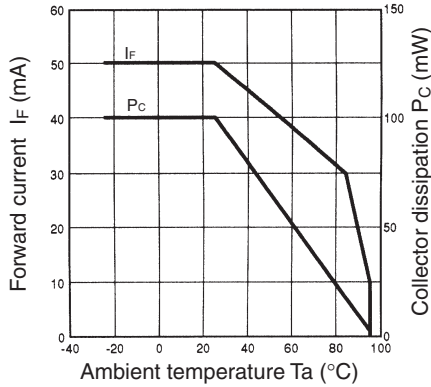

Forward Current vs. Forward Voltage Characteristics (Typical)

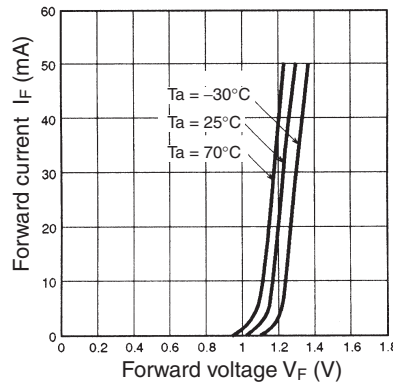

Light Current vs. Forward Current Characteristics (Typical)

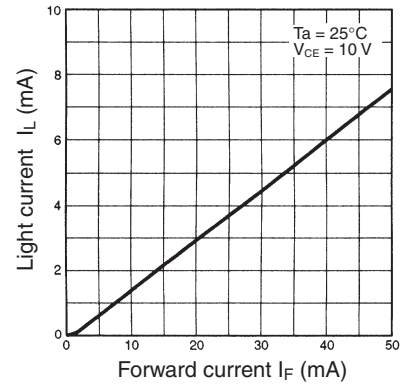

Light Current vs. Collector-Emitter Voltage Characteristics (Typical)

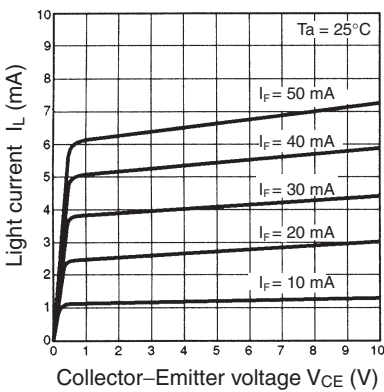

Relative Light Current vs. Ambient Temperature Characteristics (Typical)

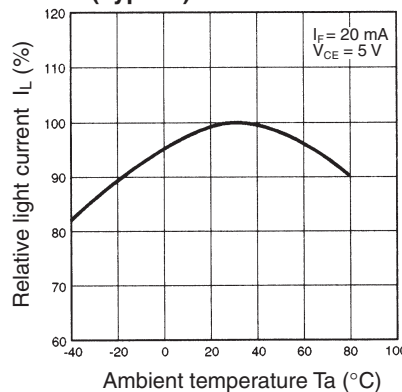

Dark Current vs. Ambient Temperature Characteristics (Typical)

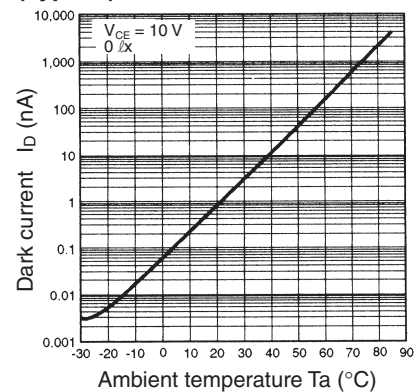

Response Time vs. Load Resistance Characteristics (Typical)

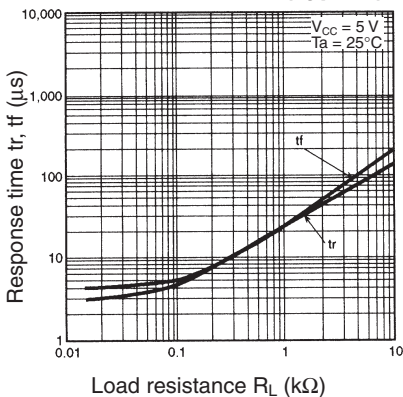

Sensing Position Characteristics (Typical)

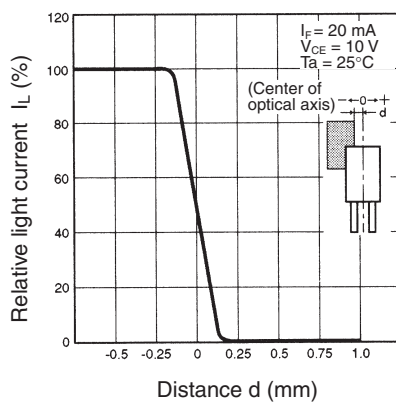

Sensing Position Characteristics (Typical)

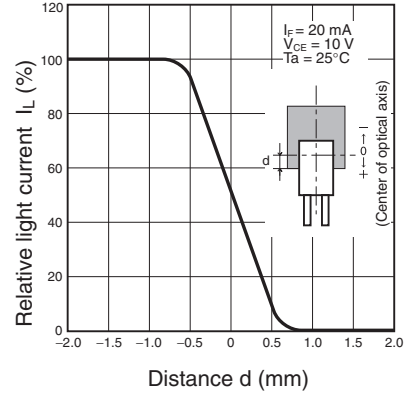

Response Time Measurement Circuit

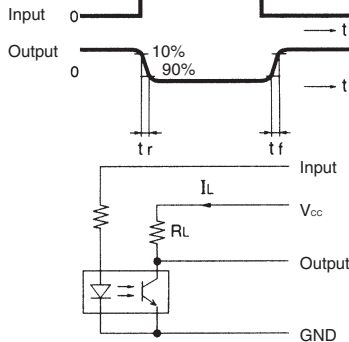

See also EE-SX4235A-P2 datasheet.

A large grid of 20 columns and 30 rows of small squares, intended for taking notes. The grid is composed of thin, light gray lines forming a uniform pattern across the page.

All sales are subject to Omron Electronic Components LLC standard terms and conditions of sale, which can be found at http://www.components.omron.com/components/web/webfiles.nsf/sales_terms.html

ALL DIMENSIONS SHOWN ARE IN MILLIMETERS.
To convert millimeters into inches, multiply by 0.03937. To convert grams into ounces, multiply by 0.03527.

OMRON[®]

**OMRON ELECTRONIC
COMPONENTS LLC**

55 E. Commerce Drive, Suite B
Schaumburg, IL 60173

847-882-2288

OMRON ON-LINE

Global - <http://www.omron.com>

USA - <http://www.components.omron.com>