

# EE-SX3160-W11/4160-W11

## Slot/Pre-wired, Wide-width Type (Slot Width: 9.5 mm)

- Photo IC output (Two types available: Dark-ON (EE-SX3160-W11)/ Light-ON (EE-SX4160-W11))
- Featuring enhanced maintainability thanks to a removable dedicated connector
- Mounted with M3 screws
- Wire length 610 mm min. (AWG28)
- Enhanced reliability thanks to solder-less lead wire installation

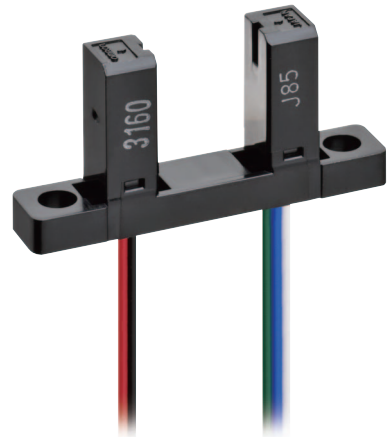

**⚠** Be sure to read *Safety Precautions* on Page 3.

**RoHS Compliant**

## Ordering Information

### Photomicrosensor

Appearance	Sensing method	Connecting method	Sensing distance	Aperture size (H × W) (mm)	Output type	Model	Minimum packing unit (Unit: pcs)
	Transmissive (slot type)	Pre-wired type	 9.5 mm (Slot width)	Both emitting side and detecting side 1.9 × 1.1	Photo IC	<b>EE-SX3160-W11</b> (Dark-ON) <b>EE-SX4160-W11</b> (Light-ON)	1

Note: Order in multiples of minimum packing unit.

## Ratings, Characteristics and Exterior Specifications

### Absolute Maximum Ratings (Ta = 25°C)

Item	Symbol	Rated value	Unit
<b>Emitter</b>			
Forward current	I <sub>F</sub>	50*	mA
Reverse voltage	V <sub>R</sub>	4	V
<b>Detector</b>			
Power supply voltage	V <sub>CC</sub>	16	V
Output voltage	V <sub>OUT</sub>	28	V
Output current	I <sub>OUT</sub>	16	mA
Permissible output dissipation	P <sub>OUT</sub>	250*	mW
Operating temperature	T <sub>opr</sub>	-25 to 75	°C
Storage temperature	T <sub>stg</sub>	-25 to 85	°C

\* Refer to the temperature rating chart if the ambient temperature exceeds 25°C.

- Note: 1. When screw mounting, use an M3 screw, spring washer, and plain washer and tighten with a torque of 0.5 N·m.  
2. Do not use the lead wire with stress applied.

### Exterior Specifications

Connecting method	Weight (g)	Material	
		Case	Wire insulator
Pre-wired type	5.05	Polycarbonate	Non-lead PVC

### Electrical and Optical Characteristics (Ta = 25°C)

Item	Symbol	Value			Unit	Condition
		MIN.	TYP.	MAX.		
<b>Emitter</b>						
Forward voltage	V <sub>F</sub>	—	1.2	1.5	V	I <sub>F</sub> = 20 mA
Reverse current	I <sub>R</sub>	—	0.01	10	μA	V <sub>R</sub> = 4 V
Peak emission wavelength	λ <sub>P</sub>	—	920	—	nm	I <sub>F</sub> = 20 mA
<b>Detector</b>						
Low-level output voltage	V <sub>OL</sub>	—	0.12	0.4	V	V <sub>CC</sub> = 4.5 to 16 V, I <sub>OL</sub> = 16 mA I <sub>F</sub> = 0 mA (EE-SX3160) I <sub>F</sub> = 10 mA (EE-SX4160)
High-level output voltage	V <sub>OH</sub>	15	—	—	V	V <sub>CC</sub> = 16 V, R <sub>L</sub> = 1 kΩ I <sub>F</sub> = 10 mA (EE-SX3160) I <sub>F</sub> = 0 mA (EE-SX4160)
Current consumption	I <sub>CC</sub>	—	3.2	10	mA	V <sub>CC</sub> = 16 V
Peak spectral sensitivity wavelength	λ <sub>P</sub>	—	870	—	nm	V <sub>CC</sub> = 4.5 to 16 V
LED current when output OFF (EE-SX3160-W11)	I <sub>FT</sub>	—	2	10	mA	V <sub>CC</sub> = 4.5 to 16 V
LED current when output ON (EE-SX4160-W11)	I <sub>FT</sub>	—	2	10	mA	V <sub>CC</sub> = 4.5 to 16 V
Hysteresis	ΔH	—	15	—	%	V <sub>CC</sub> = 4.5 to 16 V*1
Response frequency	f	3	—	—	kHz	V <sub>CC</sub> = 4.5 to 16 V*2 I <sub>F</sub> = 15 mA, I <sub>OL</sub> = 16 mA
Response delay time	t <sub>PLH</sub> (t <sub>PHL</sub> )	—	3	—	μs	V <sub>CC</sub> = 4.5 to 16 V*3 I <sub>F</sub> = 15 mA, I <sub>OL</sub> = 16 mA
Response delay time	t <sub>PHL</sub> (t <sub>PLH</sub> )	—	20	—	μs	V <sub>CC</sub> = 4.5 to 16 V*3 I <sub>F</sub> = 15 mA, I <sub>OL</sub> = 16 mA

- \*1. Hysteresis is the difference in LED current between two states when the output state is inverted and expressed as a percentage.
- \*2. The value of the response frequency is measured by rotating the disk as shown below.

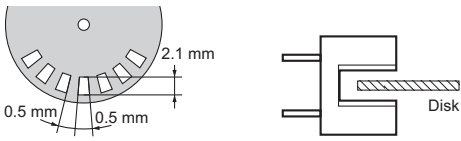

- \*3. Refer to the following diagrams for definitions of response delay time. ( $t_{PHL}$  and  $t_{PLH}$ ) are applicable to EE-SX4160

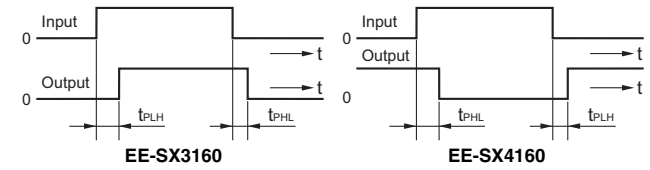

**Engineering Data (Reference Value)** Note: Values in parentheses are for EE-SX4160

**Fig 1. Forward Current vs. Temperature**

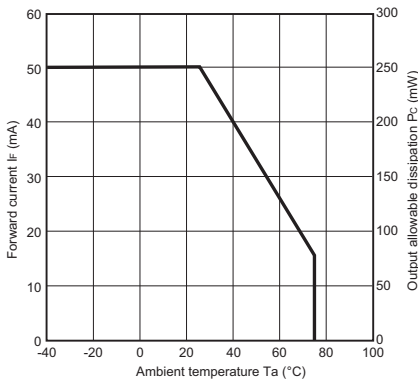

**Fig 2. Forward Current vs. Forward Voltage Characteristics (Typical)**

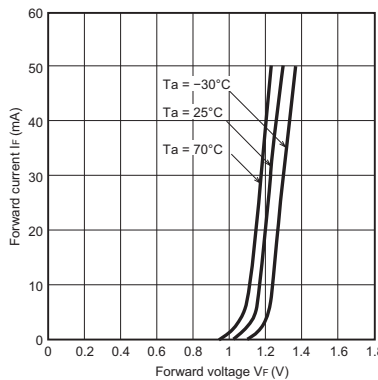

**Fig 3. LED Current When Output ON (OFF) vs. Power Supply Voltage Characteristics (Typical)**

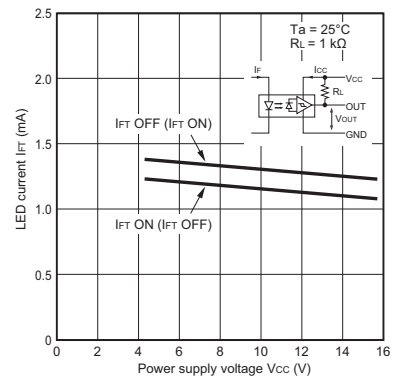

**Fig 4. LED Current When Output ON (OFF) vs. Ambient Temperature Characteristics (Typical)**

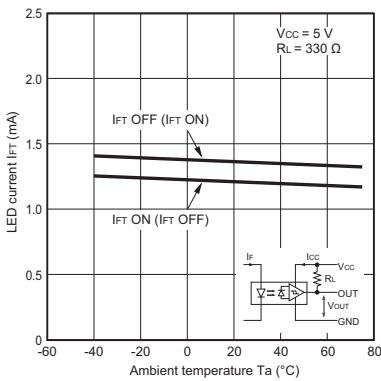

**Fig 5. Low-level Output Voltage vs. Output Current Characteristics (Typical)**

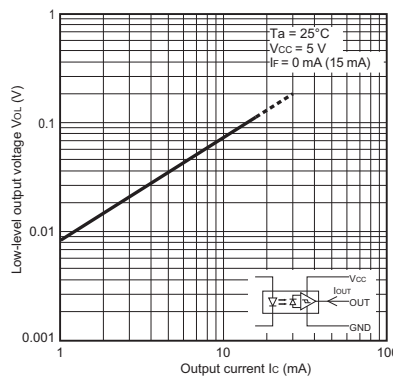

**Fig 6. Low-level Output Voltage vs. Ambient Temperature Characteristics (Typical)**

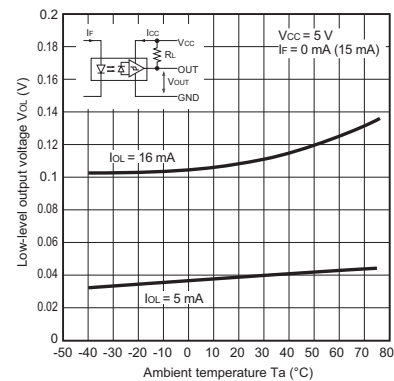

**Fig 7. Current Consumption vs. Power Supply Voltage Characteristics (Typical)**

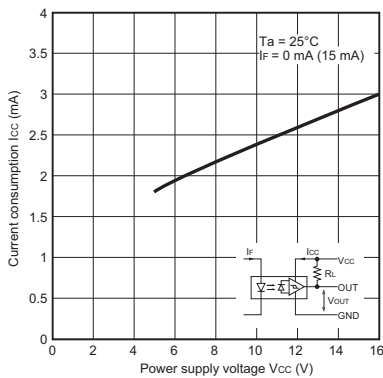

**Fig 8. Response Delay Time vs. Forward Current Characteristics (Typical)**

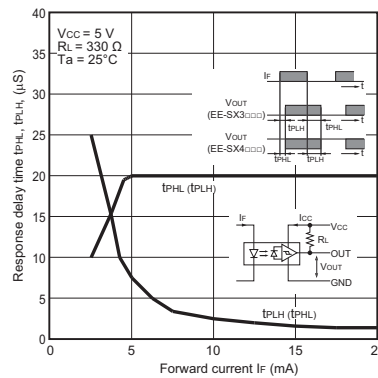

**Fig 9. Repeated Sensing Position Characteristics (Typical)**

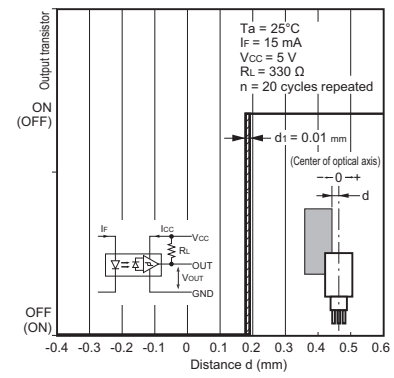

## Safety Precautions

To ensure safe operation, be sure to read and follow the Instruction Manual provided with the Sensor.

### CAUTION

This product is not designed or rated for ensuring safety of persons either directly or indirectly. Do not use it for such purposes.



### Precautions for Safe Use

**Do not use the product with a voltage or current that exceeds the rated range.**

Applying a voltage or current that is higher than the rated range may result in explosion or fire.

**Do not miswire such as the polarity of the power supply voltage.**

Otherwise the product may be damaged or it may burn.

**Do not short-circuit the load.**

Otherwise explosion or burning may occur.

**This product does not resist water. Do not use the product in places where water or oil may be sprayed onto the product.**

### Precautions for Correct Use

**Do not use the product in atmospheres or environments that exceed product ratings. When using the sensor on moving parts, secure the pull out portion of the cord so that it is not subjected to direct stress.**

**Do not perform cord wiring when power supply voltage is applied. Doing so may result in breakage.**

**Dispose of this product as industrial waste.**

## Dimensions and Internal Circuit

(Unit: mm)

### Photomicrosensor

EE-SX3160-W11  
EE-SX4160-W11

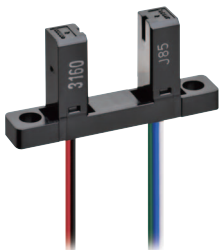

Aperture size (H x W)

Emitter	Detector
1.9 x 1.1	1.9 x 1.1

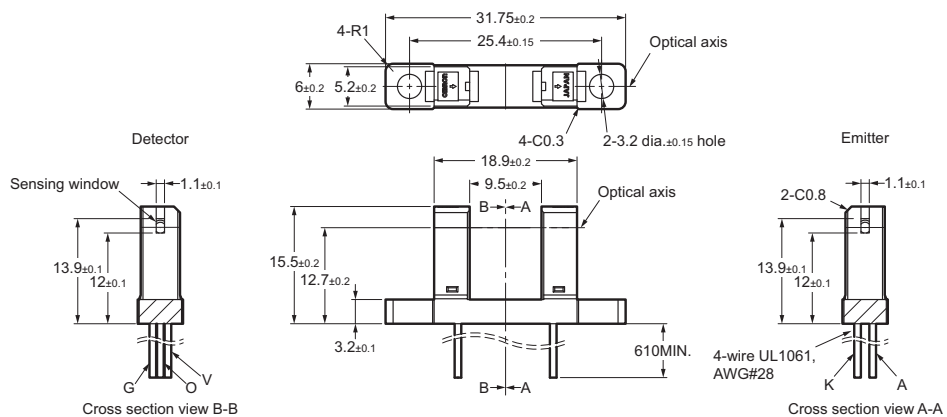

Internal circuit

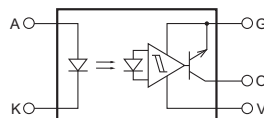

Unless otherwise specified, the tolerances are as shown below.

Terminal No.	Color	Name
A	Red	Anode
K	Black	Cathode
V	White	Power supply (Vcc)
O	Blue	Output (OUT)
G	Green	Ground (GND)

Dimensions	Tolerance
3 mm max.	±0.3
3 < mm ≤ 6	±0.375
6 < mm ≤ 10	±0.45
10 < mm ≤ 18	±0.55
18 < mm ≤ 30	±0.65

Please check each region's Terms & Conditions by region website.

---

## **OMRON Corporation**

**Electronic and Mechanical Components Company**

### **Regional Contact**

#### **Americas**

<https://www.components.omron.com/>

#### **Asia-Pacific**

<https://ecb.omron.com.sg/>

#### **Korea**

<https://www.omron-ecb.co.kr/>

#### **Europe**

<http://components.omron.eu/>

#### **China**

<https://www.ecb.omron.com.cn/>

#### **Japan**

<https://www.omron.co.jp/ecb/>