

Photomicrosensor (Transmissive)

EE-SX1350

Compact Slot / SMD Type (Slot width: 5 mm)

- Unique 5 mm Slot width.
- PCB surface mounting type.
- High resolution with a 0.5-mm-wide aperture.

 Be sure to read *Safety Precautions* on page 3.



Ordering Information

Photomicrosensor

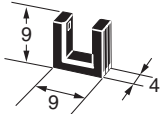
Appearance	Sensing method	Connecting method	Sensing distance	Aperture size (H × W) (mm)	Output type	Model
	Transmissive (slot type)	SMT	5 mm (slot width)	Emitter 1.4 × 1.4 Detector 1.4 × 0.5	Phototransistor	EE-SX1350

Ratings, Characteristics and Exterior Specifications

Absolute Maximum Ratings (Ta = 25°C)

Item	Symbol	Rated value	Unit	Remarks
Emitter				
Forward current	I _F	30	mA	--- *1
Pulse forward current	I _{FP}	100	mA	Duty ratio: 1% Puls width: 0.1 ms
Reverse voltage	V _R	4	V	---
Detector				
Collector-Emitter voltage	V _{CEO}	12	V	---
Emitter-Collector voltage	V _{ECO}	5	V	---
Collector current	I _C	20	mA	---
Collector dissipation	P _C	50	mW	--- *1
Operating temperature	T _{opr}	-30 to 85	°C	--- *1
Storage temperature	T _{stg}	-40 to 100	°C	--- *1
Reflow soldering temperature	T _{sol}	255	°C	10 sec. max. *2

*1. Continuous Forward Current and Collector Power Dissipation must be derated complying. The product should be used without freezing or condensation.

*2. In case of reflow soldering, conditions which are shown at the temperature profile should be kept.

Exterior Specifications

Connecting method	Weight (g)	Material
		Case
SMT	0.3	PPS

Electrical and Optical Characteristics (Ta = 25°C)

Item	Symbol	Value			Unit	Condition
		MIN.	TYP.	MAX.		
Emitter						
Forward voltage	V _F	---	1.2	1.5	V	I _F = 30 mA
Reverse current	I _R	---	0.01	10	μA	V _R = 4 V
Peak emission wavelength	λ _P	---	940	---	nm	I _F = 20 mA
Detector						
Light current	I _L	0.4	---	4	mA	I _F = 20 mA, V _{CE} = 10 V
Dark current	I _D	---	10	200	nA	V _{CE} = 10 V, 0 lux
Collector-Emitter saturated voltage	V _{CE (sat)}	---	0.1	0.4	V	I _F = 20 mA, I _L = 0.1 mA
Peak spectral sensitivity wavelength	λ _P	---	900	---	nm	V _{CE} = 5 V
Rising time	t _r	---	11	---	μs	V _{CC} = 5 V, R _L = 100 Ω, I _L = 1 mA *
Falling time	t _f	---	14	---	μs	V _{CC} = 5 V, R _L = 100 Ω, I _L = 1 mA *

* Refer to the following timing diagram for t_r and t_f.

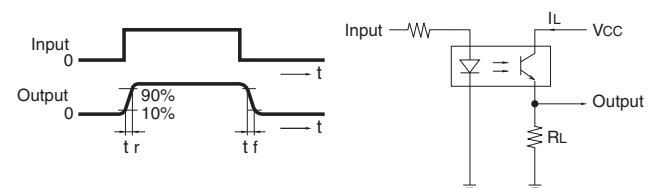

Engineering Data (Reference value)

Fig 1. Forward Current vs. Collector Dissipation Temperature Rating

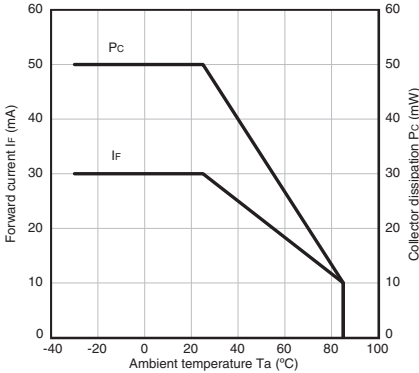

Fig 2. Forward Current vs. Forward Voltage Characteristics (Typical)

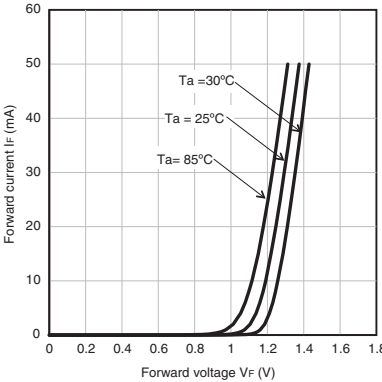

Fig 3. Light Current vs. Forward Current Characteristics (Typical)

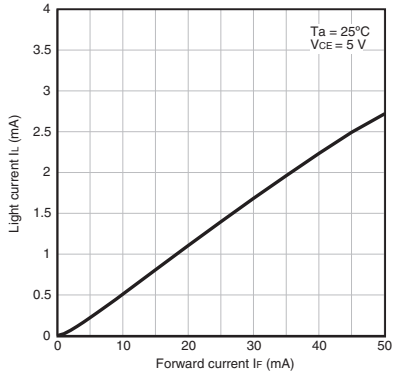

Fig 4. Light Current vs. Collector-Emitter Voltage Characteristics (Typical)

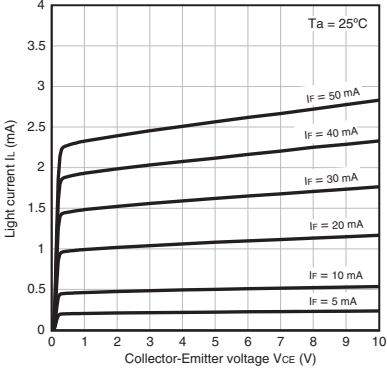

Fig 5. Relative Light Current vs. Ambient Temperature Characteristics (Typical)

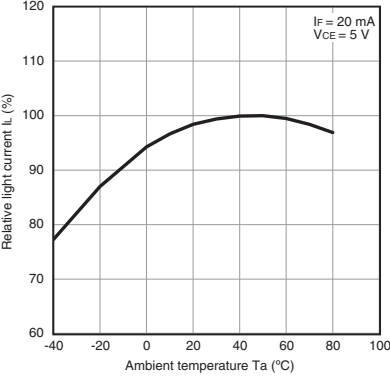

Fig 6. Dark Current vs. Ambient Temperature Characteristics (Typical)

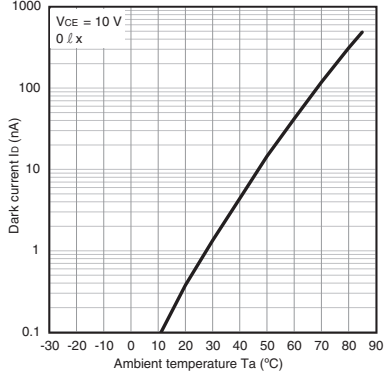

Fig 7. Response Time vs. Load Resistance Characteristics (Typical)

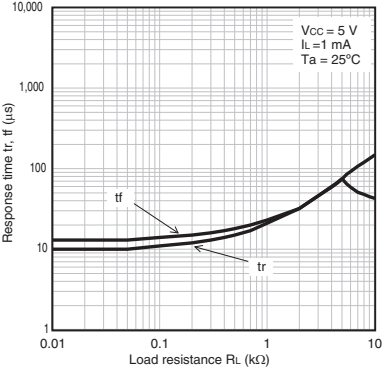

Fig 8. Sensing Position Characteristics (Typical)

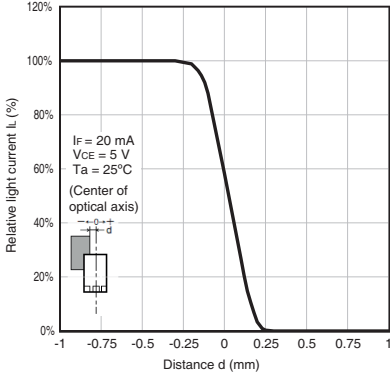
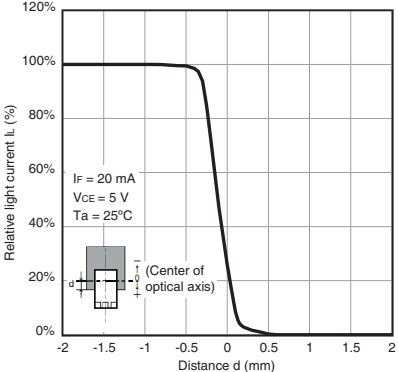
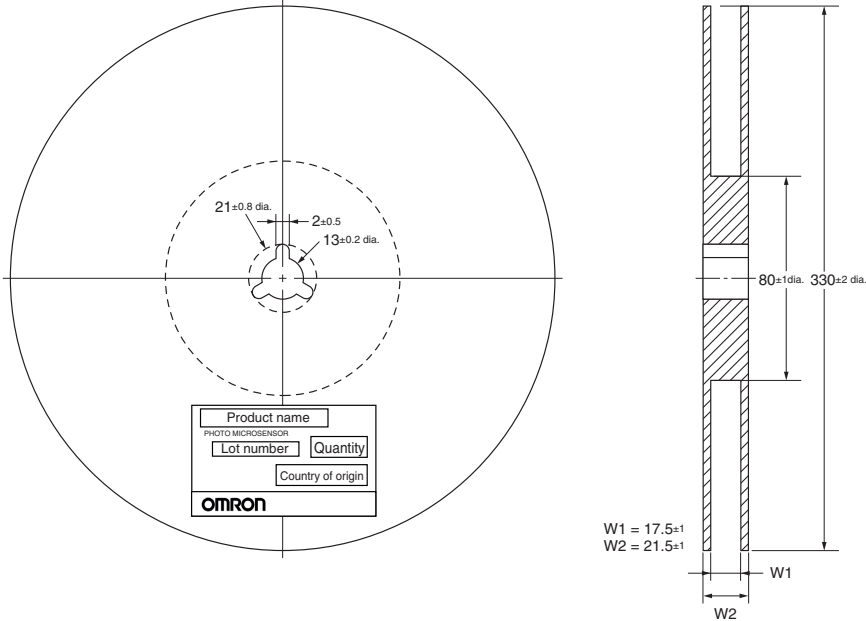

Fig 9. Sensing Position Characteristics (Typical)



Tape and Reel

Reel (Unit: mm) *



Tape (Unit: mm)

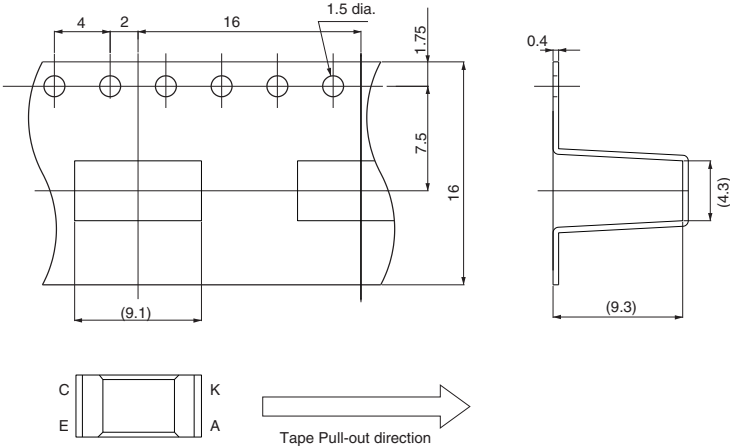

Note: Direction of product packing is upper figure.

Tape quantity

- 400 pcs./reel
- 50 pcs./pack *
- * EE-SX1350-1 (50 pcs./pack) has no reel, only tape is attached.

Soldering Information

Reflow soldering : Temperature profile

1. The reflow soldering can be implemented in two times complying with the following diagram.
All the temperatures in the product must be within the diagram.
2. The recommended thickness of the metal mask for screen printing is between 0.2 and 0.25 mm.

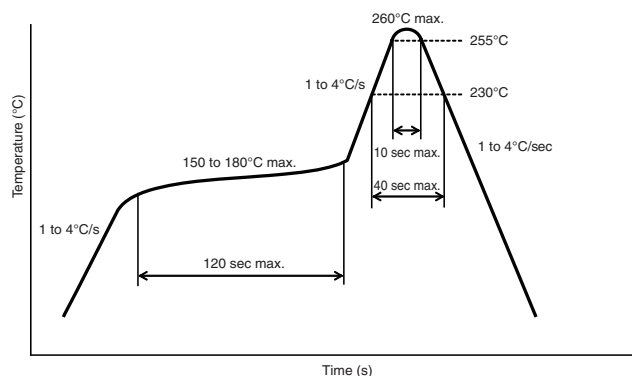

Manual soldering

The manual soldering should not be applied to the products, otherwise the housing may be deformed and/or the Au plating may be peeled off by heat.

Other notes

The use of infrared lamp causes the temperature at the resin to rise particularly too high.

All the temperatures in the product must be within the above diagram. Do not immerse the resin part into the solder. Even if within the above temperature diagram, there is a possibility that the gold wire in the products is broken in case that the deformation of PC board gives stress to the products.

Please confirm the conditions (including material and method of flux and cleaning) of the reflow soldering fully by actual solder reflow machine prior to the mass production use.

Storage

Storage conditions

To protect the product from the effects of humidity until the package is opened, dry-box storage is recommended. If this is not possible, store the product under the following conditions:

- Temperature: 10 to 30 °C
- Humidity: 60% RH max.

Treatment after open

1. Reflow soldering must be done within 48 hours stored at the conditions of humidity 60% RH or less and temperature 10 to 30°C.
2. If the product must be stored after it is unpacked, store it in a dry box or reseal it in a moisture-proof package with desiccant at a temperature of 10 to 30°C and a humidity of 60% RH or less. Even then, mount the product within one week.

Baking

In case that it could not carry out the above treatment, it is able to mount by the following baking treatment. However baking treatment shall be limited only 1 time.

- Recommended conditions: 60°C for 24 to 48 hours (reeled one)
- 100°C for 8 to 24 hours (loose one)

- Application examples provided in this document are for reference only. In actual applications, confirm equipment functions and safety before using the product.
- Consult your OMRON representative before using the product under conditions which are not described in the manual or applying the product to nuclear control systems, railroad systems, aviation systems, vehicles, combustion systems, medical equipment, amusement machines, safety equipment, and other systems or equipment that may have a serious influence on lives and property if used improperly. Make sure that the ratings and performance characteristics of the product provide a margin of safety for the system or equipment, and be sure to provide the system or equipment with double safety mechanisms.

Note: Do not use this document to operate the Unit.