

# G3VM-□□H□

MOS FET Relays SOP 6-pin, General-purpose Type

## General-purpose MOS FET Relays in SOP 6-pin packages for a wide range of applications

- Contact form: 1a (SPST-NO) or 1b (SPST-NC)
- Load voltage: 60 V, 200 V, 350 V, or 400 V

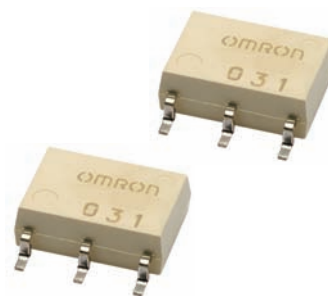

RoHS Compliant

Note: The actual product is marked differently from the image shown here.

### Application Examples

- Semiconductor test equipment
- Security equipment
- Amusement equipment
- Communication equipment
- Industrial equipment
- Test & Measurement equipment
- Power circuit

### Package

(Unit : mm, Average)

SOP 6-pin

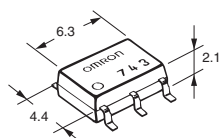

Note: The actual product is marked differently from the image shown here.

### Model Number Legend

G3VM-□□□□  
1 2 3 4

#### 1. Load Voltage

6 : 60 V  
20 : 200 V  
35 : 350 V  
40 : 400 V

#### 2. Contact form

1 : 1a (SPST-NO)  
3 : 1b (SPST-NC)

#### 3. Package

H : SOP 6-pin

#### 4. Other informations

When specifications overlap, serial code is added in the recorded order.

### Ordering Information

Package	Contact form	Terminals	Load voltage (peak value) *	Continuous load current (peak value) *		Stick packaging		Tape packaging	
				Connection A, B	Connection C	Model	Minimum package quantity	Model	Minimum package quantity
SOP6	1a (SPST-NO)	Surface-mounting Terminals	60 V	400 mA	800 mA	G3VM-61H1	75 pcs.	G3VM-61H1(TR)	2,500 pcs.
			200 V	200 mA	400 mA	G3VM-201H1		G3VM-201H1(TR)	
	350 V		110 mA	220 mA	G3VM-351H	G3VM-351H(TR)			
			120 mA	240 mA	G3VM-353H	G3VM-353H(TR)			
	400 V				G3VM-401H	G3VM-401H(TR)			

\* The AC peak and DC value are given for the load voltage and continuous load current.

Note: To order tape packaging for Relays with surface-mounting terminals, add "(TR)" to the end of the model number.

## ■ Absolute Maximum Ratings (Ta = 25°C)

Item		Symbol	G3VM-61H1	G3VM-201H1	G3VM-351H	G3VM-353H	G3VM-401H	Unit	Measurement conditions	
Input	LED forward current	$I_F$	50						mA	
	LED forward current reduction rate	$\Delta I_F/^\circ\text{C}$	-0.5						mA/°C	Ta ≥ 25°C
	LED reverse voltage	$V_R$	5						V	
	Connection temperature	$T_J$	125						°C	
Output	Load voltage (AC peak/DC)	$V_{OFF}$	60	200	350		400		V	
	Continuous load current	Connection A	$I_o$	400	200	110	120		mA	Connection A: AC peak/DC Connection B and C: DC
		Connection B		800	400	220	240			
	Connection C									
	ON current reduction rate	Connection A	$\Delta I_o/^\circ\text{C}$	-4.0	-2.0	-1.1	-1.2		mA/°C	Ta ≥ 25°C
		Connection B		-8.0	-4.0	-2.2	-2.4			
		Connection C								
Pulse ON current	$I_{op}$	1200	600	330	360			mA	t=100 ms, Duty=1/10	
Connection temperature	$T_J$	125						°C		
Dielectric strength between I/O *	$V_{I-O}$	1500						Vrms	AC for 1 min	
Ambient operating temperature	$T_a$	-40 to +85						°C	With no icing or condensation	
Ambient storage temperature	$T_{stg}$	-55 to +125						°C		
Soldering temperature	-	260						°C	10 s	

\* The dielectric strength between the input and output was checked by applying voltage between all pins as a group on the LED side and all pins as a group on the light-receiving side.

### Connection Diagram

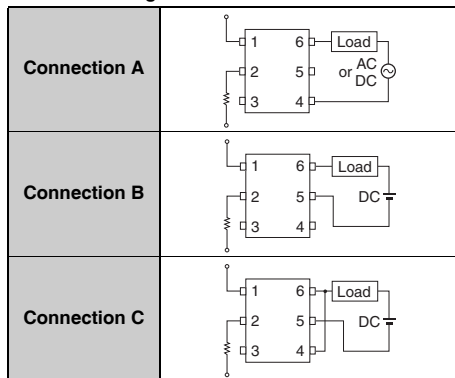

## Electrical Characteristics (Ta = 25°C)

Item		Symbol	G3VM-61H1	G3VM-201H1	G3VM-351H	G3VM-353H	G3VM-401H	Unit	Measurement conditions	
Input	LED forward voltage	V <sub>F</sub>	Minimum					1.0	V	I <sub>F</sub> =10 mA
			Typical					1.15		
			Maximum					1.3		
	Reverse current	I <sub>R</sub>	Maximum					10	μA	V <sub>R</sub> =5 V
	Capacitance between terminals	C <sub>T</sub>	Typical					30	pF	V=0, f=1 MHz
Trigger LED forward current	I <sub>FT</sub> (I <sub>FC</sub> ) *2	Typical	1.6	1				mA	G3VM-61H1/201H1/351H/401H : I <sub>o</sub> =Continuous load current ratings G3VM-353H : I <sub>OFF</sub> =10 μA	
		Maximum	3							
Release LED forward current	I <sub>FC</sub> (I <sub>FT</sub> ) *2	Minimum	0.1					mA	G3VM-61H1/201H1/351H/401H : I <sub>OFF</sub> =100 μA G3VM-353H : I <sub>o</sub> =120 mA	
Output	Maximum resistance with output ON	R <sub>ON</sub>	Typical	1	5	35 (25)	15	17	Ω	G3VM-61H1/201H1/351H/401H : I <sub>F</sub> =5 mA, I <sub>o</sub> =Continuous load current ratings Values in parentheses are for t < 1 s. G3VM-353H : I <sub>o</sub> =Continuous load current ratings
				0.5	3	28	8	11		
				0.25	1.5	14	4	6		
			Maximum	2	8	50 (35)	25	35		
				1	5	40	14	20		
				-		20	-			
Current leakage when the relay is open	I <sub>LEAK</sub>	Maximum	1					μA	G3VM-61H1/201H1/351H/401H : V <sub>OFF</sub> =Load voltage ratings G3VM-353H : V <sub>OFF</sub> =350 V, I <sub>F</sub> =5 mA	
Capacitance between terminals	C <sub>OFF</sub>	Typical	130	100	30	65	70	pF	G3VM-61H1/201H1/351H/401H : V=0, f=1 MHz G3VM-353H : V=0, f=1 MHz, I <sub>F</sub> =5 mA	
Capacitance between I/O terminals	C <sub>I-O</sub>	Typical	0.8					pF	f=1 MHz, V <sub>S</sub> =0 V	
Insulation resistance between I/O terminals	R <sub>I-O</sub>	Minimum	1000					MΩ	V <sub>I-O</sub> =500 VDC, R <sub>oH</sub> ≤60%	
		Typical	10 <sup>8</sup>							
Turn-ON time	t <sub>ON</sub>	Typical	0.8	0.6	0.3	-	0.3	ms	I <sub>F</sub> =5 mA, R <sub>L</sub> =200 Ω, V <sub>DD</sub> =20 V *1	
		Maximum	2	1.5	1					
Turn-OFF time	t <sub>OFF</sub>	Typical	0.1			-	0.1			
		Maximum	0.5	1		3	1			

\*1. Turn-ON and Turn-OFF Times

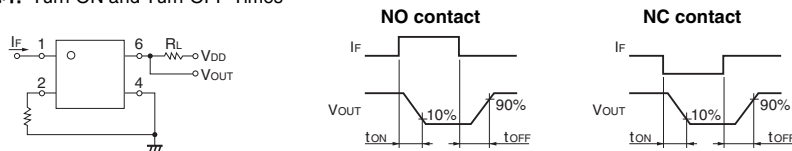

\*2. These values are for Relays with NC contacts

## Recommended Operating Conditions

For usage with high reliability, Recommended Operation Conditions is a measure that takes into account the derating of Absolute Maximum Ratings and Electrical Characteristics.

Each item on this list is an independent condition, so it is not simultaneously satisfy several conditions.

Item	Symbol	G3VM-61H1	G3VM-201H1	G3VM-351H	G3VM-353H	G3VM-401H	Unit	
Load voltage (AC peak/DC)	V <sub>DD</sub>	Maximum	48	160	280		V	
Operating LED forward current	I <sub>F</sub>	Minimum	5					mA
		Typical	7.5					
		Maximum	10	-	7.5			
Continuous load current (AC peak/DC)	I <sub>o</sub>	Maximum	400	130	100	120		
Ambient operating temperature	T <sub>a</sub>	Minimum	-20					°C
		Maximum	65	60	65			

## Spacing and Insulation

Item	Minimum	Unit
Creepage distances	4.0	mm
Clearance distances	4.0	
Internal isolation thickness	0.1	

## Engineering Data

### LED forward current vs. Ambient temperature

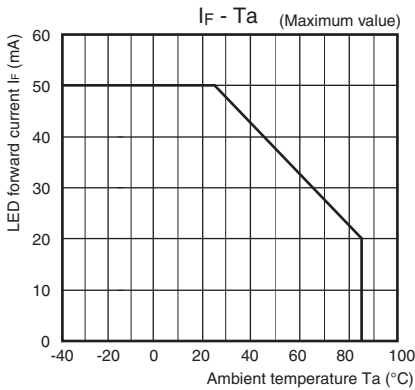

### LED forward current vs. LED forward voltage

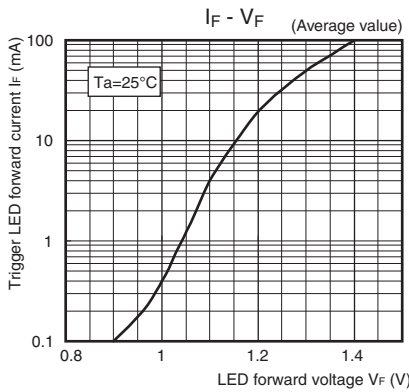

### On-state resistance vs. Ambient temperature

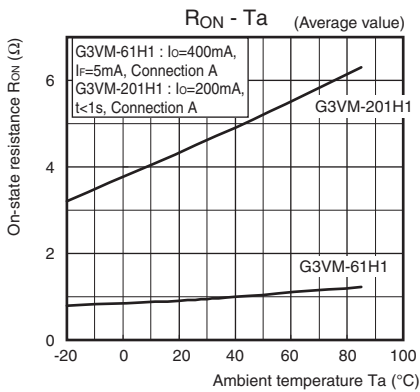

### Continuous load current vs. Ambient temperature

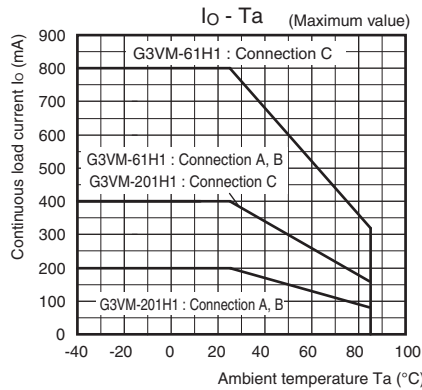

### Continuous load current vs. On-state voltage

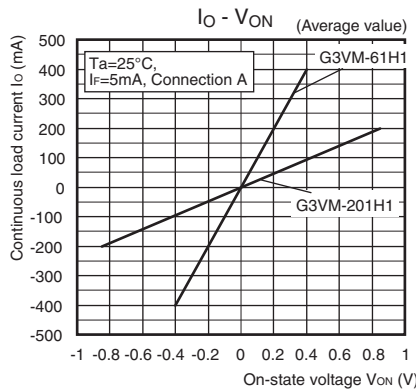

### G3VM-351H/353H/401H

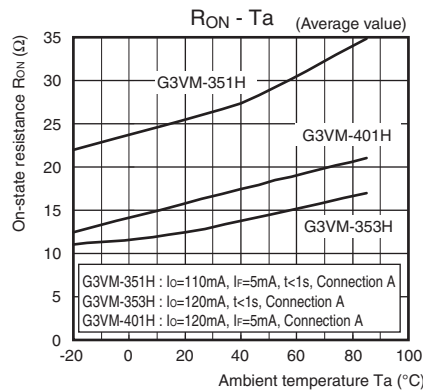

### G3VM-351H/353H/401H

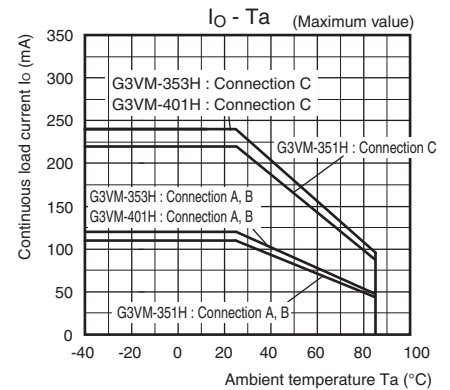

### G3VM-351H/353H/401H

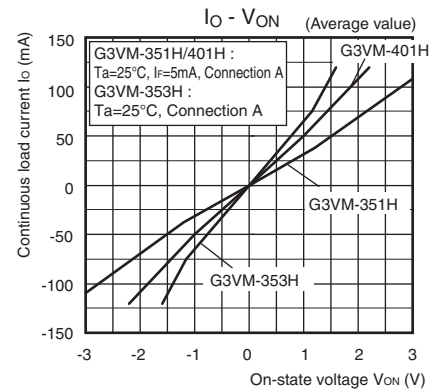

### Trigger LED forward current vs. Ambient temperature

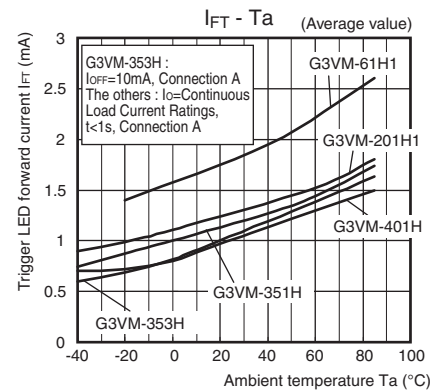

## Engineering Data

### ● Turn ON, Turn OFF time vs. LED forward current G3VM-61H1/201H1

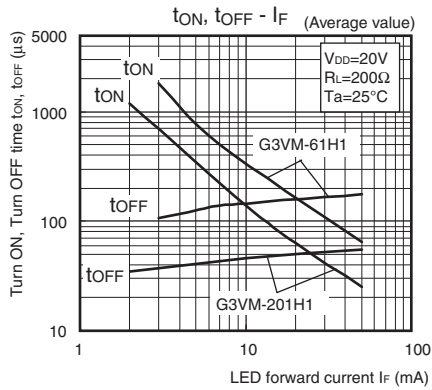

### G3VM-351H/353H/401H

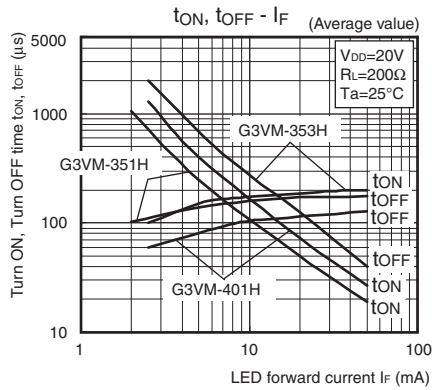

### ● Turn ON, Turn OFF time vs. Ambient temperature G3VM-61H1/201H1

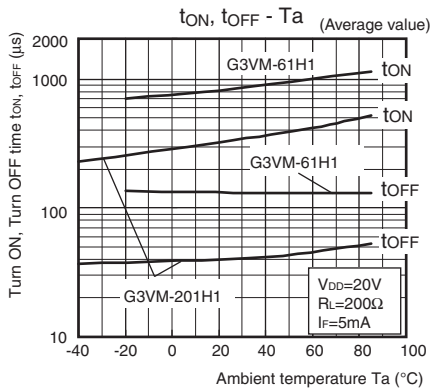

### G3VM-351H/353H/401H

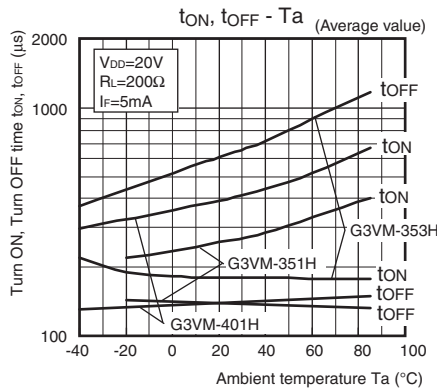

### ● Current leakage vs. Ambient temperature

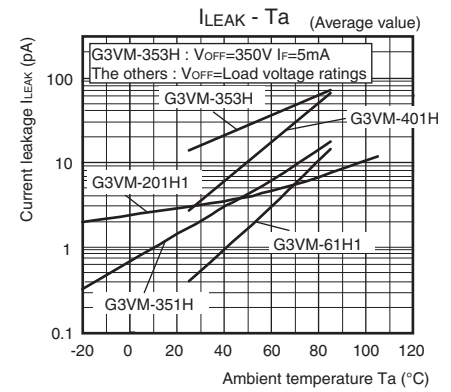

SOP

G3VM-□H□

## ■ Appearance / Terminal Arrangement / Internal Connections

### ● Appearance

#### SOP (Small Outline Package)

SOP 6-pin

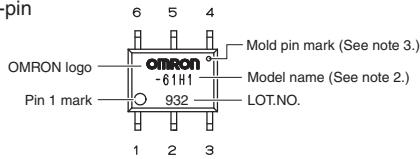

- Note: 1.** The actual product is marked differently from the image shown here.
- Note: 2.** "G3VM" does not appear in the model number on the Relay.
- Note: 3.** The indentation in the corner diagonally opposite from the pin 1 mark is from a pin on the mold.

### ● Terminal Arrangement/Internal Connections (Top View)

G3VM-61H1/201H1/351H/401H

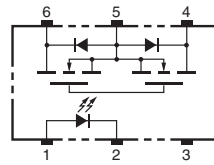

G3VM-353H

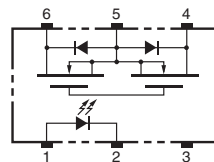

### ■ Dimensions (Unit: mm)

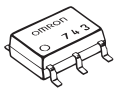

#### Surface-mounting Terminals

Weight: 0.13 g

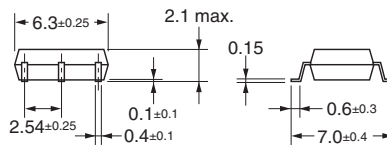
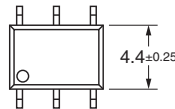

#### Actual Mounting Pad Dimensions

(Recommended Value, Top View)

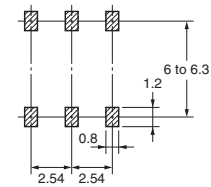

**Note:** The actual product is marked differently from the image shown here.

### ■ Approved Standards

UL recognized

Model	Approved Standards	Contact form	File No.
G3VM-61H1 G3VM-201H1 G3VM-351H	UL (recognized)	1a (SPST-NO)	E80555
G3VM-353H		1b (SPST-NC)	
G3VM-401H		1a (SPST-NO)	

Models Certified by BSI for EN/IEC Standards

Model	Approved Standards	Contact form	File No.
G3VM-401H	EN62368-1 (BSI certified)	1a (SPST-NO)	VC669262

### ■ Safety Precautions

Refer to the *Common Precautions for All MOS FET Relays* for precautions that apply to all MOS FET Relays.

Please check each region's Terms & Conditions by region website.

## OMRON Corporation

Electronic and Mechanical Components Company

### Regional Contact

**Americas**

<https://www.components.omron.com/>

**Asia-Pacific**

<https://ecb.omron.com.sg/>

**Korea**

<https://www.omron-ecb.co.kr/>

**Europe**

<http://components.omron.eu/>

**China**

<https://www.ecb.omron.com.cn/>

**Japan**

<https://www.omron.co.jp/ecb/>