

D2HW

Sealed Ultra Subminiature Basic Switch

Smallest sealed snap-action switch in the industry with a very long stroke for reliable ON/OFF action

- The case dimensions are 78% of conventional models, contributing to down-sizing of mechanical modules.
- Extra-long stroke even without levers. (OT reference value: 1.4 mm).
- Made of environmentally-friendly materials. All models are lead-free, including molded lead wire models.

RoHS Compliant

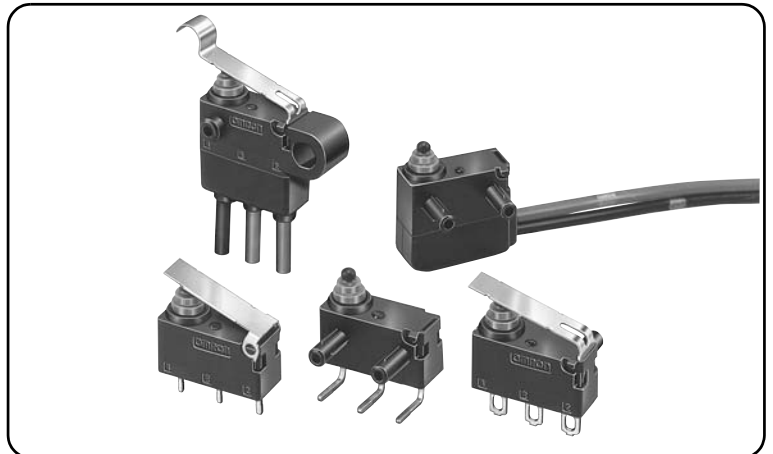

D
2
H
W

Model Number Legend

D2HW - 1 2 3 4 5 6 7

1. Mounting Structure

- A : Without posts (base-mounting)
- BR : Post on right
- BL : Post on left
- C : M3-screw mounting models

2. Ratings

- 2 : 5 VDC 1mA to 12 VDC 2A

3. Actuator

- 0 : Pin plunger
- 1 : Hinge lever
- 2 : Long hinge lever
- 3 : Simulated roller lever
- 4 : Hinge roller lever
- 6 : Leaf lever
- 7 : Simulated roller leaf lever
- 8 : Long leaf lever

4. Contact form

- 1 : SPDT
- 2 : SPST-NC (Molded lead wire models only)
- 3 : SPST-NO (Molded lead wire models only)

5. Terminals

- D, DS : PCB terminals (Straight)
- DR, DRS : PCB Terminals (Right-angled)
- DL, DLS : PCB Terminals (Left-angled)
- H, HS : Solder terminals
- M, MS : Molded lead wires downwards
- MR, MRS : Molded lead wires on right-side
- ML, MLS : Molded lead wires on left-side





Note. UL/CSA approved versions are available.
In this case, a "S" will be added to the end of the model number.
The Lead wire is a UL approved wire (AWG24, UL1007).

6. Special Specification

7. Special Industry Specification

List of Models











●PCB-mounted Models

List of Models				With posts on right 	With posts on left 	Without posts 
Actuator	Terminals	Contact form				
Pin plunger 	For PCB	Straight	SPDT	-	-	D2HW-A201D
		Angled		D2HW-BR201DR	D2HW-BL201DL	-
Straight		-		-	D2HW-A211D	
Angled		D2HW-BR211DR		D2HW-BL211DL	-	
Straight		-		-	D2HW-A221D	
Angled		D2HW-BR221DR		D2HW-BL221DL	-	
Hinge lever 	For PCB	Straight	SPDT	-	-	D2HW-A231D
		Angled		D2HW-BR231DR	D2HW-BL231DL	-

Note1. Angled terminals and posts are the same direction.

Note2. "S" is added to the end of the model number for the UL/CSA-approved version Consult your OMRON sales representative for details.

●Models with Solder Terminals or Molded Lead Wires

List of Models				With posts on right 	With posts on left 	M3-screw mounting 
Actuator	Terminals	Contact form				
Pin plunger 	Solder	Downwards	SPDT	D2HW-BR201H	D2HW-BL201H	D2HW-C201H
			SPDT	D2HW-BR201M	D2HW-BL201M	D2HW-C201M
	Molded lead wires	Downwards	SPST-NC	D2HW-BR202M	D2HW-BL202M	D2HW-C202M
			SPST-NO	D2HW-BR203M	D2HW-BL203M	D2HW-C203M
		Right-side	SPST-NC	D2HW-BR202MR	D2HW-BL202MR	D2HW-C202MR
			SPST-NO	D2HW-BR203MR	D2HW-BL203MR	D2HW-C203MR
		Left-side	SPST-NC	D2HW-BR202ML	D2HW-BL202ML	-
			SPST-NO	D2HW-BR203ML	D2HW-BL203ML	-
Hinge lever 	Solder	Downwards	SPDT	D2HW-BR211H	D2HW-BL211H	D2HW-C211H
			SPDT	D2HW-BR211M	D2HW-BL211M	D2HW-C211M
	Molded lead wires	Downwards	SPST-NC	D2HW-BR212M	D2HW-BL212M	D2HW-C212M
			SPST-NO	D2HW-BR213M	D2HW-BL213M	D2HW-C213M
		Right-side	SPST-NC	D2HW-BR212MR	D2HW-BL212MR	D2HW-C212MR
			SPST-NO	D2HW-BR213MR	D2HW-BL213MR	D2HW-C213MR
		Left-side	SPST-NC	D2HW-BR212ML	D2HW-BL212ML	-
			SPST-NO	D2HW-BR213ML	D2HW-BL213ML	-
Long hingelever 	Solder	Downwards	SPDT	D2HW-BR221H	D2HW-BL221H	D2HW-C221H
			SPDT	D2HW-BR221M	D2HW-BL221M	D2HW-C221M
	Molded lead wires	Downwards	SPST-NC	D2HW-BR222M	D2HW-BL222M	D2HW-C222M
			SPST-NO	D2HW-BR223M	D2HW-BL223M	D2HW-C223M
		Right-side	SPST-NC	D2HW-BR222MR	D2HW-BL222MR	D2HW-C222MR
			SPST-NO	D2HW-BR223MR	D2HW-BL223MR	D2HW-C223MR
		Left-side	SPST-NC	D2HW-BR222ML	D2HW-BL222ML	-
			SPST-NO	D2HW-BR223ML	D2HW-BL223ML	-
Simulated roller hinge lever 	Solder	Downwards	SPDT	D2HW-BR231H	D2HW-BL231H	D2HW-C231H
			SPDT	D2HW-BR231M	D2HW-BL231M	D2HW-C231M
	Molded lead wires	Downwards	SPST-NC	D2HW-BR232M	D2HW-BL232M	D2HW-C232M
			SPST-NO	D2HW-BR233M	D2HW-BL233M	D2HW-C233M
		Right-side	SPST-NC	D2HW-BR232MR	D2HW-BL232MR	D2HW-C232MR
			SPST-NO	D2HW-BR233MR	D2HW-BL233MR	D2HW-C233MR
		Left-side	SPST-NC	D2HW-BR232ML	D2HW-BL232ML	-
			SPST-NO	D2HW-BR233ML	D2HW-BL233ML	-
Hinge roller lever 	Solder	Downwards	SPDT	D2HW-BR241H	D2HW-BL241H	D2HW-C241H
			SPDT	D2HW-BR241M	D2HW-BL241M	D2HW-C241M
	Molded lead wires	Downwards	SPST-NC	D2HW-BR242M	D2HW-BL242M	D2HW-C242M
			SPST-NO	D2HW-BR243M	D2HW-BL243M	D2HW-C243M
		Right-side	SPST-NC	D2HW-BR242MR	D2HW-BL242MR	D2HW-C242MR
			SPST-NO	D2HW-BR243MR	D2HW-BL243MR	D2HW-C243MR
		Left-side	SPST-NC	D2HW-BR242ML	D2HW-BL242ML	-
			SPST-NO	D2HW-BR243ML	D2HW-BL243ML	-
Leaf lever 	Solder	Downwards	SPDT	D2HW-BR261H	D2HW-BL261H	D2HW-C261H
			SPDT	D2HW-BR261M	D2HW-BL261M	D2HW-C261M
	Molded lead wires	Downwards	SPST-NC	D2HW-BR262M	D2HW-BL262M	D2HW-C262M
			SPST-NO	D2HW-BR263M	D2HW-BL263M	D2HW-C263M
		Right-side	SPST-NC	D2HW-BR262MR	D2HW-BL262MR	D2HW-C262MR
			SPST-NO	D2HW-BR263MR	D2HW-BL263MR	D2HW-C263MR
		Left-side	SPST-NC	D2HW-BR262ML	D2HW-BL262ML	-
			SPST-NO	D2HW-BR263ML	D2HW-BL263ML	-
Simulated roller leaf lever 	Solder	Downwards	SPDT	D2HW-BR271H	D2HW-BL271H	D2HW-C271H
			SPDT	D2HW-BR271M	D2HW-BL271M	D2HW-C271M
	Molded lead wires	Downwards	SPST-NC	D2HW-BR272M	D2HW-BL272M	D2HW-C272M
			SPST-NO	D2HW-BR273M	D2HW-BL273M	D2HW-C273M
		Right-side	SPST-NC	D2HW-BR272MR	D2HW-BL272MR	D2HW-C272MR
			SPST-NO	D2HW-BR273MR	D2HW-BL273MR	D2HW-C273MR
		Left-side	SPST-NC	D2HW-BR272ML	D2HW-BL272ML	-
			SPST-NO	D2HW-BR273ML	D2HW-BL273ML	-
Long leaf lever 	Molded lead wires	Downwards	SPDT	D2HW-BR281M	D2HW-BL281M	D2HW-C281M
			SPST-NC	D2HW-BR282M	D2HW-BL282M	D2HW-C282M
		Right-side	SPST-NO	D2HW-BR283M	D2HW-BL283M	D2HW-C283M
			SPST-NC	-	-	D2HW-C282MR
			SPST-NO	-	-	D2HW-C283MR

Note1. The length of standard lead wires (AVSS 0.5) for molded lead wire models shown above is 30 cm.

Note2. "S" is added to the end of the model number for the UL/CSA-approved version The lead wire models are UL approved wires (AWG24, UL1007). Consult your OMRON sales representative for details.

Contact form

●SPDT

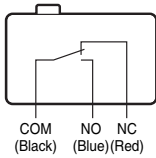

● SPST-NC, (Molded Lead Wire Models Only)

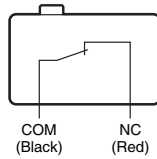

● SPST-NO, (Molded Lead Wire Models Only)

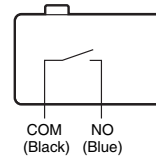

Molded lead wire colors are indicated in parentheses.

Contact Specifications

Contact	Specification	Crossbar
	Material	Gold alloy
	Gap (standard value)	0.5 mm
Minimum applicable load (see note)		5 VDC 1mA

Ratings

Rated voltage	Resistive load
125 VAC	0.1A
12 VDC	2A
24 VDC	1A
42 VDC	0.5A

Note. The above rating values apply under the following test conditions.

- (1) Ambient temperature: 20±2°C
- (2) Ambient humidity: 65±5 %
- (3) Operating frequency: 30 operations/min

Approved Safety Standard

Consult your OMRON sales representative for specific models with standard approvals.

UL (UL1054/CSA C22.2 No.55)

Model	D2HW
Rated voltage	Resistive load
125 VAC	0.1A
12 VDC	2A
24 VDC	1A
42 VDC	0.5A

Characteristics

Permissible operating speed	1 mm to 500 mm/s (for pin plunger models)	
Permissible operating frequency	30 operations/min	
Insulation resistance	100 MΩ min. (at 500 VDC with insulation tester)	
Contact resistance (initial value)	Terminals	100 mΩ max.
	Molded lead wire models	150 mΩ max.
Dielectric strength	Between terminals of the same polarity	600 VAC 50/60 Hz 1min
	Between current-carrying metal parts and ground	1,500 VAC 50/60 Hz 1 min
	Between terminals and non-current-carrying metal parts	1,500 VAC 50/60 Hz 1 min
Vibration resistance * 1	Malfunction	10 to 55 Hz, 1.5 mm double amplitude
Shock resistance	Durability	1,000 m/s ² {approx. 100G} max.
	Malfunction * 1	300 m/s ² {approx. 30G} max.
Durability * 2	Mechanical	1,000,000 operations min. (30 operations/min)
	Electrical	100,000 operations min. (20 operations/min)
Degree of protection	Terminals	IEC IP67 (excluding the terminals on terminal models)
	molded lead wire models	IEC IP67
Ambient operating temperature	-40 to +85°C (at ambient humidity of 60% max.) (with no icing or condensation)	
Ambient operating humidity	95% max. (for +5 to +35°C)	
Weight	Approx. 0.7 g (for pin plunger models with terminals)	

Note. The data given above are initial values.

*1. For the pin plunger models, the above values apply for use at the free position, operating position, and total travel position. For the lever models, they apply at the total travel position. Close or open circuit of the contact is 1ms max.

*2. For testing conditions, consult your OMRON sales representative.

Mounting Structure and Reference Positions for Operating Characteristics (Unit: mm)

●Without posts D2HW-A□

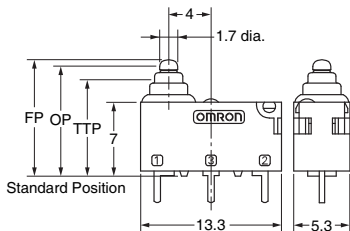

●Models with Posts D2HW-B□

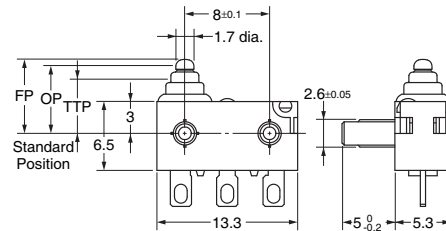

Mounting Hole Dimensions (Reference)

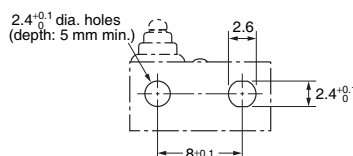

●M3-screw Mounting Models D2HW-C□

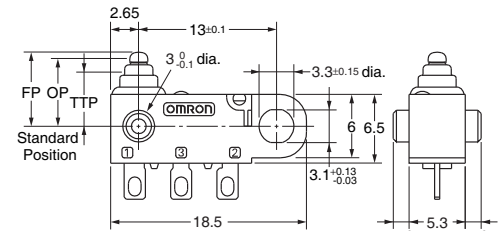

Mounting Hole Dimensions (Reference)

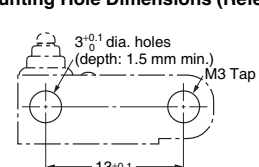

Note. The reference positions used for Free Position (FP), Operating Position (OP), and Total Travel Position (TTP) values are as shown above for each type of mounting.

Terminals/Apearances (Unit: mm)

●PCB terminals (Straight)

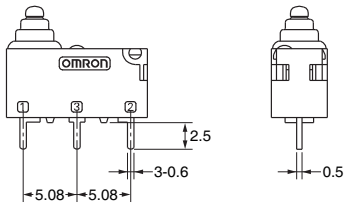

●PCB Terminals (Left-angled)

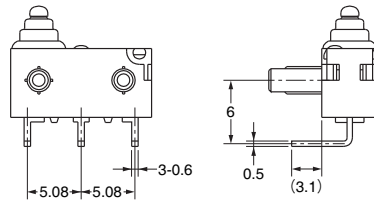

●PCB terminals (Right-angled)

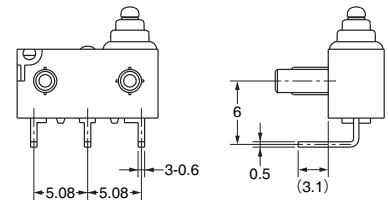

<PCB Mounting Dimensions (Reference)>

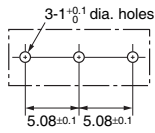

<PCB Cutout Dimensions (Reference)>

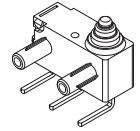
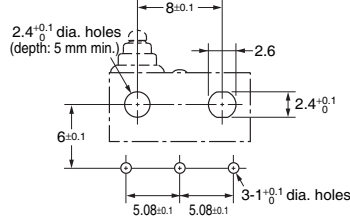

●Solder terminals

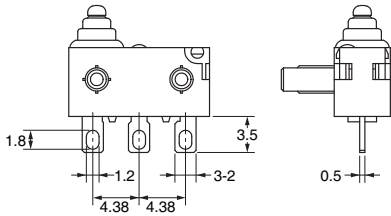

●Molded Lead Wires on Left-side

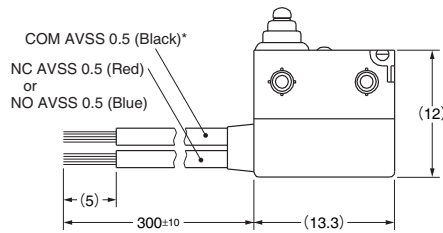

* UL approved wires (AWG24, UL1007) are used for UL/CSA standard approved items.

●Molded Lead Wires on Right-side

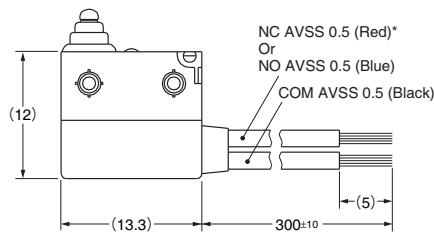

* UL approved wires (AWG24, UL1007) are used for UL/CSA standard approved items.

●Molded Lead Wires Downwards

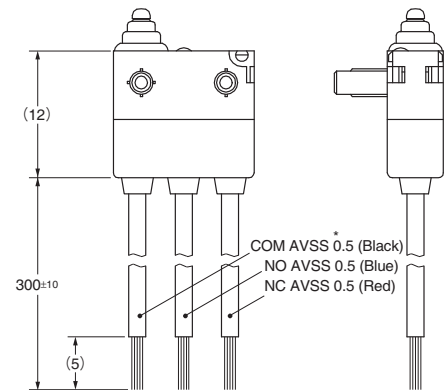

* UL approved wires (AWG24, UL1007) are used for UL/CSA standard approved items.

Dimensions (Unit: mm)/Operating Characteristics

The following illustrations and drawings are representative models. When ordering, replace □ with the code for the mounting structure, contact form and terminal that you need.

See the "■List of Models" for available combinations of appearances.
Refer to page 3 to 4 for the mounting structures and terminal forms.

●Pin plunger

D2HW-□20□□

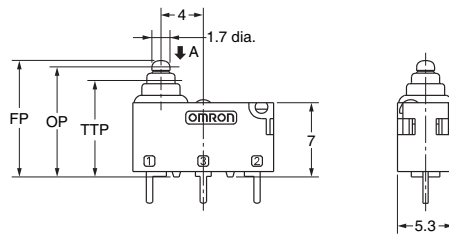

Operating characteristics	Type	Without posts	Models with Posts	M3-screw Mounting Models
Operating Force	OF Max.	0.75N {76 gf}		
Releasing Force	RF Min.	0.10N {10 gf}		
Overtravel	OT	1.4 mm (reference value)		
Movement Differential	MD Max.	0.25 mm		
Free Position	FP Max.	11.2 mm	7.2 mm	
Operating Position	OP	10.4±0.2 mm	6.4±0.2 mm	
Total Travel Position	TTP Max.	9.1 mm	5.1 mm	

●Hinge Lever

D2HW-□21□□

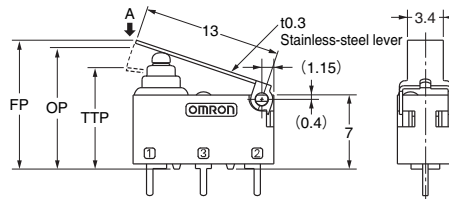

Operating characteristics	Type	Without posts	Models with Posts	M3-screw Mounting Models
Operating Force	OF Max.	0.75N {76 gf}		
Releasing Force	RF Min.	0.07N {7 gf}		
Overtravel	OT	1.6 mm (reference value)		
Movement Differential	MD Max.	0.5 mm		
Free Position	FP Max.	12.8 mm	8.8 mm	
Operating Position	OP	11.5±0.5 mm	7.5±0.5 mm	
Total Travel Position	TTP Max.	10 mm	6 mm	

●Long Hinge Lever

D2HW-□22□□

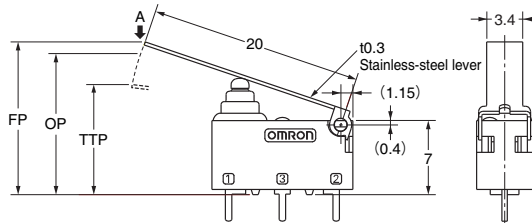

Operating characteristics	Type	Without posts	Models with Posts	M3-screw Mounting Models
Operating Force	OF Max.	0.5N {50 gf}		
Releasing Force	RF Min.	0.03N {3 gf}		
Overtravel	OT	2.5 mm (reference value)		
Movement Differential	MD Max.	0.8 mm		
Free Position	FP Max.	15.5 mm	11.5 mm	
Operating Position	OP	13.3±0.8 mm	9.3±0.8 mm	
Total Travel Position	TTP Max.	11 mm	7 mm	

●Simulated Roller Lever

D2HW-□23□□

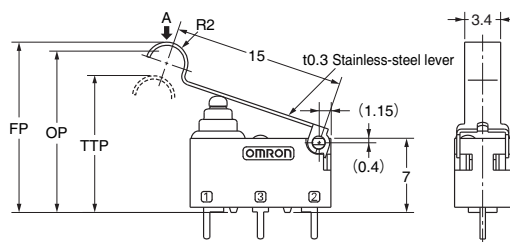

Operating characteristics	Type	Without posts	Models with Posts	M3-screw Mounting Models
Operating Force	OF Max.	0.65N {66 gf}		
Releasing Force	RF Min.	0.05N {5 gf}		
Overtravel	OT	1.9 mm (reference value)		
Movement Differential	MD Max.	0.5 mm		
Free Position	FP Max.	16.5 mm	12.5 mm	
Operating Position	OP	15.2±0.5 mm	11.2±0.5 mm	
Total Travel Position	TTP Max.	13.5 mm	9.5 mm	

●Hinge Roller Lever

D2HW-□24□□

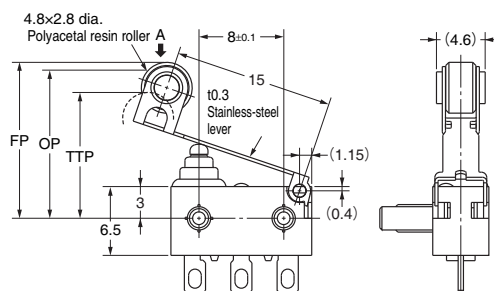

Operating characteristics	Type	Models with Posts	M3-screw Mounting Models
Operating Force	OF Max.	0.65N {66 gf}	
Releasing Force	RF Min.	0.03N {3 gf}	
Overtravel	OT	1.9 mm (reference value)	
Movement Differential	MD Max.	0.6 mm	
Free Position	FP Max.	15.3 mm	
Operating Position	OP	14±0.6 mm	
Total Travel Position	TTP Max.	12.3 mm	

Note1. Unless otherwise specified, a tolerance of ±0.2mm applies to all dimensions.
Note2. The operating characteristics are for operation in the A direction (↓).

●Leaf Lever

D2HW-□26□□

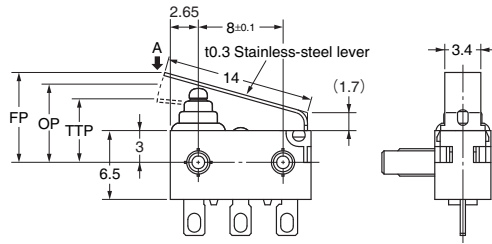

Operating characteristics	Type	Models with Posts	M3-screw Mounting Models
Operating Force	OF Max.	1.8N {183 gf}	
Releasing Force	RF Min.	0.20N {20 gf}	
Overtravel	OT	1.8 mm (reference value)	
Movement Differential	MD Max.	0.5 mm	
Free Position	FP Max.	9.3 mm	
Operating Position	OP	7.4±0.5 mm	
Total Travel Position	TTP Max.	5.8 mm	

D
2
H
W

●Simulated Roller Lever

D2HW-□27□□

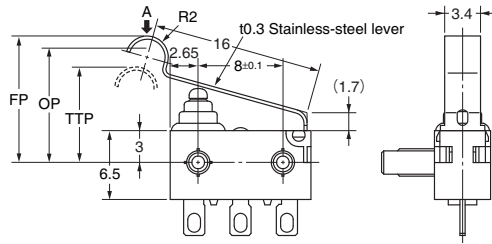

Operating characteristics	Type	Models with Posts	M3-screw Mounting Models
Operating Force	OF Max.	1.8N {183 gf}	
Releasing Force	RF Min.	0.20N {20 gf}	
Overtravel	OT	2.0 mm (reference value)	
Movement Differential	MD Max.	0.5 mm	
Free Position	FP Max.	13.0 mm	
Operating Position	OP	10.8±0.5 mm	
Total Travel Position	TTP Max.	8.9 mm	

●Long Leaf Lever

D2HW-□28□□

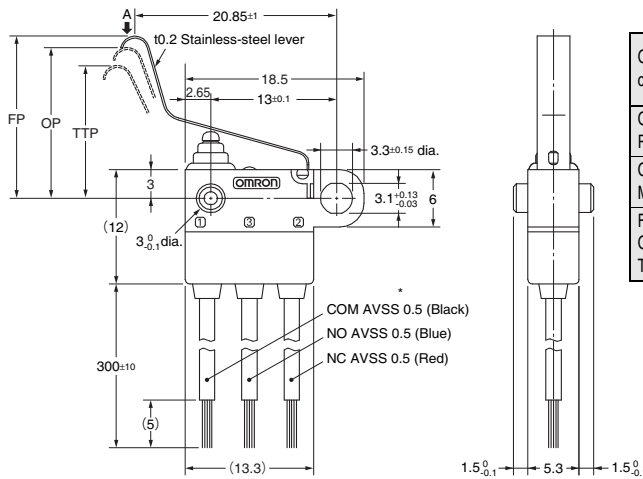

Operating characteristics	Type	Models with Posts	M3-screw Mounting Models
Operating Force	OF Max.	0.9N {92 gf}	
Releasing Force	RF Min.	0.05N {5 gf}	
Overtravel	OT	2.8 mm (reference value)	
Movement Differential	MD Max.	0.7 mm	
Free Position	FP Max.	19 mm	
Operating Position	OP	15.4±1.5 mm	
Total Travel Position	TTP Max.	12.8 mm	

* UL approved wires (AWG24, UL1007) are used for UL/CSA standard approved items.

Note1. Unless otherwise specified, a tolerance of ±0.2mm applies to all dimensions.

Note2. The operating characteristics are for operation in the A direction (↓).

Precautions

★Please refer to "General Information" for correct use.

Cautions

●Degree of Protection

- Do not use this product underwater.
Although molded lead wire models satisfy the test conditions for the standard given below, this test is to check the ingress of water into the switch enclosure after submerging the Switch in water for a given time. Satisfying this test condition does not mean that the Switch can be used underwater.

JIS C0920:

Degrees of protection provided by enclosures of electrical apparatus (IP Code)

IEC 60529:

Degrees of protection provided by enclosures (IP Code)

Degree of protection: IP67

(check water intrusion after immersion for 30 min. submerged 1m underwater)

- Do not operate the Switch when it is exposed to water spray, or when water drops adhere to the Switch surface, or during sudden temperature changes, otherwise water may intrude into the interior of the Switch due to a suction effect.
- Prevent the Switch from coming into contact with oil and chemicals.
Otherwise, damage to or deterioration of Switch materials may result.
- Do not use the Switch in areas where it is exposed to silicon adhesives, oil, or grease. Otherwise faulty contact may result due to the generation of silicon oxide.

●Soldering

When soldering the lead wire to the terminal, first insert the lead wire conductor through the terminal hole and then conduct soldering.

Make sure that the temperature of the soldering iron tip does not exceed 300°C, and complete the soldering within 3 seconds. Do not apply any external force for 1 minute after soldering.

Soldering at an excessively high temperature or soldering for more than 3 seconds may deteriorate the characteristics of the Switch.

In case of automatic soldering, please do not apply the heat beyond 260°C within 5 seconds. Pay careful attention so that flux or solder liquid does not flow over the edge of the PCB panel.

●Side-actuated (Cam/Dog) Operation

- When using a cam or dog to operate the Switch, factors such as the operating speed, operating frequency, push-button indentation, and material and shape of the cam or dog will affect the durability of the Switch. Confirm performance specifications under actual operating conditions before using the Switch in applications.

Correct Use

●Mounting

- Turn OFF the power supply before mounting or removing the Switch, wiring, or performing maintenance or inspection. Failure to do so may result in electric shock or burning.
- For M3-screw mounting models, use M3 mounting screws with plane washers or spring washers to securely mount the Switch.
Tighten the screws to a torque of 0.27 to 0.29 N·m {27.5 to 29.5 gf}. Exceeding the specified torque may result in deterioration of the sealing or damage.
- For models with posts, secure the posts by thermal caulking or by pressing into an attached device. When pressed into an attached device, provide guides on the opposite ends of the posts to ensure that they do not fall out or rattle.
Thermal caulking conditions varies according to the equipment, jig and base used for switch mounting. Consult your OMRON sales representative for details.

●Operating Body

- Use an operating body with low frictional resistance and of a shape that will not interfere with the sealing rubber, otherwise the plunger may be damaged or the sealing may deteriorate.

●Handling

- Do not handle the Switch in a way that may cause damage to the sealing rubber.
- When handling the Switch, ensure that pressure is not applied to the posts in the directions shown in the following diagram. Also, ensure that uneven pressure or pressure in a direction other than the operating direction is not applied to the Actuator as shown in the following diagram. Otherwise, the post, Actuator, or Switch may be damaged, or the service life may be reduced.

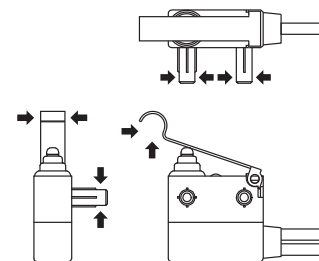

●Wiring Molded Lead Wire Models

- When wiring molded lead wire models, ensure that there is no weight applied on the wire or that there are no sharp bends near the parts where the wire is drawn out. Otherwise, damage to the Switch or deterioration in the sealing may result.

●Using Micro Loads

- Even when using micro load models within the operating range shown below, if inrush/surge current occurs, it may increase the contact wear and so decrease durability. Therefore, insert a contact protection circuit where necessary.

• Application examples provided in this document are for reference only. In actual applications, confirm equipment functions and safety before using the product.
• Consult your OMRON representative before using the product under conditions which are not described in the manual or applying the product to nuclear control systems, railroad systems, aviation systems, vehicles, combustion systems, medical equipment, amusement machines, safety equipment, and other systems or equipment that may have a serious influence on lives and property if used improperly. Make sure that the ratings and performance characteristics of the product provide a margin of safety for the system or equipment, and be sure to provide the system or equipment with double safety mechanisms.

Note: Do not use this document to operate the Unit.