

## Product Discontinuation Notice

Issue Date  
February, 2023

### Product Discontinuation

Slim I/O Relay  
Slim I/O Slid State Relay



**G2RV-SR series**  
**G3RV-SR series**  
**PYDN-6.2 series**  
**P2RVC-8 series**

### Recommended Replacement

Slim I/O Relay  
Slim I/O Solid State Relay



**G2RV-ST series**  
**G3RV-ST series**  
**PYDN-6.2ST series**  
**P2RVC-8ST series**

#### [ Final order entry date ]

The end of March, 2024

#### [ Date of The Last Shipping ]

The end of June, 2024

#### [ Caution on recommended replacement ]

- There is no change the mounted Relay or SSR.
- Dedicated accessories (PYDN-6.2 series, P2RVC-8 series) for G2RV-SR/G3RV-SR are not compatible and cannot be used.
- There are no 2,3,4,10 pole types for the PYDN-6.2ST series. When using other than 20 pole, cut 20 pole before using. However, since the metal on the cut surface will be exposed, human safety and insulation countermeasures between adjacent products must be ensured. Such countermeasures include using isolation plate model P2RV-P3.1ST or taking an equivalent insulation countermeasure.

#### [ Difference from discontinued product ]

Recommended replacement Model	Body Color	Dimensions	Wire connection	Mounting Dimensions	Characteristics	Operation ratings	Operation methods
G2RV-ST500	**	*	**	*	**	**	*
G2RV-ST500-AP	**	*	**	*	**	**	*
G2RV-ST501	**	*	**	*	**	**	*
G2RV-ST700	**	*	**	*	**	**	*
G2RV-ST700-AP	**	*	**	*	**	**	*
G2RV-ST701	**	*	**	*	**	**	*
G3RV-ST500	**	*	**	*	*	**	*
G3RV-ST500-AP	**	*	**	*	*	**	*
G3RV-ST501	**	*	**	*	*	**	*
G3RV-ST700	**	*	**	*	*	**	*
G3RV-ST700-AP	**	*	**	*	*	**	*
G3RV-ST701	**	*	**	*	*	**	*

\*\* : Compatible

\* : The change is a little/Almost compatible

-- : Not compatible

- : No corresponding specification

**[ Difference from discontinued product ] continue**

Recommended replacement Model	Body Color	Dimensions	Wire connection	Mounting Dimensions	Characteristics	Operation ratings	Operation methods
PYDN-6.2ST-200R	**	--	**	*	**	**	**
PYDN-6.2ST-200S	**	--	**	*	**	**	**
PYDN-6.2ST-200Y	**	--	**	*	**	**	**
P2RVC-8ST-I-5	**	--	**	*	*	**	**
P2RVC-8ST-I-5-1	**	--	**	*	*	**	**
P2RVC-8ST-I-7-1	**	--	**	*	*	**	**
P2RVC-8ST-O-5	**	--	**	*	*	**	**
P2RVC-8ST-O-5-1	**	--	**	*	*	**	**
P2RVC-8ST-O-7-1	**	--	**	*	*	**	**

- \*\* : Compatible
- \* : The change is a little/Almost compatible
- : Not compatible
- : No corresponding specification







**[ Product Discontinuation and recommended replacement ]**

Product discontinuation	Recommended replacement
G2RV-SR500 AC/DC24	G2RV-ST500 AC/DC24
G2RV-SR500 AC/DC48	G2RV-ST500 AC/DC48
G2RV-SR500 AC100	G2RV-ST500 AC100
G2RV-SR500 AC110	G2RV-ST500 AC110
G2RV-SR500 AC200	G2RV-ST500 AC200
G2RV-SR500 AC230	G2RV-ST500 AC230
G2RV-SR500 DC12	G2RV-ST500 DC12
G2RV-SR500 DC24	G2RV-ST500 DC24
G2RV-SR500-AP AC/DC24	G2RV-ST500-AP AC/DC24
G2RV-SR500-AP AC/DC48	G2RV-ST500-AP AC/DC48
G2RV-SR500-AP AC100	G2RV-ST500-AP AC100
G2RV-SR500-AP AC110	G2RV-ST500-AP AC110
G2RV-SR500-AP AC200	G2RV-ST500-AP AC200
G2RV-SR500-AP AC230	G2RV-ST500-AP AC230
G2RV-SR500-AP DC12	G2RV-ST500-AP DC12
G2RV-SR500-AP DC24	G2RV-ST500-AP DC24
G2RV-SR501 AC/DC24	G2RV-ST501 AC/DC24
G2RV-SR501 DC24	G2RV-ST501 DC24
G2RV-SR700 AC/DC24	G2RV-ST700 AC/DC24
G2RV-SR700 AC/DC48	G2RV-ST700 AC/DC48
G2RV-SR700 AC100	G2RV-ST700 AC100
G2RV-SR700 AC110	G2RV-ST700 AC110
G2RV-SR700 AC200	G2RV-ST700 AC200
G2RV-SR700 AC230	G2RV-ST700 AC230
G2RV-SR700 DC12	G2RV-ST700 DC12
G2RV-SR700 DC24	G2RV-ST700 DC24
G2RV-SR700-AP AC/DC24	G2RV-ST700-AP AC/DC24
G2RV-SR700-AP AC/DC48	G2RV-ST700-AP AC/DC48
G2RV-SR700-AP AC100	G2RV-ST700-AP AC100

<b>Product discontinuation</b>	<b>Recommended replacement</b>
G2RV-SR700-AP AC110	G2RV-ST700-AP AC110
G2RV-SR700-AP AC200	G2RV-ST700-AP AC200
G2RV-SR700-AP AC230	G2RV-ST700-AP AC230
G2RV-SR700-AP DC12	G2RV-ST700-AP DC12
G2RV-SR700-AP DC24	G2RV-ST700-AP DC24
G2RV-SR701 AC/DC24	G2RV-ST701 AC/DC24
G2RV-SR701 DC24	G2RV-ST701 DC24
G3RV-SR500-A AC/DC24	G3RV-ST500-A AC/DC24
G3RV-SR500-A AC/DC48	G3RV-ST500-A AC/DC48
G3RV-SR500-A AC100	G3RV-ST500-A AC100
G3RV-SR500-A AC110	G3RV-ST500-A AC110
G3RV-SR500-A AC200	G3RV-ST500-A AC200
G3RV-SR500-A AC230	G3RV-ST500-A AC230
G3RV-SR500-A DC12	G3RV-ST500-A DC12
G3RV-SR500-A DC24	G3RV-ST500-A DC24
G3RV-SR500-AL AC/DC24	G3RV-ST500-AL AC/DC24
G3RV-SR500-AL AC/DC48	G3RV-ST500-AL AC/DC48
G3RV-SR500-AL AC100	G3RV-ST500-AL AC100
G3RV-SR500-AL AC110	G3RV-ST500-AL AC110
G3RV-SR500-AL AC200	G3RV-ST500-AL AC200
G3RV-SR500-AL AC230	G3RV-ST500-AL AC230
G3RV-SR500-AL DC12	G3RV-ST500-AL DC12
G3RV-SR500-AL DC24	G3RV-ST500-AL DC24
G3RV-SR500-D AC/DC24	G3RV-ST500-D AC/DC24
G3RV-SR500-D AC/DC48	G3RV-ST500-D AC/DC48
G3RV-SR500-D AC100	G3RV-ST500-D AC100
G3RV-SR500-D AC110	G3RV-ST500-D AC110
G3RV-SR500-D AC200	G3RV-ST500-D AC200
G3RV-SR500-D AC230	G3RV-ST500-D AC230
G3RV-SR500-D DC12	G3RV-ST500-D DC12
G3RV-SR500-D DC24	G3RV-ST500-D DC24
G3RV-SR700-A AC/DC24	G3RV-ST700-A AC/DC24
G3RV-SR700-A AC/DC48	G3RV-ST700-A AC/DC48
G3RV-SR700-A AC100	G3RV-ST700-A AC100
G3RV-SR700-A AC110	G3RV-ST700-A AC110
G3RV-SR700-A AC200	G3RV-ST700-A AC200
G3RV-SR700-A AC230	G3RV-ST700-A AC230
G3RV-SR700-A DC12	G3RV-ST700-A DC12
G3RV-SR700-A DC24	G3RV-ST700-A DC24
G3RV-SR700-AL AC/DC24	G3RV-ST700-AL AC/DC24
G3RV-SR700-AL AC/DC48	G3RV-ST700-AL AC/DC48
G3RV-SR700-AL AC100	G3RV-ST700-AL AC100
G3RV-SR700-AL AC110	G3RV-ST700-AL AC110
G3RV-SR700-AL AC200	G3RV-ST700-AL AC200
G3RV-SR700-AL AC230	G3RV-ST700-AL AC230
G3RV-SR700-AL DC12	G3RV-ST700-AL DC12
G3RV-SR700-AL DC24	G3RV-ST700-AL DC24
G3RV-SR700-D AC/DC24	G3RV-ST700-D AC/DC24
G3RV-SR700-D AC/DC48	G3RV-ST700-D AC/DC48
G3RV-SR700-D AC100	G3RV-ST700-D AC100

<b>Product discontinuation</b>	<b>Recommended replacement</b>
G3RV-SR700-D AC110	G3RV-ST700-D AC110
G3RV-SR700-D AC200	G3RV-ST700-D AC200
G3RV-SR700-D AC230	G3RV-ST700-D AC230
G3RV-SR700-D DC12	G3RV-ST700-D DC12
G3RV-SR700-D DC24	G3RV-ST700-D DC24
P2RVC-8-I-5	P2RVC-8ST-I-5
P2RVC-8-I-5-1	P2RVC-8ST-I-5-1
P2RVC-8-I-7-1	P2RVC-8ST-I-7-1
P2RVC-8-O-5	P2RVC-8ST-O-5
P2RVC-8-O-5-1	P2RVC-8ST-O-5-1
P2RVC-8-O-7-1	P2RVC-8ST-O-7-1
PYDN-6.2-020R	Please cut 20 poles before use.
PYDN-6.2-020S	Please cut 20 poles before use.
PYDN-6.2-020Y	Please cut 20 poles before use.
PYDN-6.2-030R	Please cut 20 poles before use.
PYDN-6.2-030S	Please cut 20 poles before use.
PYDN-6.2-030Y	Please cut 20 poles before use.
PYDN-6.2-040R	Please cut 20 poles before use.
PYDN-6.2-040S	Please cut 20 poles before use.
PYDN-6.2-040Y	Please cut 20 poles before use.
PYDN-6.2-100R	Please cut 20 poles before use.
PYDN-6.2-100S	Please cut 20 poles before use.
PYDN-6.2-100Y	Please cut 20 poles before use.
PYDN-6.2-200R	PYDN-6.2ST-200R
PYDN-6.2-200S	PYDN-6.2ST-200S
PYDN-6.2-200Y	PYDN-6.2ST-200Y

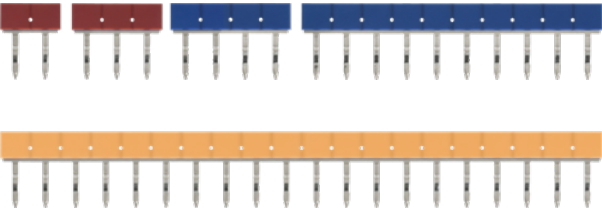
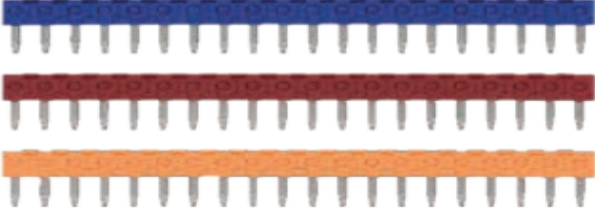
[ Body color ]

<p>Product discontinuation                      Model G2RV-SR series                      Model G3RV-SR series                      Model PYDN-6.2 series                      Model P2RVC-8 series</p>	<p>Recommendable replacement                      Model G2RV-ST series                      Model G3RV-ST series                      Model PYDN-6.2ST series                      Model P2RVC-8ST series</p>
<p><b>G2RV-SR series</b>                      Color: Dark gray</p> 	<p><b>G2RV-ST series</b>                      Color: Dark gray</p> <div data-bbox="1294 331 1481 376" style="border: 1px solid black; padding: 2px; display: inline-block;">Compatible</div> 
<p><b>G3RV-SR series</b>                      Color: Dark gray</p> 	<p><b>G3RV-ST series</b>                      Color: Dark gray</p> <div data-bbox="1294 795 1481 840" style="border: 1px solid black; padding: 2px; display: inline-block;">Compatible</div> 
<p><b>PYDN-6.2 series</b>                      Color: Red, Blue, Yellow</p> 	<p><b>PYDN-6.2ST series</b>                      Color: Red, Blue, Yellow</p> <div data-bbox="1294 1227 1481 1272" style="border: 1px solid black; padding: 2px; display: inline-block;">Compatible</div> 
<p><b>P2RVC-8 series</b>                      Color: Black</p> 	<p><b>P2RVC-8ST series</b>                      Color: Black</p> <div data-bbox="1294 1563 1481 1608" style="border: 1px solid black; padding: 2px; display: inline-block;">Compatible</div> 

[ Dimensions ]

**Product discontinuation  
Model G2RV-SR series**

**G2RV-SR500, G2RV-SR500-AP**

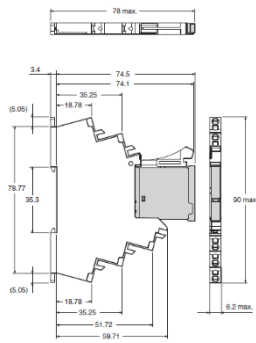

**G2RV-SR501**

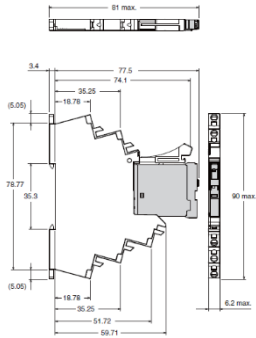

**G2RV-SR700, G2RV-SR700-AP**

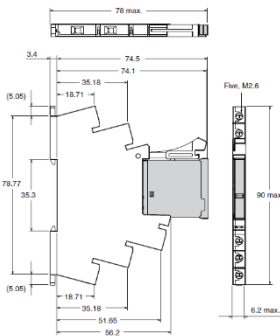

**G2RV-SR701**

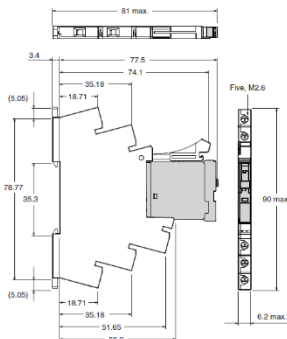

**Recommendable replacement  
Model G2RV-ST series**

**G2RV-ST500, G2RV-ST500-AP**

Almost compatible

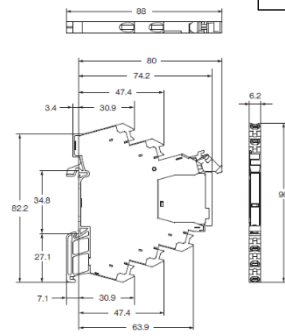

**G2RV-ST501**

Almost compatible

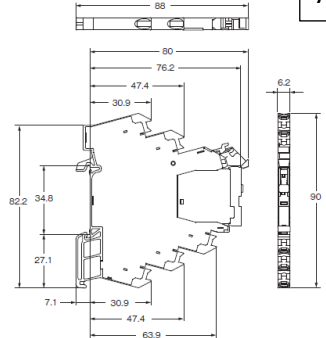

**G2RV-ST700, G2RV-ST700-AP**

Almost compatible

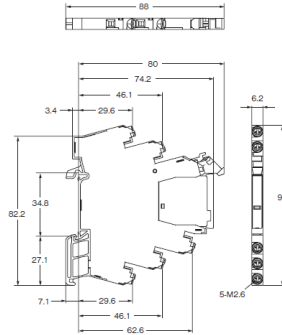

**G2RV-ST701**

Almost compatible

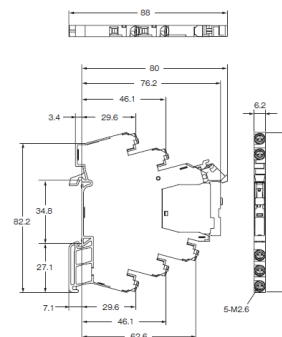

**Product discontinuation**  
**Model G3RV-SR series**  
**Model PYDN-6.2 series**

**G3RV-SR500-A, G3RV-SR500-AL, G3RV-SR500-D**

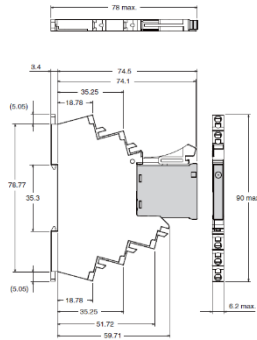

**G3RV-SR700-A, G3RV-SR700-AL, G3RV-SR700-D**

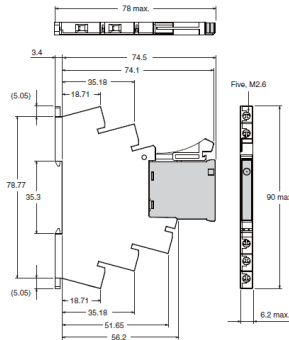

**PYDN-6.2-020□, PYDN-6.2-030□, PYDN-6.2-040□**  
**PYDN-6.2-100□, PYDN-6.2-200□**

□ color selection: R = Red, S = Blue, Y = Yellow

\*These cannot use the G2RV-ST/G3RV-ST

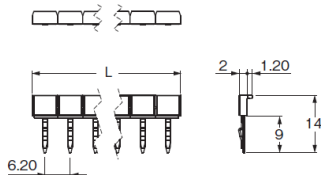

Pitch	No. of poles	Length
6.2 mm	2	12.4 mm
	3	18.6 mm
	4	24.8 mm
	10	62 mm
	20	124 mm

**Recommendable replacement**  
**Model G3RV-ST series**  
**Model PYDN-6.2ST series**

**G3RV-ST500-A, G3RV-ST500-AL, G3RV-ST500-D**

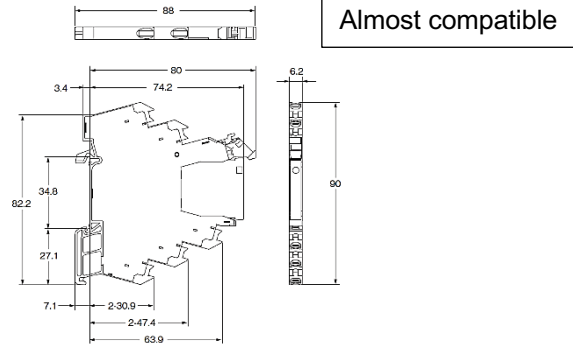

**G3RV-ST700-A, G3RV-ST700-AL, G3RV-ST700-D**

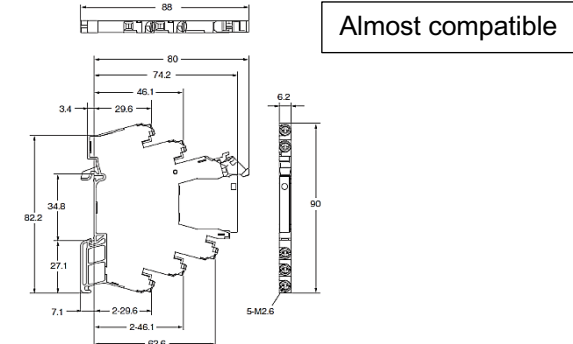

**PYDN-6.2ST-200□**

Not compatible

□ color selection: R = Red, S = Blue, Y = Yellow

\*There are no 2,3,4,10 pole types for the PYDN-6.2ST series.

\*These cannot use the G2RV-SR/G3RV-SR

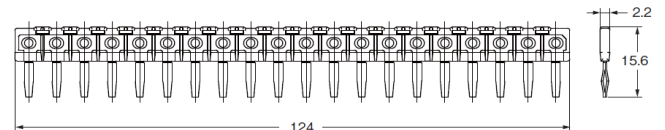

Pitch	No. of poles	Length
6.2 mm	20	124 mm

When using other than 20 pole, cut 20 pole before using. However, since the metal on the cut surface will be exposed, human safety and insulation countermeasures between adjacent products must be ensured. Such countermeasures include using isolation plate model P2RV-P3.1ST or taking an equivalent insulation countermeasure.

Isolation plate: P2RV-P3.1ST



**Product discontinuation  
Model P2RVC-8 series**

**P2RVC-8-I-5, P2RVC-8-I-5-1  
P2RVC-8-O-5, P2RVC-8-O-5-1**

Not compatible

**\*These cannot use the G2RV-ST/G3RV-ST**

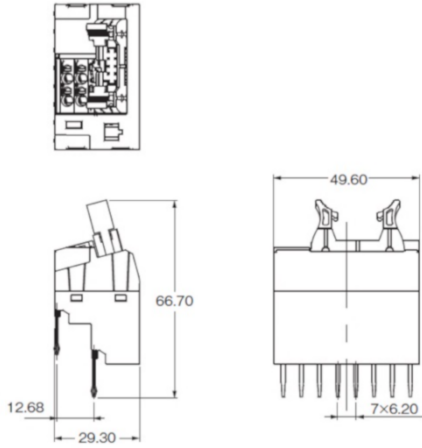

**P2RVC-8-I-7-1, P2RVC-8-O-7-1**

Not compatible

**\*These cannot use the G2RV-ST/G3RV-ST**

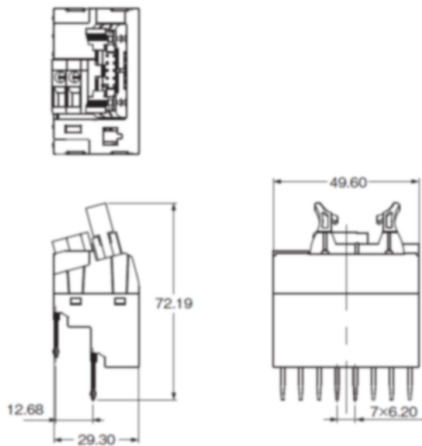

**Recommendable replacement  
Model P2RVC-8ST series**

**P2RVC-8ST-I-5, P2RVC-8ST-I-5-1  
P2RVC-8ST-O-5 P2RVC-8ST-O-5-1**

Not compatible

**\*These cannot use the G2RV-SR/G3RV-SR**

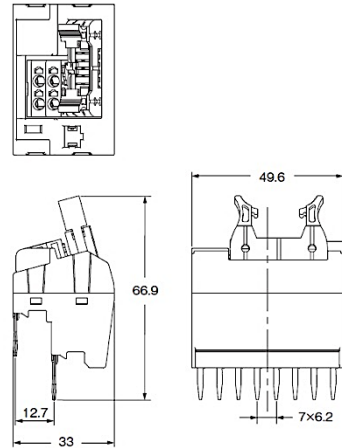

**P2RVC-8ST-I-7-1, P2RVC-8ST-O-7-1**





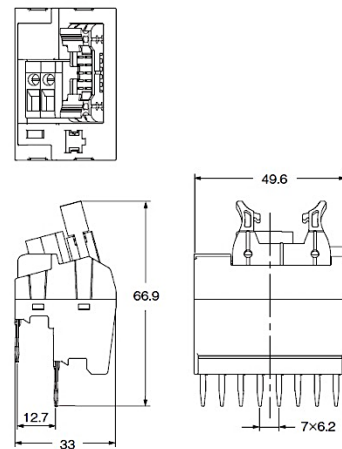

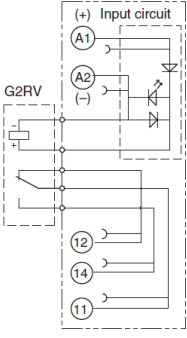
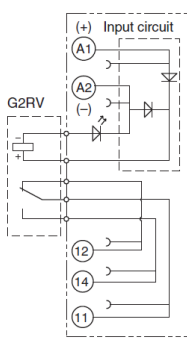
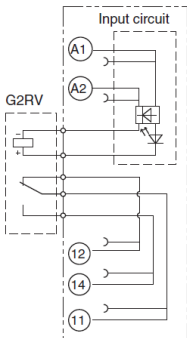

Not compatible

**\*These cannot use the G2RV-SR/G3RV-SR**

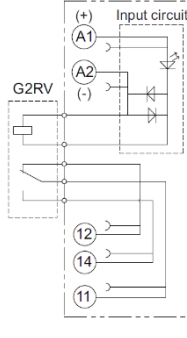
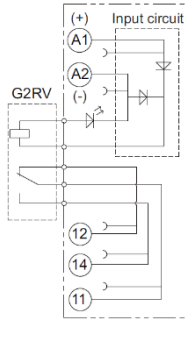
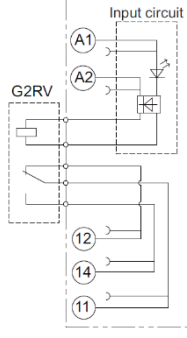

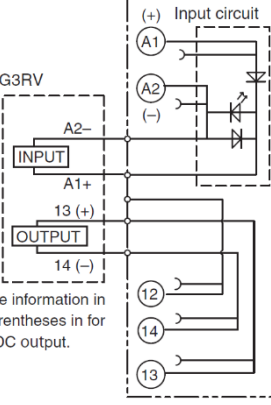
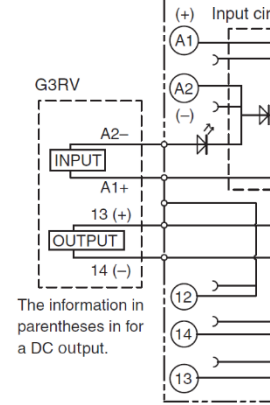
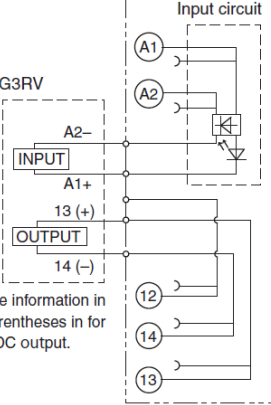

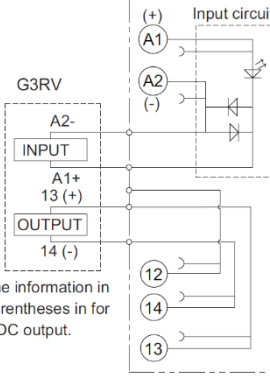
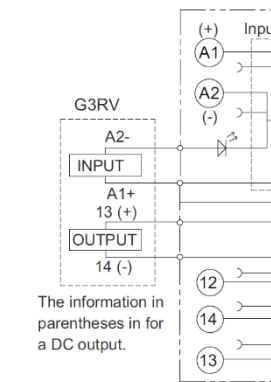
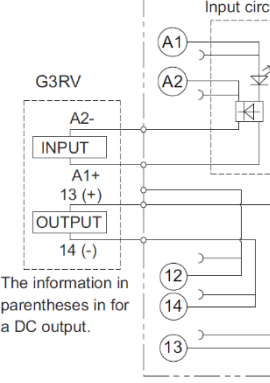
[ Wire connection ]

<p align="center"><b>Product discontinuation</b>  <b>Model G2RV-SR series</b>  <b>Model G3RV-SR series</b></p>	<p align="center"><b>Recommendable replacement</b>  <b>Model G2RV-ST series</b>  <b>Model G3RV-ST series</b></p>
<p><b>G2RV-SR500, G2RV-SR500-AP, G2RV-SR501</b>  <b>G2RV-SR700, G2RV-SR700-AP, G2RV-SR701</b></p> <div style="display: flex; justify-content: space-around;"> <div data-bbox="172 387 263 416"> <p><b>DC12V</b></p>  </div> <div data-bbox="395 387 486 416"> <p><b>DC24V</b></p>  </div> <div data-bbox="608 387 783 416"> <p><b>Other voltage</b></p>  </div> </div> <div style="text-align: center; margin-top: 10px;">  : Diode bridge   : Light emitting diode         </div>	<p><b>G2RV-ST500, G2RV-ST500-AP, G2RV-ST501</b>  <b>G2RV-ST700, G2RV-ST700-AP, G2RV-ST701</b></p> <div style="text-align: right; border: 1px solid black; padding: 2px; margin-bottom: 10px;">Compatible</div> <div style="display: flex; justify-content: space-around;"> <div data-bbox="858 387 949 416"> <p><b>DC12V</b></p>  </div> <div data-bbox="1082 387 1173 416"> <p><b>DC24V</b></p>  </div> <div data-bbox="1294 387 1469 416"> <p><b>Other voltage</b></p>  </div> </div> <div style="text-align: right; margin-top: 10px;"> <p>Equipped with a coil surge absorption circuit as standard.</p>  : Diode bridge   : Light emitting diode         </div>
<p><b>G3RV-SR500-A, G3RV-SR500-AL, G3RV-SR500-D</b></p> <div style="display: flex; justify-content: space-around;"> <div data-bbox="215 1019 306 1048"> <p><b>DC12V</b></p>  <p>The information in parentheses in for a DC output.</p> </div> <div data-bbox="507 1019 598 1048"> <p><b>DC24V</b></p>  <p>The information in parentheses in for a DC output.</p> </div> </div> <div data-bbox="215 1489 391 1518"> <p><b>Other voltage</b></p>  <p>The information in parentheses in for a DC output.</p> </div> <div style="text-align: center; margin-top: 10px;">  : Diode bridge   : Light emitting diode         </div>	<p><b>G3RV-ST500-A, G3RV-ST500-AL, G3RV-ST500-D</b></p> <div style="text-align: right; border: 1px solid black; padding: 2px; margin-bottom: 10px;">Compatible</div> <div style="display: flex; justify-content: space-around;"> <div data-bbox="890 1019 981 1048"> <p><b>DC12V</b></p>  <p>The information in parentheses in for a DC output.</p> </div> <div data-bbox="1182 1019 1273 1048"> <p><b>DC24V</b></p>  <p>The information in parentheses in for a DC output.</p> </div> </div> <div data-bbox="890 1489 1066 1518"> <p><b>Other voltage</b></p>  <p>The information in parentheses in for a DC output.</p> </div> <div style="text-align: right; margin-top: 10px;"> <p>Equipped with a coil surge absorption circuit as standard.</p>  : Diode bridge   : Light emitting diode         </div>

[ Wire connection ] Continue

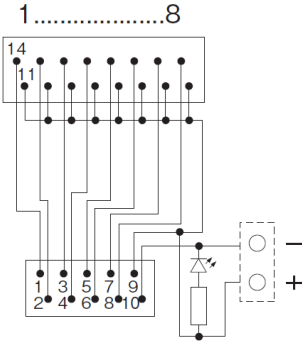
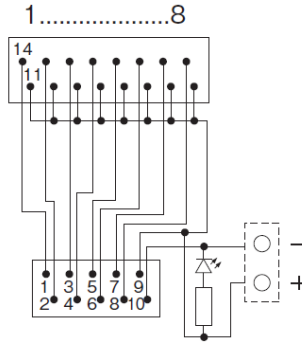
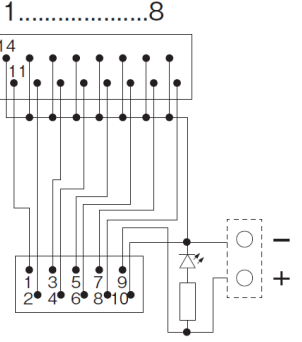
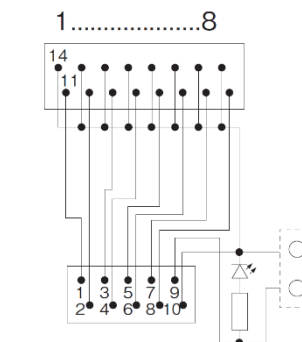
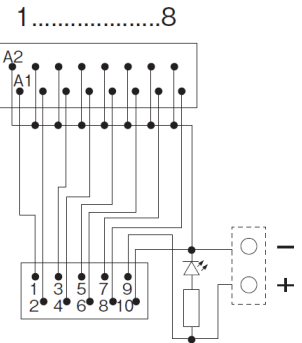
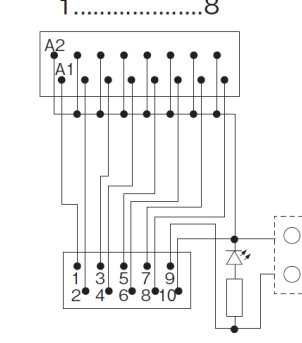
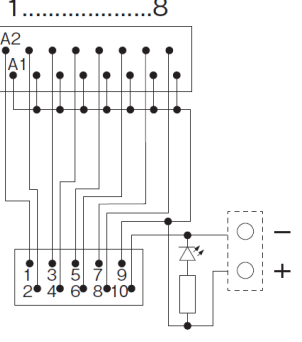
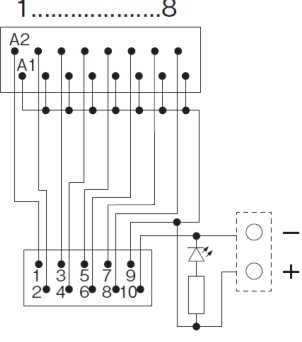
Product discontinuation Model P2RVC-8 series	Recommendable replacement Model P2RVC-8ST series
<p><b>P2RVC-8-I-5-1, P2RVC-8-I-7-1</b></p> 	<p><b>P2RVC-8ST-I-5-1, P2RVC-8ST-I-7-1</b></p> <div style="border: 1px solid black; padding: 2px; display: inline-block;">Compatible</div> 
<p><b>P2RVC-8-I-5</b></p> 	<p><b>P2RVC-8ST-I-5</b></p> <div style="border: 1px solid black; padding: 2px; display: inline-block;">Compatible</div> 
<p><b>P2RVC-8-O-5-1, P2RVC-8-O-7-1</b></p> 	<p><b>P2RVC-8ST-O-5-1, P2RVC-8ST-O-7-1</b></p> <div style="border: 1px solid black; padding: 2px; display: inline-block;">Compatible</div> 
<p><b>P2RVC-8-O-5</b></p> 	<p><b>P2RVC-8ST-O-5</b></p> <div style="border: 1px solid black; padding: 2px; display: inline-block;">Compatible</div> 

[ Characteristics ] G2RV series  
There is no change

Compatible

[ Characteristics ] G3RV series

Not compatible

Item		Product discontinuation Model G3RV-SR series	Recommendable replacement Model G3RV-ST series
Release time	-A type	60ms max.	31ms max. (1/2 cycle of load power supply + 1ms + 1 cycle of input power supply frequency)
	-AL type	60ms max.	31ms max. (1/2 cycle of load power supply + 1ms + 1 cycle of input power supply frequency)
	-D type	60ms max.	21ms max. (1ms + 1 cycle of input power supply frequency)
Load current vs. ambient temperature	-A type -AL type	<p>Close mounting (up to 5 units)</p>	<p>Close mounting (up to 8 units)</p>
	-D type	<p>Close mounting (up to 5 units)</p>	<p>Close mounting (up to 8 units)</p>

[ Characteristics ] PYDN-6.2ST series  
There is no change

Compatible

Almost compatible

[ Characteristics ] P2RVC-8ST series

Item	Product discontinuation Model P2RVC-8 series	Recommendable replacement Model P2RVC-8ST series
<b>Vibration resistance</b>	Destruction: Frequency 10~55~10Hz Single amplitude 0.75mm Malfunction: Frequency 10~55~10Hz Single amplitude 0.75mm	Destruction: Frequency 10~55~10Hz Single amplitude 0.50mm Malfunction: Frequency 10~55~10Hz Single amplitude 0.50mm

Unification of the specification to Relay model G2RV-ST series.

Replacement model P2RVC-8ST are designed to have the same or more actual specification than discontinuation model P2RVC-8 series.

<Reference information>

There is no change between G2RV-SR and G2RV-ST series on Vibration resistance.

Item	Product discontinuation Model G2RV-SR series	Recommendable replacement Model G2RV-ST series
<b>Vibration resistance</b>	Destruction: Frequency 10~55~10Hz Single amplitude 0.50mm Malfunction: Frequency 10~55~10Hz Single amplitude 0.50mm	Destruction: Frequency 10~55~10Hz Single amplitude 0.50mm Malfunction: Frequency 10~55~10Hz Single amplitude 0.50mm

Almost compatible





[ Operation ratings ]



Product discontinuation Model G2RV-SR series Model G3RV-SR series				Recommendable replacement Model G2RV-ST series Model G3RV-ST series			
<b>Wire size</b> Stranded wire, Solid wire				<b>Wire size</b> Stranded wire, Solid wire			
<b>G2RV-SR/G3RV-SR series</b>				<b>G2RV-ST/G3RV-ST series</b>			
<b>Applicable wire size</b>		<b>Stripping length</b>		<b>Applicable wire size</b>		<b>Stripping length</b>	
0.5~1.5mm <sup>2</sup> AWG20~16		8 mm		0.5~2.5mm <sup>2</sup> AWG20~14		8~10 mm	
<b>Ferrules used</b>				<b>Recommended ferrules</b>			
G2RV-SR500, G2RV-SR500-AP, G2RV-SR501 G3RV-SR500-A, G3RV-SR500-AP, G3RV-SR500-D				G2RV-ST500, G2RV-ST500-AP, G2RV-ST501 G3RV-ST500-A, G3RV-ST500-AP, G3RV-ST500-D			
<b>Applicable wire</b>		<b>Ferrules Conduct length (mm)</b>	<b>Stripping Length (mm) (Ferrules used)</b>	<b>Applicable wire</b>		<b>Ferrules Conduct length (mm)</b>	<b>Stripping Length (mm) (Ferrules used)</b>
(mm <sup>2</sup> )	(AWG)			(mm <sup>2</sup> )	(AWG)		
0.25	24	8	10	0.25	24	8	10
		10	12			10	12
0.34	22	8	10	0.34	22	8	10
		10	12			10	12
0.5	20	8	10	0.5	20	8	10
		10	12			10	12
0.75	18	8	10	0.75	18	8	10
		10	12			10	12
1/1.25	18/17	8	10	1/1.25	18/17	8	10
		10	12			10	12
1.25/1.5	17/16	8	10	1.25/1.5	17/16	8	10
		10	12			10	12
				2.0/2.5	14	10	12
G2RV-SR700, G2RV-SR700-AP, G2RV-SR701							

Product discontinuation Model G2RV-SR series Model G3RV-SR series			Recommendable replacement Model G2RV-ST series Model G3RV-ST series		
G3RV-SR700-A, G3RV-SR700-AP, G3RV-SR700-D			G2RV-ST700, G2RV-ST700-AP, G2RV-ST701 G3RV-ST700-A, G3RV-ST700-AP, G3RV-ST700-D		
Wired type	Applicable wire size	Stripping length	Wired type	Applicable wire size	Stripping length
Stranded wires, without ferrule	0.5~1.5 mm <sup>2</sup>	8mm	Stranded wires, without ferrule	0.5~2.5 mm <sup>2</sup>	8~10 mm
Stranded wires, with ferrule and plastic collar			Stranded wires, with ferrule and plastic collar		
Stranded wires with ferrule, without plastic collar			Stranded wires with ferrule, without plastic collar		
Single wire			Single wire		

[ Other ]

Not compatible

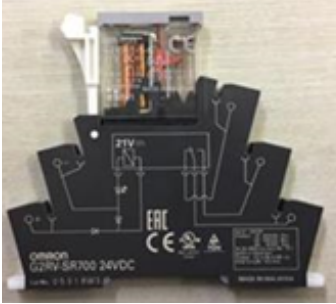
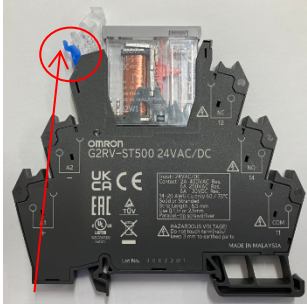
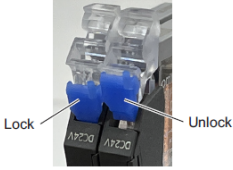
Product discontinuation Model G2RV-SR series Model G3RV-SR series	Recommendable replacement Model G2RV-ST series Model G3RV-ST series
<p>Mounting method on the DIN track. Structure: Double fixture rail.</p> <ol style="list-style-type: none"> <li>① Open the fixture rail.</li> <li>② Set on the DIN track.</li> <li>③ Close the fixture rail.</li> </ol> <div style="display: flex; justify-content: space-around;"> <div style="text-align: center;"> <p>①</p>  <p>Fixture rail</p> </div> <div style="text-align: center;"> <p>②</p>  </div> </div> <div style="text-align: center; margin-top: 10px;"> <p>③</p>  </div> <p>Holding method the mounted relay.</p>	<p>Mounting method on the DIN track. Structure: Integration of fixture rail and molding product.</p> <ol style="list-style-type: none"> <li>① Attach point A on the DIN track.</li> <li>② Attach the opposite side of point A on the DIN track.</li> </ol> <div style="display: flex; justify-content: space-around;"> <div style="text-align: center;"> <p>①</p>  <p>Point A</p> </div> <div style="text-align: center;"> <p>②</p>  </div> </div> <p>Holding method the mounted relay.</p>

<b>Product discontinuation</b> <b>Model G2RV-SR series</b> <b>Model G3RV-SR series</b>	<b>Recommendable replacement</b> <b>Model G2RV-ST series</b> <b>Model G3RV-ST series</b>
<p><b>There is no locking structure.</b></p> 	<p><b>Lock structure by color stopper.</b>  <b>By locking the color stopper, even if the release lever is touched unintentionally, the relay is hard come out.</b></p>   <p><b>Stopper</b></p> <p><b>Stopper color: Coil voltage line identification</b></p>  <p><b>Red: AC</b>  <b>Blue: DC</b>  <b>White: Multi (e.g. 24VAC/VDC)</b></p>

Specifications and prices in this product news are as of the issue date and are subject to change without notice. Only main changes in specifications are described in this document. Please be sure to read the relevant catalogs, datasheets, product specifications, instructions, and manuals for precautions and necessary information when using products.