

NO: PX-092
DATE: April 2021

PRODUCT: E2A
TYPE: Discontinuation Notice

Discontinuation Notice of Proximity sensor some of model E2A series.

Product Discontinuation

Proximity sensor

Model E2A Series



Recommended Replacement

Proximity sensor

Model E2E-Next Series



[Final order entry date]

The end of March 2022.

[Date of The Last Shipping]

The end of June 2022

[Scheduled date of maintenance close]

The end of March 2022

[Caution on recommended replacement]

E2E-Next series has the "I/O-Link" connection method.

[Difference from discontinued product]

Recommended replacement Model	Body Color	Dimensions	Wire connection	Mounting Dimensions	Characteristics	Operation ratings	Operation methods
E2E Next series	*	*	*	**	*	*	-

** : Compatible

* : The change is a little/Almost compatible

-- : Not compatible

- : No corresponding specification

[The models that will not be discontinued.]

The part of E2A series will not discontinued in Mar.2022 (Check Table.2 in Page 22~)

[Product Discontinuation and recommended replacement.]
As following table E2A product will be discontinued in Mar.2022.

Note:

In many cases, there are two recommended replacement products for one discontinuation product due to the different versions of the I / O link.

Table.1

Product Code	Product discontinuation	Product Code	Recommended replacement
E2A 7001C	E2A-M12KS04-WP-B1 2M	E2EN0876E	E2E-X4B1T12 2M
E2A 7002A	E2A-M12KN08-WP-B1 2M	E2EN0953B	E2E-X8MB1T12 2M
E2A 7003M	E2A-M18KS08-WP-B1 2M	E2EN1494C	E2E-X8B1T18 2M
E2A 7004H	E2A-M18KN16-WP-B1 2M	E2EN1571M	E2E-X16MB1T18 2M
E2A 7005F	E2A-M30KS15-WP-B1 2M	E2EN2068D	E2E-X15B1T30 2M
E2A 7006D	E2A-M30LN30-WP-B1 2M	E2EN2201F	E2E-X30MB1TL30 2M
E2A 7007B	E2A-M12KS04-WP-B1 5M	E2EN0879M	E2E-X4B1T12 5M
E2A 7008M	E2A-M12KN08-WP-B1 5M	E2EN0956G	E2E-X8MB1T12 5M
E2A 7009R	E2A-M18KS08-WP-B1 5M	E2EN1497H	E2E-X8B1T18 5M
E2A 7010B	E2A-M18KN16-WP-B1 5M	E2EN1574E	E2E-X16MB1T18 5M
E2A 7011M	E2A-M30KS15-WP-B1 5M	E2EN2071D	E2E-X15B1T30 5M
E2A 7012R	E2A-M30LN30-WP-B1 5M	E2EN2204M	E2E-X30MB1TL30 5M
E2A 7013G	E2A-M12KS04-WP-B2 2M	E2EN0877C	E2E-X4B212 2M
E2A 7014E	E2A-M12KN08-WP-B2 2M	E2EN0954M	E2E-X8MB212 2M
E2A 7015C	E2A-M18KS08-WP-B2 2M	E2EN1495A	E2E-X8B218 2M
E2A 7016A	E2A-M18KN16-WP-B2 2M	E2EN1572R	E2E-X16MB218 2M
E2A 7017M	E2A-M30KS15-WP-B2 2M	E2EN2069B	E2E-X15B230 2M
E2A 7018H	E2A-M30LN30-WP-B2 2M	E2EN2202D	E2E-X30MB2L30 2M
E2A 7019F	E2A-M12KS04-WP-B2 5M	E2EN0880C	E2E-X4B212 5M
E2A 7020M	E2A-M12KN08-WP-B2 5M	E2EN0957E	E2E-X8MB212 5M
E2A 7021H	E2A-M18KS08-WP-B2 5M	E2EN1498F	E2E-X8B218 5M
E2A 7022F	E2A-M18KN16-WP-B2 5M	E2EN1575C	E2E-X16MB218 5M
E2A 7023D	E2A-M30KS15-WP-B2 5M	E2EN2072B	E2E-X15B230 5M
E2A 7024B	E2A-M30LN30-WP-B2 5M	E2EN2205R	E2E-X30MB2L30 5M
E2A 7025M	E2A-M12KS04-WP-C1 2M	E2EN0634G	E2E-X4C112 2M

Product Code	Product discontinuation	Product Code	Recommended replacement
E2A 7026R	E2A-M12KN08-WP-C1 2M	E2EN0711D	E2E-X8MC112 2M
E2A 7027G	E2A-M18KS08-WP-C1 2M	E2EN1272M	E2E-X8C118 2M
E2A 7028E	E2A-M18KN16-WP-C1 2M	E2EN1349A	E2E-X16MC118 2M
E2A 7029C	E2A-M30KS15-WP-C1 2M	E2EN1858B	E2E-X15C130 2M
E2A 7030G	E2A-M30LN30-WP-C1 2M	E2EN1991M	E2E-X30MC1L30 2M
E2A 7031E	E2A-M12KS04-WP-C1 5M	E2EN0637A	E2E-X4C112 5M
E2A 7032C	E2A-M12KN08-WP-C1 5M	E2EN0714R	E2E-X8MC112 5M
E2A 7033A	E2A-M18KS08-WP-C1 5M	E2EN1275D	E2E-X8C118 5M
E2A 7034M	E2A-M18KN16-WP-C1 5M	E2EN1352A	E2E-X16MC118 5M
E2A 7035H	E2A-M30KS15-WP-C1 5M	E2EN1861B	E2E-X15C130 5M
E2A 7036F	E2A-M30LN30-WP-C1 5M	E2EN1994E	E2E-X30MC1L30 5M
E2A 7037D	E2A-M12KS04-WP-C2 2M	E2EN0635E	E2E-X4C212 2M
E2A 7038B	E2A-M12KN08-WP-C2 2M	E2EN0712B	E2E-X8MC212 2M
E2A 7039M	E2A-M18KS08-WP-C2 2M	E2EN1273H	E2E-X8C218 2M
E2A 7040D	E2A-M18KN16-WP-C2 2M	E2EN1350E	E2E-X16MC218 2M
E2A 7041B	E2A-M30KS15-WP-C2 2M	E2EN1859M	E2E-X15C230 2M
E2A 7042M	E2A-M30LN30-WP-C2 2M	E2EN1992R	E2E-X30MC2L30 2M
E2A 7043R	E2A-M12KS04-WP-C2 5M	E2EN0638M	E2E-X4C212 5M
E2A 7044G	E2A-M12KN08-WP-C2 5M	E2EN0715G	E2E-X8MC212 5M
E2A 7045E	E2A-M18KS08-WP-C2 5M	E2EN1276B	E2E-X8C218 5M
E2A 7046C	E2A-M18KN16-WP-C2 5M	E2EN1353M	E2E-X16MC218 5M
E2A 7047A	E2A-M30KS15-WP-C2 5M	E2EN1862M	E2E-X15C230 5M
E2A 7048M	E2A-M30LN30-WP-C2 5M	E2EN1995C	E2E-X30MC2L30 5M
E2A 7049H	E2A-M12KS04-M1-B1	E2EN0894C	E2E-X4B1T12-M1
E2A 7050A	E2A-M12KN08-M1-B1	E2EN0971M	E2E-X8MB1T12-M1
E2A 7051M	E2A-M18KS08-M1-B1	E2EN1512E	E2E-X8B1T18-M1
E2A 7052H	E2A-M18KN16-M1-B1	E2EN1589C	E2E-X16MB1T18-M1
E2A 7053F	E2A-M30KS15-M1-B1	E2EN2086B	E2E-X15B1T30-M1
E2A 7054D	E2A-M30LN30-M1-B1	E2EN2219R	E2E-X30MB1TL30-M1
E2A 7055B	E2A-M12KS04-M1-B2	E2EN0895A	E2E-X4B212-M1

Product Code	Product discontinuation	Product Code	Recommended replacement
E2A 7056M	E2A-M12KN08-M1-B2	E2EN0972R	E2E-X8MB212-M1
E2A 7057R	E2A-M18KS08-M1-B2	E2EN1513C	E2E-X8B218-M1
E2A 7058G	E2A-M18KN16-M1-B2	E2EN1590G	E2E-X16MB218-M1
E2A 7059E	E2A-M30KS15-M1-B2	E2EN2087M	E2E-X15B230-M1
E2A 7060R	E2A-M30LN30-M1-B2	E2EN2220B	E2E-X30MB2L30-M1
E2A 7061G	E2A-M12KS04-M1-C1	E2EN0652E	E2E-X4C112-M1
E2A 7062E	E2A-M12KN08-M1-C1	E2EN0729G	E2E-X8MC112-M1
E2A 7063C	E2A-M18KS08-M1-C1	E2EN1290H	E2E-X8C118-M1
E2A 7064A	E2A-M18KN16-M1-C1	E2EN1367M	E2E-X16MC118-M1
E2A 7065M	E2A-M30KS15-M1-C1	E2EN1876M	E2E-X15C130-M1
E2A 7066H	E2A-M30LN30-M1-C1	E2EN2009R	E2E-X30MC1L30-M1
E2A 7067F	E2A-M12KS04-M1-C2	E2EN0653C	E2E-X4C212-M1
E2A 7068D	E2A-M18KS08-M1-C2	E2EN1291F	E2E-X8C218-M1
E2A 7069B	E2A-M12KN08-M1-C2	E2EN0730M	E2E-X8MC212-M1
E2A 7070F	E2A-M18KN16-M1-C2	E2EN1368H	E2E-X16MC218-M1
E2A 7071D	E2A-M30KS15-M1-C2	E2EN1877R	E2E-X15C230-M1
E2A 7072B	E2A-M30LN30-M1-C2	E2EN2010B	E2E-X30MC2L30-M1
E2A 7085D	E2A-M12LN08-M1-B1	E2EN1074C	E2E-X8MB1TL12-M1
E2A 7086B	E2A-M12LN08-M1-B2	E2EN1075A	E2E-X8MB2L12-M1
E2A 7087M	E2A-M12LN08-M1-C1	E2EN0832C	E2E-X8MC1L12-M1
E2A 7088R	E2A-M12LN08-M1-C2	E2EN0833A	E2E-X8MC2L12-M1
E2A 7089G	E2A-M12LN08-WP-B1 2M	E2EN1065D	E2E-X8MB1TL12 2M
E2A 7090M	E2A-M12LN08-WP-B1 5M	E2EN1068R	E2E-X8MB1TL12 5M
E2A 7091R	E2A-M12LN08-WP-B2 2M	E2EN1066B	E2E-X8MB2L12 2M
E2A 7092G	E2A-M12LN08-WP-B2 5M	E2EN1069G	E2E-X8MB2L12 5M
E2A 7093E	E2A-M12LN08-WP-C1 2M	E2EN0823D	E2E-X8MC1L12 2M
E2A 7094C	E2A-M12LN08-WP-C1 5M	E2EN0826R	E2E-X8MC1L12 5M
E2A 7095A	E2A-M12LN08-WP-C2 2M	E2EN0824B	E2E-X8MC2L12 2M
E2A 7096M	E2A-M12LN08-WP-C2 5M	E2EN0827G	E2E-X8MC2L12 5M
E2A 7097H	E2A-M12LS04-M1-B1	E2EN1209F	E2E-X4B1DL12-M1

Product Code	Product discontinuation	Product Code	Recommended replacement
E2A 7098F	E2A-M12LS04-M1-B2	E2EN1031M	E2E-X4B2L12-M1
E2A 7099D	E2A-M12LS04-M1-C1	E2EN0788B	E2E-X4C1L12-M1
E2A 7100A	E2A-M12LS04-M1-C2	E2EN0789M	E2E-X4C2L12-M1
E2A 7101M	E2A-M12LS04-WP-B1 2M	E2EN1021B	E2E-X4B1TL12 2M
E2A 7102H	E2A-M12LS04-WP-B1 5M	E2EN1024G	E2E-X4B1TL12 5M
E2A 7103F	E2A-M12LS04-WP-B2 2M	E2EN1022M	E2E-X4B2L12 2M
E2A 7104D	E2A-M12LS04-WP-B2 5M	E2EN1025E	E2E-X4B2L12 5M
E2A 7105B	E2A-M12LS04-WP-C1 2M	E2EN0779C	E2E-X4C1L12 2M
E2A 7106M	E2A-M12LS04-WP-C1 5M	E2EN0782C	E2E-X4C1L12 5M
E2A 7107R	E2A-M12LS04-WP-C2 2M	E2EN0780G	E2E-X4C2L12 2M
E2A 7108G	E2A-M12LS04-WP-C2 5M	E2EN0783A	E2E-X4C2L12 5M
E2A 7109E	E2A-M18LN16-M1-B1	E2EN1657A	E2E-X16MB1TL18-M1
E2A 7110R	E2A-M18LN16-M1-B2	E2EN1658M	E2E-X16MB2L18-M1
E2A 7111G	E2A-M18LN16-M1-C1	E2EN1435H	E2E-X16MC1L18-M1
E2A 7112E	E2A-M18LN16-M1-C2	E2EN1436F	E2E-X16MC2L18-M1
E2A 7113C	E2A-M18LN16-WP-B1 2M	E2EN1648B	E2E-X16MB1TL18 2M
E2A 7114A	E2A-M18LN16-WP-B1 5M	E2EN1651B	E2E-X16MB1TL18 5M
E2A 7115M	E2A-M18LN16-WP-B2 2M	E2EN1649M	E2E-X16MB2L18 2M
E2A 7116H	E2A-M18LN16-WP-B2 5M	E2EN1652M	E2E-X16MB2L18 5M
E2A 7117F	E2A-M18LN16-WP-C1 2M	E2EN1426R	E2E-X16MC1L18 2M
E2A 7118D	E2A-M18LN16-WP-C1 5M	E2EN1429C	E2E-X16MC1L18 5M
E2A 7119B	E2A-M18LN16-WP-C2 2M	E2EN1427G	E2E-X16MC2L18 2M
E2A 7120F	E2A-M18LN16-WP-C2 5M	E2EN1430G	E2E-X16MC2L18 5M
E2A 7121D	E2A-M18LS08-M1-B1	E2EN1613M	E2E-X8B1TL18-M1
E2A 7122B	E2A-M18LS08-M1-B2	E2EN1614H	E2E-X8B2L18-M1
E2A 7123M	E2A-M18LS08-M1-C1	E2EN1391B	E2E-X8C1L18-M1
E2A 7124R	E2A-M18LS08-M1-C2	E2EN1392M	E2E-X8C2L18-M1
E2A 7125G	E2A-M18LS08-WP-B1 2M	E2EN1604M	E2E-X8B1TL18 2M
E2A 7126E	E2A-M18LS08-WP-B1 5M	E2EN1607E	E2E-X8B1TL18 5M
E2A 7127C	E2A-M18LS08-WP-B2 2M	E2EN1605R	E2E-X8B2L18 2M

Product Code	Product discontinuation	Product Code	Recommended replacement
E2A 7128A	E2A-M18LS08-WP-B2 5M	E2EN1608C	E2E-X8B2L18 5M
E2A 7129M	E2A-M18LS08-WP-C1 2M	E2EN1382C	E2E-X8C1L18 2M
E2A 7130C	E2A-M18LS08-WP-C1 5M	E2EN1385H	E2E-X8C1L18 5M
E2A 7131A	E2A-M18LS08-WP-C2 2M	E2EN1383A	E2E-X8C2L18 2M
E2A 7132M	E2A-M18LS08-WP-C2 5M	E2EN1386F	E2E-X8C2L18 5M
E2A 7133H	E2A-M30LS15-M1-B1	E2EN2166D	E2E-X15B1TL30-M1
E2A 7134F	E2A-M30LS15-M1-B2	E2EN2167B	E2E-X15B2L30-M1
E2A 7135D	E2A-M30LS15-M1-C1	E2EN1956B	E2E-X15C1L30-M1
E2A 7136B	E2A-M30LS15-M1-C2	E2EN1957M	E2E-X15C2L30-M1
E2A 7137M	E2A-M30LS15-WP-B1 2M	E2EN2157E	E2E-X15B1TL30 2M
E2A 7138R	E2A-M30LS15-WP-B1 5M	E2EN2160E	E2E-X15B1TL30 5M
E2A 7139G	E2A-M30LS15-WP-B2 2M	E2EN2158C	E2E-X15B2L30 2M
E2A 7140M	E2A-M30LS15-WP-B2 5M	E2EN2161C	E2E-X15B2L30 5M
E2A 7141R	E2A-M30LS15-WP-C1 2M	E2EN1947C	E2E-X15C1L30 2M
E2A 7142G	E2A-M30LS15-WP-C1 5M	E2EN1950C	E2E-X15C1L30 5M
E2A 7143E	E2A-M30LS15-WP-C2 2M	E2EN1948A	E2E-X15C2L30 2M
E2A 7144C	E2A-M30LS15-WP-C2 5M	E2EN1951A	E2E-X15C2L30 5M
E2A 7192C	E2A-M08KN04-M1-B1	E2EN0540E	E2E-X4MB1D8-M1
E2A 7193A	E2A-M08KS02-M1-C1	E2EN0031D	E2E-X2C18-M1
E2A 7194M	E2A-M08LN04-M1-C1	E2EN0214G	E2E-X4MC1L8-M1
E2A 7195H	E2A-M08LS02-M1-B2	E2EN0409C	E2E-X2B2L8-M1
E2A 7208C	E2A-M08KN04-M1-B2	E2EN0348H	E2E-X4MB28-M1
E2A 7209A	E2A-M08KN04-M1-C1	E2EN0103E	E2E-X4MC18-M1
E2A 7210E	E2A-M08KN04-M1-C2	E2EN0104C	E2E-X4MC28-M1
E2A 7211C	E2A-M08KS02-M1-B1	E2EN0504R	E2E-X2B1D8-M1
E2A 7212A	E2A-M08KS02-M1-B2	E2EN0276G	E2E-X2B28-M1
E2A 7213M	E2A-M08KS02-M1-C2	E2EN0032B	E2E-X2C28-M1
E2A 7214H	E2A-M08LN04-M1-B1	E2EN0597R	E2E-X4MB1DL8-M1
E2A 7215F	E2A-M08LN04-M1-B2	E2EN0459M	E2E-X4MB2L8-M1
E2A 7216D	E2A-M08LN04-M1-C2	E2EN0215E	E2E-X4MC2L8-M1

Product Code	Product discontinuation	Product Code	Recommended replacement
E2A 7217B	E2A-M08LS02-M1-B1	E2EN0571E	E2E-X2B1DL8-M1
E2A 7218M	E2A-M08LS02-M1-C1	E2EN0164G	E2E-X2C1L8-M1
E2A 7219R	E2A-M08LS02-M1-C2	E2EN0165E	E2E-X2C2L8-M1
E2A 7275M	E2A-M12KN05-WP-B1 5M	E2EN0935D	E2E-X5MB1T12 5M
E2A 7276H	E2A-M12LN05-WP-B1 5M	E2EN1056E	E2E-X5MB1TL12 5M
E2A 7285G	E2A-M12KN05-M1-B1	E2EN0950H	E2E-X5MB1T12-M1
E2A 7286E	E2A-M12KN05-WP-B1 2M	E2EN0932M	E2E-X5MB1T12 2M
E2A 7287C	E2A-M12KS02-M1-B1	E2EN0873M	E2E-X2B1T12-M1
E2A 7288A	E2A-M12KS02-WP-B1 2M	E2EN0855B	E2E-X2B1T12 2M
E2A 7289M	E2A-M18KN10-M1-B1	E2EN1568M	E2E-X10MB1T18-M1
E2A 7290C	E2A-M18KN10-WP-B1 5M	E2EN1553B	E2E-X10MB1T18 5M
E2A 7291A	E2A-M18KS05-WP-B1 2M	E2EN1473M	E2E-X5B1T18 2M
E2A 7297M	E2A-M12KS02-WP-B1 5M	E2EN0858G	E2E-X2B1T12 5M
E2A 7299G	E2A-M12KS02-WP-C1 5M	E2EN0616R	E2E-X2C112 5M
E2A 7300D	E2A-M12LS02-WP-B1 5M	E2EN1012C	E2E-X2B1TL12 5M
E2A 7320R	E2A-M30LS15-WP-B3 5M	E2EN2331D	E2E-X15B3DL30 5M
E2A 7321G	E2A-M18KS08-M1-B3	E2EN1722E	E2E-X8B3D18-M1
E2A 7326H	E2A-M18KS08-WP-B3	E2EN1710A	E2E-X8B3D18 2M
E2A 7327F	E2A-M12LN05-M1-B1	E2EN1062M	E2E-X5MB1TL12-M1
E2A 7328D	E2A-M12LS02-M1-B1	E2EN1018B	E2E-X2B1TL12-M1
E2A 7330F	E2A-M12LS04-WS-B1 2M	E2EN1203G	E2E-X4B1DL12 2M
E2A 7334R	E2A-M12KS02-WP-C1 2M	E2EN0613D	E2E-X2C112 2M
E2A 7336E	E2A-M18KS05-M1-B1	E2EN1491R	E2E-X5B1T18-M1
E2A 7337C	E2A-M18LS05-M1-B1	E2EN1601F	E2E-X5B1TL18-M1
E2A 7341A	E2A-M12KS04-M1-B3	E2EN1124C	E2E-X4B3D12-M1
E2A 7342M	E2A-M12LS04-M1-B3	E2EN1210M	E2E-X4B3DL12-M1
E2A 7343H	E2A-M18KN16-M1-B3	E2EN1771C	E2E-X16MB3D18-M1
E2A 7344F	E2A-M18LS08-M1-B3	E2EN1787M	E2E-X8B3DL18-M1
E2A 7345D	E2A-M30KS15-M1-B3	E2EN2284R	E2E-X15B3D30-M1
E2A 7346B	E2A-M30LS15-M1-B3	E2EN2335G	E2E-X15B3DL30-M1

Product Code	Product discontinuation	Product Code	Recommended replacement
E2A 7400M	E2A-M18KS08-WS-B1 5M	E2EN1711M	E2E-X8B1D18 5M
E2A 7412D	E2A-M12KS04-WA-B1 5M	E2EN1113H	E2E-X4B1D12 5M
E2A 7419A	E2A-M30KS10-M1-B1	E2EN2065M	E2E-X10B1T30-M1
A 7431M	E2A-M18KS05-M1-C1	E2EN1269M	E2E-X5C118-M1
E2A 7432R	E2A-M12KS02-M1-B2	E2EN0874R	E2E-X2B212-M1
E2A 7433G	E2A-M18KS05-WP-C1 2M	E2EN1251G	E2E-X5C118 2M
E2A 7443D	E2A-M30KS15-WS-C1 2M	E2EN1858B	E2E-X15C130 2M
E2A 7479E	E2A-M12KN08-WR-B1 2M	E2EN1160M	E2E-X8MB1D12 2M
E2A 7486H	E2A-M30KS10-WP-B1 2M	E2EN2047A	E2E-X10B1T30 2M
E2A 7494R	E2A-M12KN05-WP-C1 2M	E2EN0690H	E2E-X5MC112 2M
E2A 7534A	E2A-M12KS04-WP-B3 2M	E2EN1112M	E2E-X4B3D12 2M
E2A 7535M	E2A-M12KN08-WP-B3 2M	E2EN1161H	E2E-X8MB3D12 2M
E2A 7536H	E2A-M12LN08-M1-B3	E2EN1238M	E2E-X8MB3DL12-M1
E2A 7537F	E2A-M12KN08-M1-B3	E2EN1173A	E2E-X8MB3D12-M1
E2A 7538D	E2A-M18LN16-M1-B3	E2EN1815R	E2E-X16MB3DL18-M1
E2A 7539B	E2A-M30LS15-WP-B3 2M	E2EN2329B	E2E-X15B3DL30 2M
E2A 7540F	E2A-M30LN30-M1-B3	E2EN2369A	E2E-X30MB3DL30-M1
E2A 7542B	E2A-M18KS08-WP-B3 5M	E2EN1712H	E2E-X8B3D18 5M
E2A 7543M	E2A-M12LS04-WP-B3 5M	E2EN1206A	E2E-X4B3DL12 5M
E2A 7545G	E2A-M12KN05-M1-B3	E2EN1159F	E2E-X5MB3D12-M1
E2A 7546E	E2A-M12LS04-WP-B3 2M	E2EN1204E	E2E-X4B3DL12 2M
E2A 7547C	E2A-M12LN08-WP-B3 2M	E2EN1232M	E2E-X8MB3DL12 2M
E2A 7548A	E2A-M18LS08-WP-B3 2M	E2EN1781M	E2E-X8B3DL18 2M
E2A 7549M	E2A-M18LN16-WP-B3 2M	E2EN1809D	E2E-X16MB3DL18 2M
E2A 7550C	E2A-M18KN16-WP-B3 2M	E2EN1759D	E2E-X16MB3D18 2M
E2A 7551A	E2A-M30KS15-WP-B3 2M	E2EN2272E	E2E-X15B3D30 2M
E2A 7552M	E2A-M30LN30-WP-B3 2M	E2EN2357H	E2E-X30MB3DL30 2M
E2A 7555D	E2A-M12LS04-WP-C3 2M	E2EN0781E	E2E-X4C3L12 2M
E2A 7556B	E2A-M12KS04-WP-C3 2M	E2EN0636C	E2E-X4C312 2M
E2A 7557M	E2A-M12LS04-M1-C3	E2EN0790D	E2E-X4C3L12-M1

Product Code	Product discontinuation	Product Code	Recommended replacement
E2A 7558R	E2A-M12KS04-M1-C3	E2EN0654A	E2E-X4C312-M1
E2A 7559G	E2A-M12LN08-WP-C3 2M	E2EN0825M	E2E-X8MC3L12 2M
E2A 7560M	E2A-M12KN08-WP-C3 2M	E2EN0713M	E2E-X8MC312 2M
E2A 7561R	E2A-M12LN08-M1-C3	E2EN0834M	E2E-X8MC3L12-M1
E2A 7562G	E2A-M12KN08-M1-C3	E2EN0731R	E2E-X8MC312-M1
E2A 7563E	E2A-M18LS08-WP-C3 2M	E2EN1384M	E2E-X8C3L18 2M
E2A 7564C	E2A-M18KS08-WP-C3 2M	E2EN1274F	E2E-X8C318 2M
E2A 7565A	E2A-M18LS08-M1-C3	E2EN1393R	E2E-X8C3L18-M1
E2A 7566M	E2A-M18KS08-M1-C3	E2EN1292D	E2E-X8C318-M1
E2A 7567H	E2A-M18LN16-WP-C3 2M	E2EN1428E	E2E-X16MC3L18 2M
E2A 7568F	E2A-M18KN16-WP-C3 2M	E2EN1351C	E2E-X16MC318 2M
E2A 7569D	E2A-M18LN16-M1-C3	E2EN1437D	E2E-X16MC3L18-M1
E2A 7570H	E2A-M18KN16-M1-C3	E2EN1369F	E2E-X16MC318-M1
E2A 7571F	E2A-M30LS15-WP-C3 2M	E2EN1949M	E2E-X15C3L30 2M
E2A 7572D	E2A-M30KS15-WP-C3 2M	E2EN1860D	E2E-X15C330 2M
E2A 7573B	E2A-M30LS15-M1-C3	E2EN1958R	E2E-X15C3L30-M1
E2A 7574M	E2A-M30KS15-M1-C3	E2EN1878G	E2E-X15C330-M1
E2A 7575R	E2A-M30LN30-WP-C3 2M	E2EN1993G	E2E-X30MC3L30 2M
E2A 7577E	E2A-M30LN30-M1-C3	E2EN2011M	E2E-X30MC3L30-M1
E2A 7579A	E2A-M12KS02-M1-B3	E2EN1110C	E2E-X2B3D12-M1
E2A 7587B	E2A-M12LS02-M1-C3	E2EN0778E	E2E-X2C3L12-M1
E2A 7589R	E2A-M12KS04-WP-B3 5M	E2EN1114F	E2E-X4B3D12 5M
E2A 7590B	E2A-M12KN08-WP-B3 5M	E2EN1163D	E2E-X8MB3D12 5M
E2A 7591M	E2A-M12KN05-WP-C3 2M	E2EN0692D	E2E-X5MC312 2M
E2A 7608R	E2A-M12KS02-WA-B1 5M	E2EN1099R	E2E-X2B1D12 5M
E2A 7609G	E2A-M18LS08-WA-B1 5M	E2EN1782R	E2E-X8B1DL18 5M
E2A 7625R	E2A-M12KS04-M1TJ-B3 0.3M	E2EN1120M	E2E-X4B3D12-M1TJ 0.3M
E2A 7626G	E2A-M18KS08-M1TJ-B3 0.3M	E2EN1718G	E2E-X8B3D18-M1TJ 0.3M
E2A 7627E	E2A-M30KS15-M1TJ-B3 0.3M	E2EN2280F	E2E-X15B3D30-M1TJ 0.3M

[Body color]

Product discontinuation Model E2A series	Recommendable replacement Model E2E-Next series
Metal threaded body with gray color cable	Metal threaded body with black color cable

[Wire connection]

Product discontinuation Model E2A series	Recommendable replacement Model E2E-next Series		
<p>NO(Normal Open) type PNP Type: E2A-***-B1</p> <p>Note 1: With M8 connector models, there is no output reverse polarity protection diode.</p> <p>M12 Connector Pin Arrangement (See note 2.) M8 connector (3 pin) Pin Arrangement M8 Connector (4 pin) Pin Arrangement (See note 2.)</p> <p>Note 2: Pin 2 of the M12 connector and M8 connector is not used.</p>	<p>Type: E2E-**-B1</p> <table border="1"> <tr> <td style="text-align: center;"> <p>Standard I/O mode (SIO mode) When using as a general</p> </td> <td style="text-align: center;"> <p>IO-Link Communication mode (COM mode) When using the Sensor connected to IO-Link Master Unit</p> </td> </tr> </table> <p>Its pin assignment of connector type is as same as E2A.</p>	<p>Standard I/O mode (SIO mode) When using as a general</p>	<p>IO-Link Communication mode (COM mode) When using the Sensor connected to IO-Link Master Unit</p>
<p>Standard I/O mode (SIO mode) When using as a general</p>	<p>IO-Link Communication mode (COM mode) When using the Sensor connected to IO-Link Master Unit</p>		
<p>NC (Normal Close) type PNP Type: E2A-***-B2</p> <p>Note 1: With M8 connector models, there is no output reverse polarity protection diode.</p> <p>M12 Connector Pin Arrangement (See note 2.) M8 connector (3 pin) Pin Arrangement M8 Connector (4 pin) Pin Arrangement (See note 2.)</p> <p>Note 2: Pin 4 of the M12 connector and M8 connector is not used.</p>	<p>Type: E2E-***-B2</p> <p>Note: M8 (3-pin) Connector: (1)(4)(3)</p> <p>Its pin assignment of connector type is as same as E2A.</p>		

Product discontinuation Model E2A series	Recommendable replacement Model E2E-next Series
---	--

NO+NC Type of PNP
Type: E2A-*-B3**

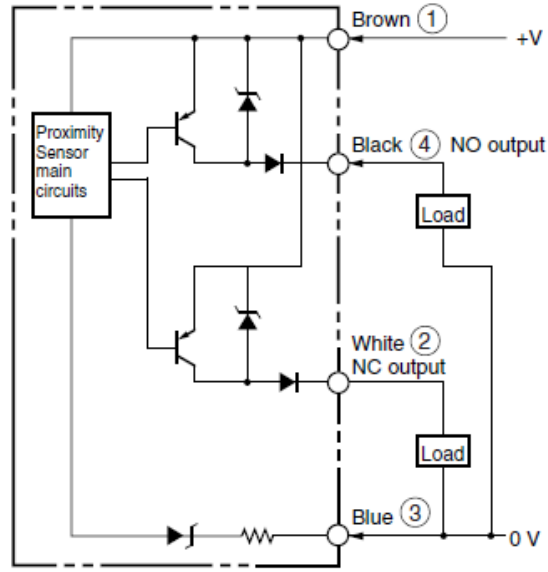

M12 Connector
Pin Arrangement

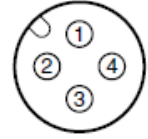

Type: E2E-*-B3**

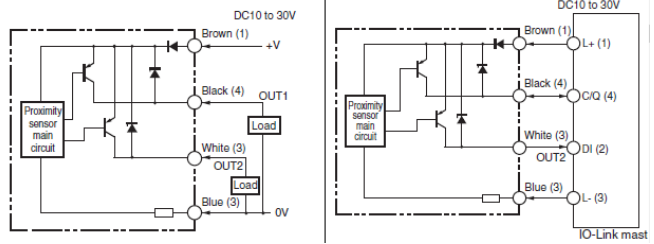

Its pin assignment of connector type is as same as E2A.

NO(Normal Open) type NPN
Type: E2A-*-C1**

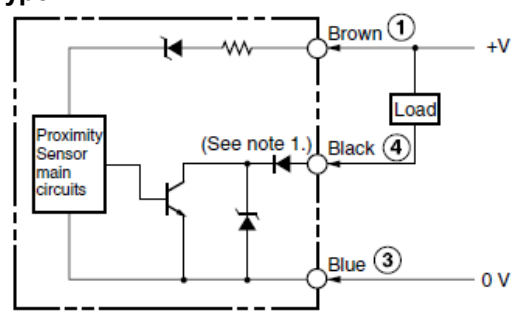

Note 1: With M8 connector models, there is no output reverse polarity protection diode.

M12 Connector Pin Arrangement (See note 2.) **M8 connector (3 pin)** Pin Arrangement **M8 Connector (4 pin)** Pin Arrangement (See note 2.)

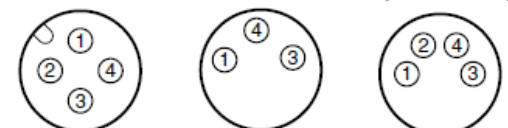

Note 2: Pin 2 of the M12 connector and M8 connector is not used.

Type: E2E-*-C1**

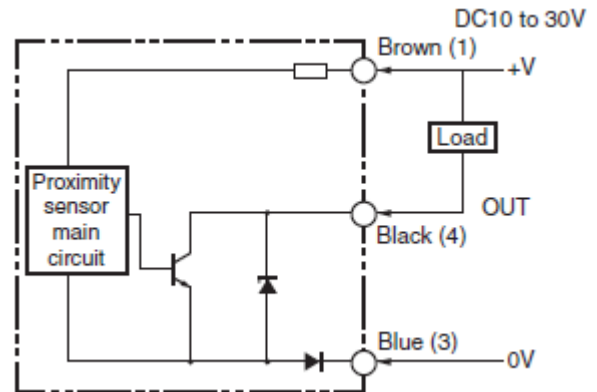

Its pin assignment of connector type is as same as E2A.

Product discontinuation Model E2A series	Recommendable replacement Model E2E-next Series
---	--

NC (Normal Close) type NPN
Type: E2A-***-C2

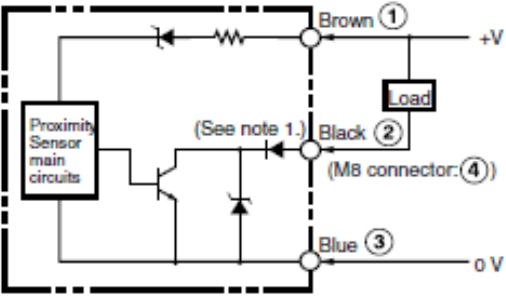

Note 1: With M8 Size Models, there is no output reverse polarity protection diode.

M12 Connector Pin Arrangement (See note 2.)
M8 Connector (3-pin) Pin Arrangement

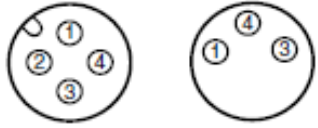

Note 2: Terminal 4 of the M12 connector is not used.

Type: E2E-***-C2

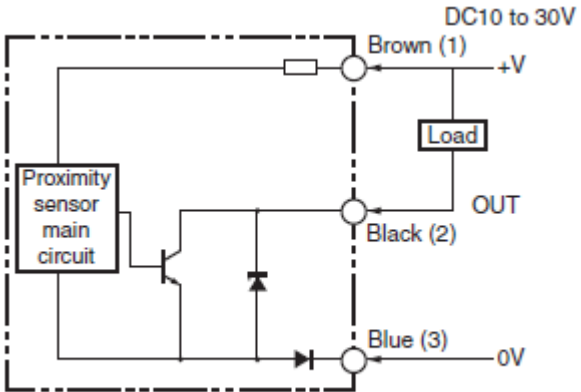

Note: M8 (3-pin) Connector: (1)(4)(3)

Its pin assignment of connector type is as same as E2A.

NO+NC Type of PNP
Type: E2A-***-C3

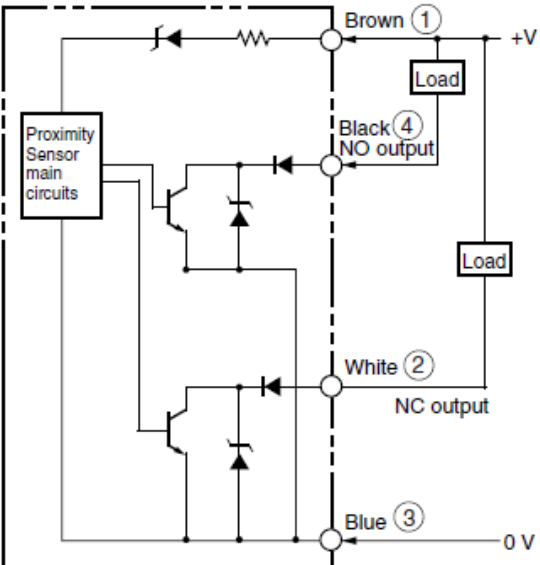

M12 Connector Pin Arrangement

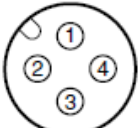

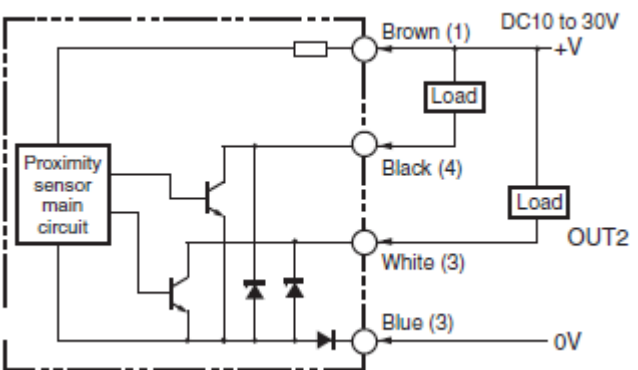

Type: E2E-***-C3

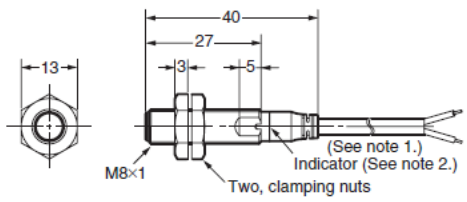
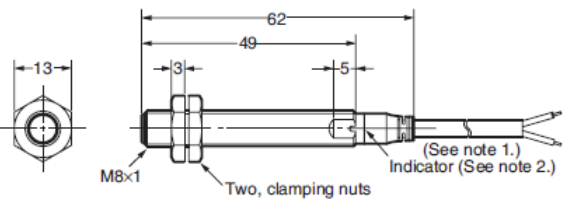
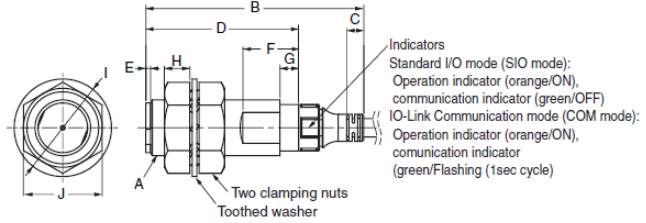

Its pin assignment of connector type is as same as E2A.

[Dimensions]

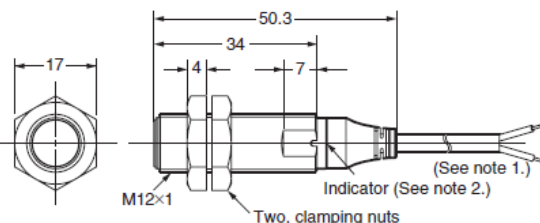
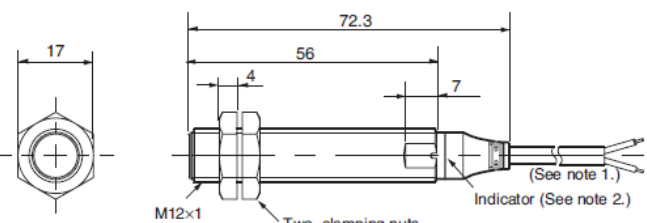
Product discontinuation Model E2A	Recommendable replacement Model E2E-Next series																																																																																																																																																																																																						
<p>M8 Pre-wired type (Shielded) E2A-S08KS02-WP-**/ E2A-S08LS02-WP-**</p>  <p>Note 1. 4-dia. vinyl-insulated round cable with 3 conductors (conductor cross section: 0.3 mm²; insulator diameter: 1.3 mm); standard length: 2 m 2. Operation indicator (yellow)</p>  <p>Note 1. 4-dia. vinyl-insulated round cable with 3 conductors (conductor cross section: 0.3 mm²; insulator diameter: 1.3 mm); standard length: 2 m 2. Operation indicator (yellow)</p>	<p>Pre-wired Models of E2E-Next series (dimension table).</p>  <p>Pre-wired Models (Operation mode: NO, NC Type)</p>  <p>Pre-wired Connector Models (M1TJ)</p> <p>Vinyl-insulated round cable with 3 conductors M8, M12 size: 4-dia. M18, M30 size: 6-dia. (Conductor cross section: 0.2 mm² (AWG24), Insulator diameter: 1.05 mm), Standard length: 2 m (Operation mode: NO+NC Type)</p> <p>Vinyl-insulated round cable with 3 conductors M8, M12 size: 4-dia. M18, M30 size: 6-dia. (Conductor cross section: 0.2 mm² (AWG24), Insulator diameter: 1.05 mm), Standard length: 0.3 m</p> <p>Vinyl-insulated round cable with 4 conductors M12 size: 4.3-dia. M18, M30 size: 6-dia. (Conductor cross section: 0.2 mm² (AWG24), Insulator diameter: 1.05 mm), Standard length: 2 m</p> <p>Vinyl-insulated round cable with 4 conductors M12 size: 4.3-dia. M18, M30 size: 6-dia. (Conductor cross section: 0.2 mm² (AWG24), Insulator diameter: 1.05 mm), Standard length: 0.3 m</p>																																																																																																																																																																																																						
<p>M12 Pre-wired type (Shielded) E2A-M12KS04-WP-**/ E2A- S12KS04-WP-** E2A-M12LS04-WP-**/ E2A- S12LS04-WP-**</p>  <p>Note 1. 4-dia. vinyl-insulated round cable with 3 conductors (conductor cross section: 0.3 mm²; insulator diameter: 1.3 mm); standard length: 2 m 2. Operation indicator (yellow) 3. for NO+NC (-B3 / -C3) models the total length is 4 mm longer</p>  <p>Note 1. 4-dia. vinyl-insulated round cable with 3 conductors (conductor cross section: 0.3 mm²; insulator diameter: 1.3 mm); standard length: 2 m 2. Operation indicator (yellow)</p>	<p>Shielded</p> <table border="1"> <thead> <tr> <th>Model</th> <th>A</th> <th>B</th> <th>C</th> <th>D</th> <th>E</th> <th>F*1</th> <th>G*2</th> <th>H</th> <th>I</th> <th>J</th> </tr> </thead> <tbody> <tr> <td>E2E(Q)-X□8</td> <td>M8XP1</td> <td>37.8</td> <td>4.4</td> <td>26</td> <td>---</td> <td>10 (8)</td> <td>4</td> <td>3</td> <td>15</td> <td>13</td> </tr> <tr> <td>E2E(Q)-X□12</td> <td>M12XP1</td> <td>47.1</td> <td>3.7</td> <td>33</td> <td>---</td> <td>12 (10)</td> <td>4</td> <td>4</td> <td>21</td> <td>17</td> </tr> <tr> <td>E2E(Q)-X□18</td> <td>M18XP1</td> <td>55.3</td> <td>8.5</td> <td>38</td> <td>---</td> <td>12 (10)</td> <td>4</td> <td>4</td> <td>29</td> <td>24</td> </tr> <tr> <td>E2E(Q)-X□30</td> <td>M30XP1.5</td> <td>60.3</td> <td>8.3</td> <td>43</td> <td>---</td> <td>12 (10)</td> <td>4</td> <td>5</td> <td>42</td> <td>36</td> </tr> <tr> <td>E2E-X□L8</td> <td>M8XP1</td> <td>47.8</td> <td>4.4</td> <td>36</td> <td>---</td> <td>8</td> <td>---</td> <td>3</td> <td>15</td> <td>13</td> </tr> <tr> <td>E2E-X□L12</td> <td>M12XP1</td> <td>69.1</td> <td>3.7</td> <td>55</td> <td>---</td> <td>10</td> <td>---</td> <td>4</td> <td>21</td> <td>17</td> </tr> <tr> <td>E2E-X□L18</td> <td>M18XP1</td> <td>77.3</td> <td>8.5</td> <td>60</td> <td>---</td> <td>10</td> <td>---</td> <td>4</td> <td>29</td> <td>24</td> </tr> <tr> <td>E2E-X□L30</td> <td>M30XP1.5</td> <td>82.3</td> <td>8.3</td> <td>65</td> <td>---</td> <td>10</td> <td>---</td> <td>5</td> <td>42</td> <td>36</td> </tr> </tbody> </table> <p>Unshielded</p> <table border="1"> <thead> <tr> <th>Model</th> <th>A</th> <th>B</th> <th>C</th> <th>D</th> <th>E*3</th> <th>F</th> <th>G*2</th> <th>H</th> <th>I</th> <th>J</th> </tr> </thead> <tbody> <tr> <td>E2E-X□M□8</td> <td>M8XP1</td> <td>37.8</td> <td>4.4</td> <td>26</td> <td>6</td> <td>8</td> <td>---</td> <td>3</td> <td>15</td> <td>13</td> </tr> <tr> <td>E2E-X□M□12</td> <td>M12XP1</td> <td>47.1</td> <td>3.7</td> <td>33</td> <td>7</td> <td>10</td> <td>---</td> <td>4</td> <td>21</td> <td>17</td> </tr> <tr> <td>E2E-X□M□18</td> <td>M18XP1</td> <td>55.3</td> <td>8.5</td> <td>38</td> <td>10</td> <td>10</td> <td>---</td> <td>4</td> <td>29</td> <td>24</td> </tr> <tr> <td>E2E-X□M□30</td> <td>M30XP1.5</td> <td>60.3</td> <td>8.3</td> <td>43</td> <td>13</td> <td>10</td> <td>---</td> <td>5</td> <td>42</td> <td>36</td> </tr> <tr> <td>E2E-X□M□L8</td> <td>M8XP1</td> <td>47.8</td> <td>4.4</td> <td>36</td> <td>6</td> <td>8</td> <td>---</td> <td>3</td> <td>15</td> <td>13</td> </tr> <tr> <td>E2E-X□M□L12</td> <td>M12XP1</td> <td>69.1</td> <td>3.7</td> <td>55</td> <td>7</td> <td>10</td> <td>---</td> <td>4</td> <td>21</td> <td>17</td> </tr> <tr> <td>E2E-X□M□L18</td> <td>M18XP1</td> <td>77.3</td> <td>8.5</td> <td>60</td> <td>10</td> <td>10</td> <td>---</td> <td>4</td> <td>29</td> <td>24</td> </tr> <tr> <td>E2E-X□M□L30</td> <td>M30XP1.5</td> <td>82.3</td> <td>8.3</td> <td>65</td> <td>130 (15)</td> <td>10</td> <td>---</td> <td>5</td> <td>42</td> <td>36</td> </tr> </tbody> </table>	Model	A	B	C	D	E	F*1	G*2	H	I	J	E2E(Q)-X□8	M8XP1	37.8	4.4	26	---	10 (8)	4	3	15	13	E2E(Q)-X□12	M12XP1	47.1	3.7	33	---	12 (10)	4	4	21	17	E2E(Q)-X□18	M18XP1	55.3	8.5	38	---	12 (10)	4	4	29	24	E2E(Q)-X□30	M30XP1.5	60.3	8.3	43	---	12 (10)	4	5	42	36	E2E-X□L8	M8XP1	47.8	4.4	36	---	8	---	3	15	13	E2E-X□L12	M12XP1	69.1	3.7	55	---	10	---	4	21	17	E2E-X□L18	M18XP1	77.3	8.5	60	---	10	---	4	29	24	E2E-X□L30	M30XP1.5	82.3	8.3	65	---	10	---	5	42	36	Model	A	B	C	D	E*3	F	G*2	H	I	J	E2E-X□M□8	M8XP1	37.8	4.4	26	6	8	---	3	15	13	E2E-X□M□12	M12XP1	47.1	3.7	33	7	10	---	4	21	17	E2E-X□M□18	M18XP1	55.3	8.5	38	10	10	---	4	29	24	E2E-X□M□30	M30XP1.5	60.3	8.3	43	13	10	---	5	42	36	E2E-X□M□L8	M8XP1	47.8	4.4	36	6	8	---	3	15	13	E2E-X□M□L12	M12XP1	69.1	3.7	55	7	10	---	4	21	17	E2E-X□M□L18	M18XP1	77.3	8.5	60	10	10	---	4	29	24	E2E-X□M□L30	M30XP1.5	82.3	8.3	65	130 (15)	10	---	5	42	36
Model	A	B	C	D	E	F*1	G*2	H	I	J																																																																																																																																																																																													
E2E(Q)-X□8	M8XP1	37.8	4.4	26	---	10 (8)	4	3	15	13																																																																																																																																																																																													
E2E(Q)-X□12	M12XP1	47.1	3.7	33	---	12 (10)	4	4	21	17																																																																																																																																																																																													
E2E(Q)-X□18	M18XP1	55.3	8.5	38	---	12 (10)	4	4	29	24																																																																																																																																																																																													
E2E(Q)-X□30	M30XP1.5	60.3	8.3	43	---	12 (10)	4	5	42	36																																																																																																																																																																																													
E2E-X□L8	M8XP1	47.8	4.4	36	---	8	---	3	15	13																																																																																																																																																																																													
E2E-X□L12	M12XP1	69.1	3.7	55	---	10	---	4	21	17																																																																																																																																																																																													
E2E-X□L18	M18XP1	77.3	8.5	60	---	10	---	4	29	24																																																																																																																																																																																													
E2E-X□L30	M30XP1.5	82.3	8.3	65	---	10	---	5	42	36																																																																																																																																																																																													
Model	A	B	C	D	E*3	F	G*2	H	I	J																																																																																																																																																																																													
E2E-X□M□8	M8XP1	37.8	4.4	26	6	8	---	3	15	13																																																																																																																																																																																													
E2E-X□M□12	M12XP1	47.1	3.7	33	7	10	---	4	21	17																																																																																																																																																																																													
E2E-X□M□18	M18XP1	55.3	8.5	38	10	10	---	4	29	24																																																																																																																																																																																													
E2E-X□M□30	M30XP1.5	60.3	8.3	43	13	10	---	5	42	36																																																																																																																																																																																													
E2E-X□M□L8	M8XP1	47.8	4.4	36	6	8	---	3	15	13																																																																																																																																																																																													
E2E-X□M□L12	M12XP1	69.1	3.7	55	7	10	---	4	21	17																																																																																																																																																																																													
E2E-X□M□L18	M18XP1	77.3	8.5	60	10	10	---	4	29	24																																																																																																																																																																																													
E2E-X□M□L30	M30XP1.5	82.3	8.3	65	130 (15)	10	---	5	42	36																																																																																																																																																																																													
<p>M18 Pre-wired type (Shielded) E2A-M18KS08-WP-**/ E2A- S18KS08-WP-** E2A-M18LS08-WP-**/ E2A- S18LS08-WP-**</p>																																																																																																																																																																																																							

**Product discontinuation
Model E2A**

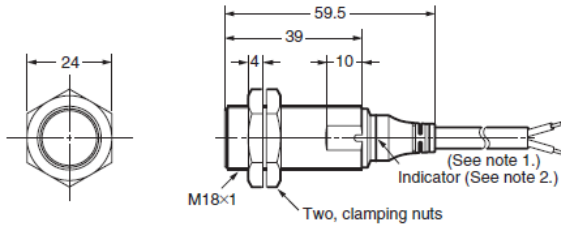

Note 1. 4-dia. vinyl-insulated round cable with 3 conductors (conductor cross section: 0.3 mm²; insulator diameter: 1.3 mm); standard length: 2 m
2. Operation indicator (yellow)

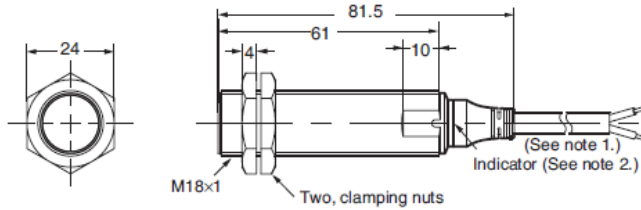

Note 1. 4-dia. vinyl-insulated round cable with 3 conductors (conductor cross section: 0.3 mm²; insulator diameter: 1.3 mm); standard length: 2 m
2. Operation indicator (yellow)

**M30 Pre-wired type (Shielded)
E2A-M30KS15-WP-*/ E2A- S30KS15-WP-**
E2A-M30LS15-WP-*/ E2A- S30LS15-WP-****

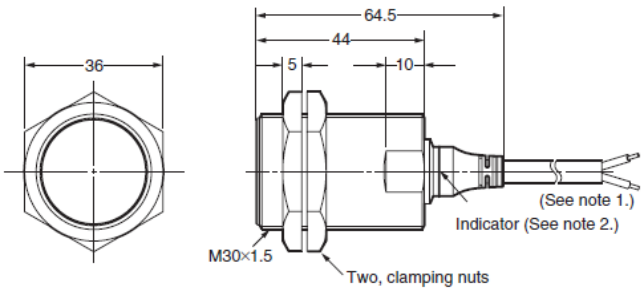

Note 1. 4-dia. vinyl-insulated round cable with 3 conductors (conductor cross section: 0.3 mm²; insulator diameter: 1.3 mm); standard length: 2 m
2. Operation indicator (yellow)

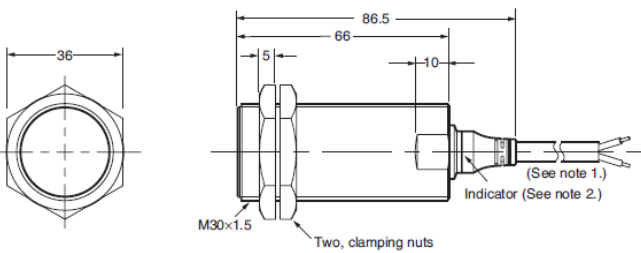

Note 1. 4-dia. vinyl-insulated round cable with 3 conductors (conductor cross section: 0.3 mm²; insulator diameter: 1.3 mm); standard length: 2 m
2. Operation indicator (yellow)

**Recommendable replacement
Model E2E-Next series**

Note1:E2E-Next series has one toothed washer.

Note2: E2E(Q) means E2EQ series and E2EQ series is for welding process type and has the threaded body and sensing head covered with the fluorine resin for spatter resistance.

Note.3:
Fixing Nut set is as same as E2A series.

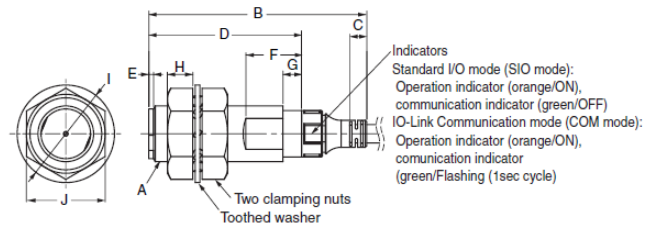

Pre-wired Models

(Operation mode: NO, NC Type)



Vinyl-insulated round cable with 3 conductors
M8, M12 size: 4-dia.
M18, M30 size: 6-dia.
(Conductor cross section: 0.2 mm² (AWG24),
Insulator diameter: 1.05 mm),
Standard length: 2 m

(Operation mode: NO+NC Type)



Vinyl-insulated round cable with 4 conductors
M12 size: 4.3-dia.
M18, M30 size: 6-dia.
(Conductor cross section: 0.2 mm² (AWG24),
Insulator diameter: 1.05 mm),
Standard length: 2 m

Pre-wired Connector Models (M1TJ)

M12xP1



(Operation mode: NO, NC Type)
Vinyl-insulated round cable with 3 conductors
M8, M12 size: 4-dia.
M18, M30 size: 6-dia.
(Conductor cross section: 0.2 mm² (AWG24),
Insulator diameter: 1.05 mm),
Standard length: 0.3 m

(Operation mode: NO+NC Type)
Vinyl-insulated round cable with 4 conductors
M12 size: 4.3-dia.
M18, M30 size: 6-dia.
(Conductor cross section: 0.2 mm² (AWG24),
Insulator diameter: 1.05 mm),
Standard length: 0.3 m

**Product discontinuation
Model E2A**

M8 Pre-wired type (Non-shielded)
E2A-S08KN04-WP-**/ E2A-S08LN04-WP-**

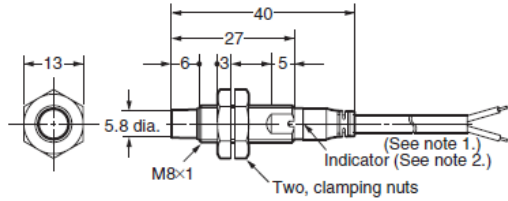

Note 1. 4-dia. vinyl-insulated round cable with 3 conductors (conductor cross section: 0.3 mm²; insulator diameter: 1.3 mm); standard length: 2 m
2. Operation indicator (yellow)

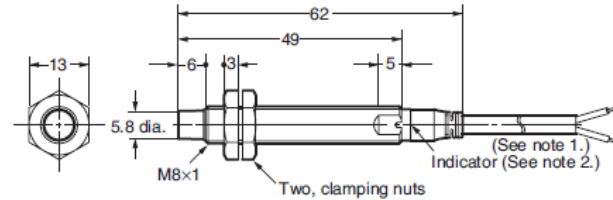

Note 1. 4-dia. vinyl-insulated round cable with 3 conductors (conductor cross section: 0.3 mm²; insulator diameter: 1.3 mm); standard length: 2 m
2. Operation indicator (yellow)

M12 Pre-wired type (Non-shielded)
E2A-M12KN08-WP-**/ E2A- S12KN08-WP-**
E2A-M12LN08-WP-**/ E2A- S12LN08-WP-**

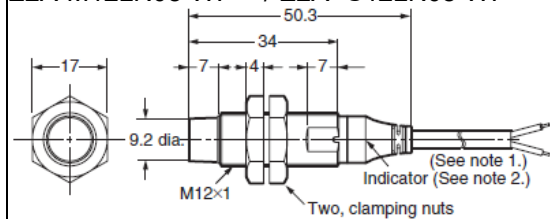

Note 1. 4-dia. vinyl-insulated round cable with 3 conductors (conductor cross section: 0.3 mm²; insulator diameter: 1.3 mm); standard length: 2 m
2. Operation indicator (yellow)
3. for NO+NC (-B3 / -C3) models the total length is 4 mm longer

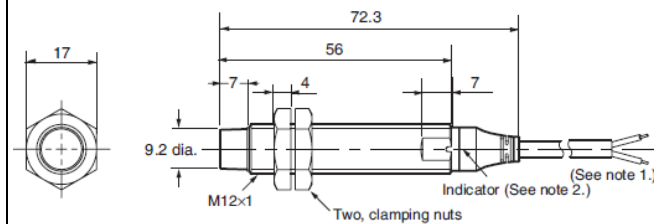

Note 1. 4-dia. vinyl-insulated round cable with 3 conductors (conductor cross section: 0.3 mm²; insulator diameter: 1.3 mm); standard length: 2 m
2. Operation indicator (yellow)

**Recommendable replacement
Model E2E-Next series**

Shielded

Model	A	B	C	D	E	F*1	G*2	H	I	J
E2E(Q)-X□8	M8XP1	37.8	4.4	26	---	10 (8)	4	3	15	13
E2E(Q)-X□12	M12XP1	47.1	3.7	33	---	12 (10)	4	4	21	17
E2E(Q)-X□18	M18XP1	55.3	8.5	38	---	12 (10)	4	4	29	24
E2E(Q)-X□30	M30XP1.5	60.3	8.3	43	---	12 (10)	4	5	42	36
E2E-X□L8	M8XP1	47.8	4.4	36	---	8	---	3	15	13
E2E-X□L12	M12XP1	69.1	3.7	55	---	10	---	4	21	17
E2E-X□L18	M18XP1	77.3	8.5	60	---	10	---	4	29	24
E2E-X□L30	M30XP1.5	82.3	8.3	65	---	10	---	5	42	36

Unshielded

Model	A	B	C	D	E*3	F	G*2	H	I	J
E2E-X□M□8	M8XP1	37.8	4.4	26	6	8	---	3	15	13
E2E-X□M□12	M12XP1	47.1	3.7	33	7	10	---	4	21	17
E2E-X□M□18	M18XP1	55.3	8.5	38	10	10	---	4	29	24
E2E-X□M□30	M30XP1.5	60.3	8.3	43	13	10	---	5	42	36
E2E-X□M□L8	M8XP1	47.8	4.4	36	6	8	---	3	15	13
E2E-X□M□L12	M12XP1	69.1	3.7	55	7	10	---	4	21	17
E2E-X□M□L18	M18XP1	77.3	8.5	60	10	10	---	4	29	24
E2E-X□M□L30	M30XP1.5	82.3	8.3	65	130 (15)	10	---	5	42	36

Note1:E2E-Next series has one toothed washer.

Note2: E2E(Q) means E2EQ series and E2EQ series is for welding process type and has the threaded body and sensing head covered with the fluorine resin for spatter resistance.

Note.3:
Fixing Nut set is as same as E2A series.

**Product discontinuation
Model E2A**

M18 Pre-wired type (Non-shielded)
E2A-M18KN16-WP-**/ E2A- S18KN16-WP-**
E2A-M18LN16-WP-**/ E2A- S18LN16-WP-**

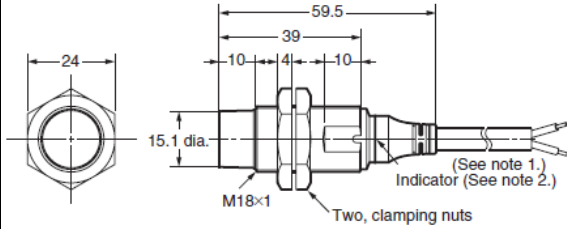

Note 1. 4-dia. vinyl-insulated round cable with 3 conductors (conductor cross section: 0.3 mm²; insulator diameter: 1.3 mm); standard length: 2 m
2. Operation indicator (yellow)

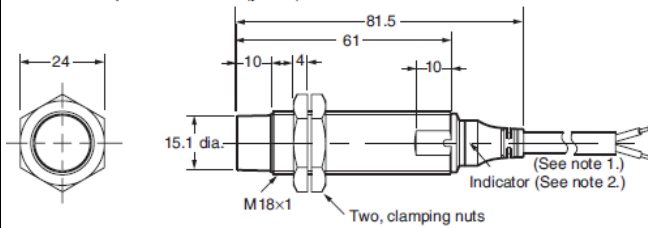

Note 1. 4-dia. vinyl-insulated round cable with 3 conductors (conductor cross section: 0.3 mm²; insulator diameter: 1.3 mm); standard length: 2 m
2. Operation indicator (yellow)

**Recommendable replacement
Model E2E-Next series**

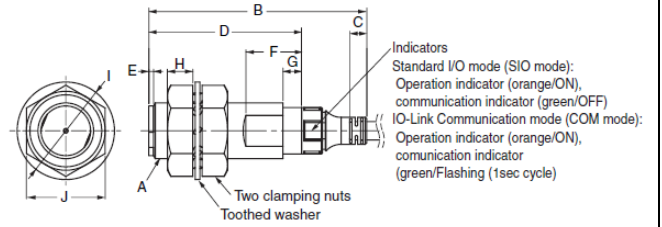

Pre-wired Models
(Operation mode: NO, NC Type)

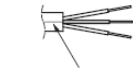

Vinyl-insulated round cable with 3 conductors
M8, M12 size: 4-dia.
M18, M30 size: 6-dia.
(Conductor cross section: 0.2 mm² (AWG24),
Insulator diameter: 1.05 mm),
Standard length: 2 m

(Operation mode: NO+NC Type)



Vinyl-insulated round cable with 4 conductors
M12 size: 4.3-dia.
M18/M30 size: 6-dia.
(Conductor cross section: 0.2 mm² (AWG24),
Insulator diameter: 1.05 mm),
Standard length: 2 m

Pre-wired Connector Models (M1TJ)
M12xP1



(Operation mode: NO, NC Type)
Vinyl-insulated round cable with 3 conductors
M8, M12 size: 4-dia.
M18, M30 size: 6-dia.
(Conductor cross section: 0.2 mm² (AWG24),
Insulator diameter: 1.05 mm),
Standard length: 0.3 m

(Operation mode: NO+NC Type)
Vinyl-insulated round cable with 4 conductors
M12 size: 4.3-dia.
M18, M30 size: 6-dia.
(Conductor cross section: 0.2 mm² (AWG24),
Insulator diameter: 1.05 mm),
Standard length: 0.3 m

**Product discontinuation
Model E2A**

M30 Pre-wired type (Non-shielded)
E2A-M30KN20-WP-**/ E2A- S30KN20-WP-**
E2A-M30LN30-WP-**/ E2A- S30LN30-WP-**

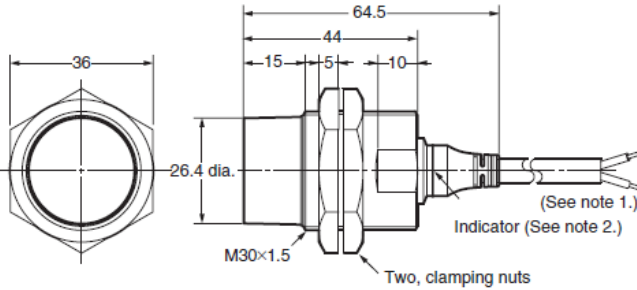

Note 1. 4-dia. vinyl-insulated round cable with 3 conductors (conductor cross section: 0.3 mm²; insulator diameter: 1.3 mm); standard length: 2 m
2. Operation indicator (yellow)

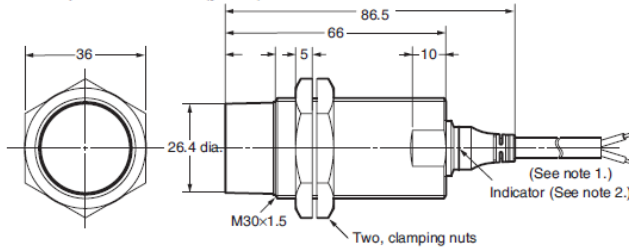

Note 1. 4-dia. vinyl-insulated round cable with 3 conductors (conductor cross section: 0.3 mm²; insulator diameter: 1.3 mm); standard length: 2 m
2. Operation indicator (yellow)

**Recommendable replacement
Model E2E-Next series**

Shielded

Model	A	B	C	D	E	F*1	G*2	H	I	J
E2E(Q)-X□8	M8XP1	37.8	4.4	26	---	10 (8)	4	3	15	13
E2E(Q)-X□12	M12XP1	47.1	3.7	33	---	12 (10)	4	4	21	17
E2E(Q)-X□18	M18XP1	55.3	8.5	38	---	12 (10)	4	4	29	24
E2E(Q)-X□30	M30XP1.5	60.3	8.3	43	---	12 (10)	4	5	42	36
E2E-X□L8	M8XP1	47.8	4.4	36	---	8	---	3	15	13
E2E-X□L12	M12XP1	69.1	3.7	55	---	10	---	4	21	17
E2E-X□L18	M18XP1	77.3	8.5	60	---	10	---	4	29	24
E2E-X□L30	M30XP1.5	82.3	8.3	65	---	10	---	5	42	36

Unshielded

Model	A	B	C	D	E*3	F	G*2	H	I	J
E2E-X□M□8	M8XP1	37.8	4.4	26	6	8	---	3	15	13
E2E-X□M□12	M12XP1	47.1	3.7	33	7	10	---	4	21	17
E2E-X□M□18	M18XP1	55.3	8.5	38	10	10	---	4	29	24
E2E-X□M□30	M30XP1.5	60.3	8.3	43	13	10	---	5	42	36
E2E-X□M□L8	M8XP1	47.8	4.4	36	6	8	---	3	15	13
E2E-X□M□L12	M12XP1	69.1	3.7	55	7	10	---	4	21	17
E2E-X□M□L18	M18XP1	77.3	8.5	60	10	10	---	4	29	24
E2E-X□M□L30	M30XP1.5	82.3	8.3	65	130 (15)	10	---	5	42	36

Note1: E2E-Next series has one toothed washer.

Note2: E2E(Q) means E2EQ series and E2EQ series is for welding process type and has the threaded body and sensing head covered with the fluorine resin for spatter resistance.

Note.3:
Fixing Nut set is as same as E2A series.

Please check the previous page.

M8 connector type with M12 size connector (Shielded)
E2A-S08KS02-M1-**/ E2A-S08LS02-M1-**

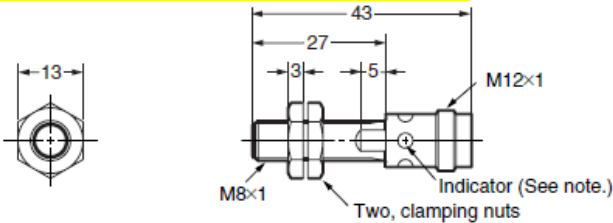

Note: Operation indicator (yellow LED, 4×90°)

The dimension table of connector models for E2E-Next series is on the next page

**Product discontinuation
Model E2A**

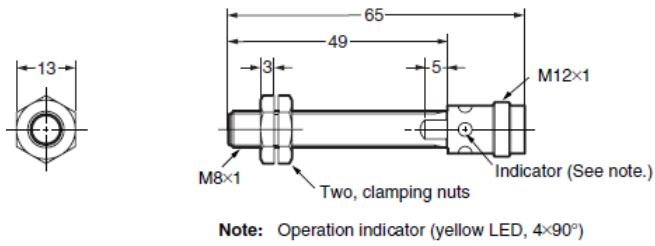

M12 connector type with M12 size connector
(Shielded)
E2A-M12KS04-M1-**/ E2A-S12KS04-M1-**
E2A-M12LS04-M1-**/ E2A-S12LS04-M1-**

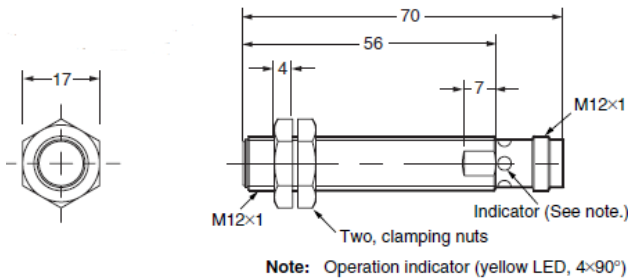
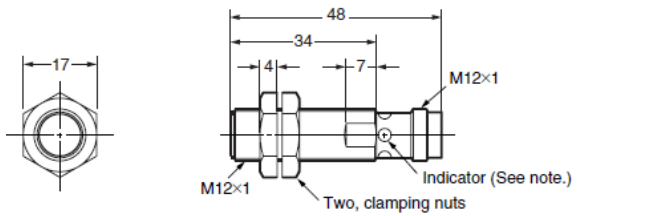

M18 connector type with M12 size connector
(Shielded)
E2A-M18KS08-M1-**/ E2A-S18KS08-M1-**
E2A-M18LS08-M1-**/ E2A-S18LS08-M1-**

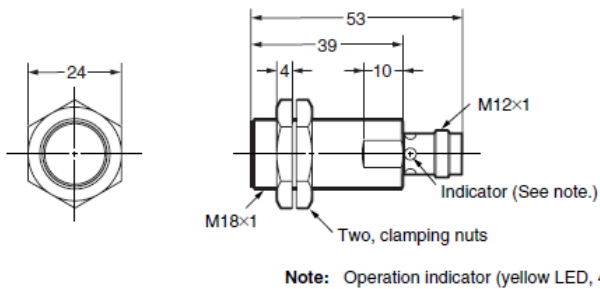

**Recommendable replacement
Model E2E-Next series**

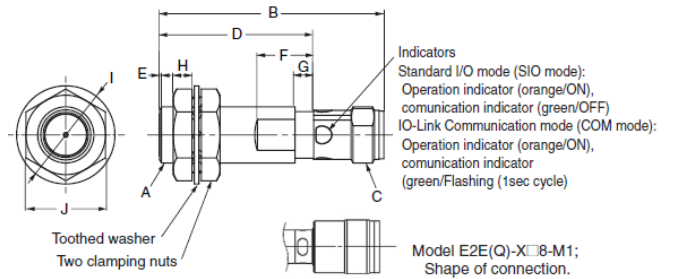

**Product discontinuation
Model E2A**

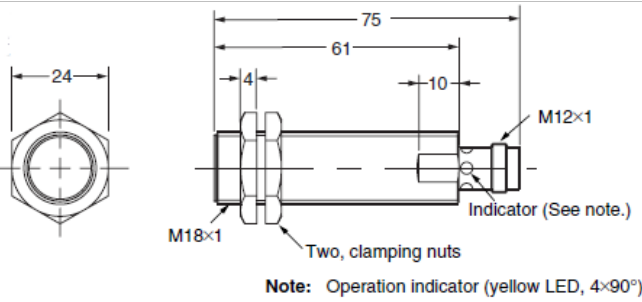

M30 connector type with M12 size connector
(Shielded)
E2A-M30KS15-M1-**/ E2A-S30KS15-M1-**
E2A-M30LS15-M1-**/E2A-S30LS15-M1-**

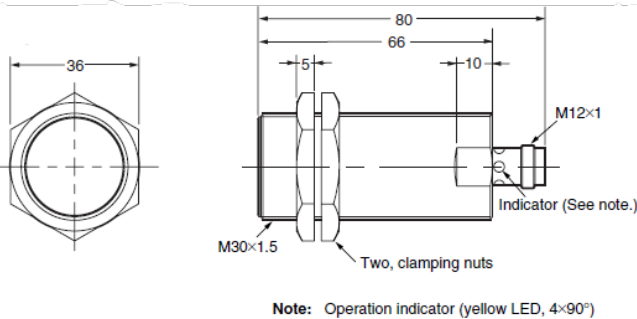
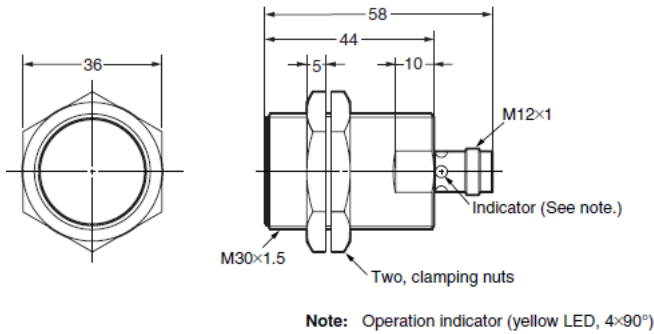

**Recommendable replacement
Model E2E-Next series**

Shielded

Model	A	B	C	D	E	F ^{*1}	G ^{*2}	H	I	J
E2E(Q)-X□30 X□8-M3/M5	M8XP1	39	M8XP1	26	---	10 (8)	4	3	15	13
E2E(Q)-X□8-M1	M8XP1	43	M12XP1	26	---	10 (8)	4	3	15	13
E2E(Q)-X□12-M1	M12XP1	48	M12XP1	33	---	12 (10)	4	4	21	17
E2E(Q)-X□18-M1	M18XP1	53	M12XP1	38	---	12 (10)	4	4	29	24
E2E(Q)-X□30-M1	M30XP1.5	58	M12XP1	43	---	12 (10)	4	5	42	36
E2E-X□L8-M3/M5	M8XP1	49	M8XP1	36	---	8	---	3	15	13
E2E-X□L8-M1	M8XP1	53	M12XP1	36	---	8	---	3	15	13
E2E-X□L12-M1	M12XP1	70	M12XP1	55	---	10	---	4	21	17
E2E-X□L18-M1	M18XP1	75	M12XP1	60	---	10	---	4	29	24
E2E-X□L30-M1	M30XP1.5	80	M12XP1	65	---	10	---	5	42	36

Unshielded

Model	A	B	C	D	E ^{*3}	F	G ^{*2}	H	I	J
E2E-X□M□8-M3/M5	M8XP1	39	M8XP1	26	6	8	---	3	15	13
E2E-X□M□8-M1	M8XP1	43	M12XP1	26	6	8	---	3	15	13
E2E-X□M□12-M1	M12XP1	48	M12XP1	26	7	10	---	4	21	17
E2E-X□M□18-M1	M18XP1	53	M12XP1	38	10	10	---	4	29	24
E2E-X□M□30-M1	M30XP1.5	58	M12XP1	43	13	10	---	5	42	36
E2E-X□M□L8-M3/M5	M8XP1	49	M8XP1	36	6	8	---	3	15	13
E2E-X□M□L8-M1	M8XP1	53	M12XP1	36	6	8	---	3	15	13
E2E-X□M□L12-M1	M12XP1	70	M12XP1	55	7	10	---	4	21	17
E2EX□M□L18-M1	M18XP1	75	M12XP1	60	10	10	---	4	29	24
E2E-X□M□L30-M1	M30XP1.5	80	M12XP1	65	13 (15)	10	---	5	42	36

Note.1: E2E-Next series has one toothed washer.

Note.2: E2E(Q) means E2EQ series and E2EQ series is for welding process type and has the threaded body and sensing head covered with the fluorine resin for spatter resistance.

Note.3:
Fixing Nut set is as same as E2A series.

**Product discontinuation
Model E2A**

M8 connector type with M12 size connector
(Non-shielded)

E2A-S08KN04-M1-*/ E2A-S08LN04-M1-*/

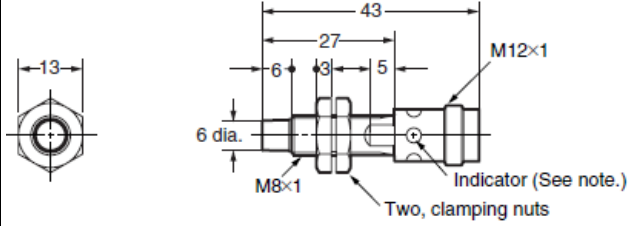

Note: Operation indicator (yellow LED, 4×90°)

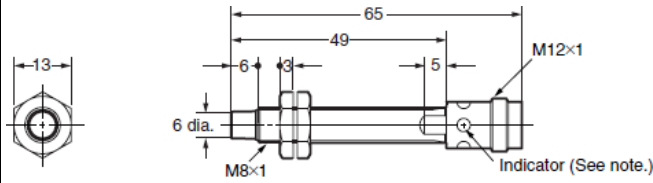

Note: Operation indicator (yellow LED, 4×90°)

**Recommendable replacement
Model E2E-Next series**

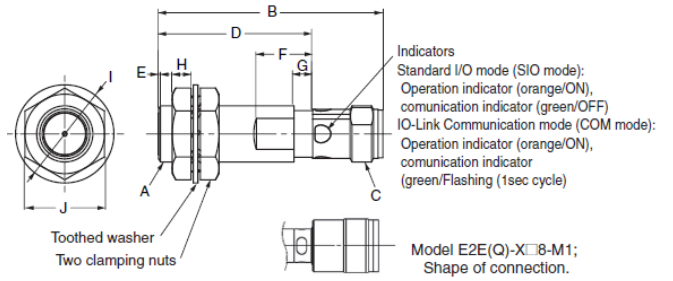

**Product discontinuation
Model E2A**

M12 connector type with M12 size connector
(Non-shielded)
E2A-M12KN08-M1-**/ E2A-S12KN08-M1-**
E2A-M12LN08-M1-**/ E2A-S12LN08-M1-**

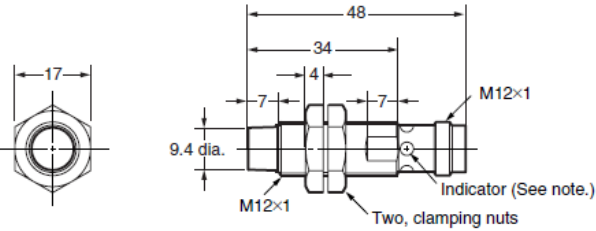

Note 1: Operation indicator (yellow LED, 4×90°)
Note 2: for NO+NC (-B3 / -C3) models the total length is 4 mm longer

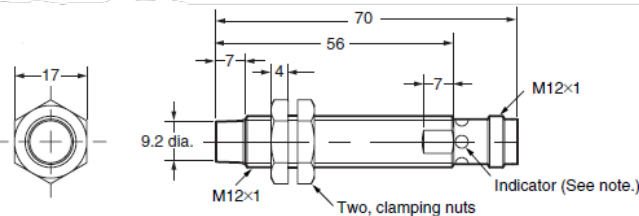

Note: Operation indicator (yellow LED, 4×90°)

**Recommendable replacement
Model E2E-Next series**

Shielded

Model	A	B	C	D	E	F ^{*1}	G ^{*2}	H	I	J
E2E(Q)-X□30 X□8-M3/M5	M8XP1	39	M8XP1	26	---	10 (8)	4	3	15	13
E2E(Q)-X□8-M1	M8XP1	43	M12XP1	26	---	10 (8)	4	3	15	13
E2E(Q)-X□12-M1	M12XP1	48	M12XP1	33	---	12 (10)	4	4	21	17
E2E(Q)-X□18-M1	M18XP1	53	M12XP1	38	---	12 (10)	4	4	29	24
E2E(Q)-X□30-M1	M30XP1.5	58	M12XP1	43	---	12 (10)	4	5	42	36
E2E-X□L8-M3/M5	M8XP1	49	M8XP1	36	---	8	---	3	15	13
E2E-X□L8-M1	M8XP1	53	M12XP1	36	---	8	---	3	15	13
E2E-X□L12-M1	M12XP1	70	M12XP1	55	---	10	---	4	21	17
E2E-X□L18-M1	M18XP1	75	M12XP1	60	---	10	---	4	29	24
E2E-X□L30-M1	M30XP1.5	80	M12XP1	65	---	10	---	5	42	36

Unshielded

Model	A	B	C	D	E	F	G	H	I	J
E2E-X□M□8-M3/M5	M8XP1	39	M8XP1	26	6	8	---	3	15	13
E2E-X□M□8-M1	M8XP1	43	M12XP1	26	6	8	---	3	15	13
E2E-X□M□12-M1	M12XP1	48	M12XP1	26	7	10	---	4	21	17
E2E-X□M□18-M1	M18XP1	53	M12XP1	38	10	10	---	4	29	24
E2E-X□M□30-M1	M30XP1.5	58	M12XP1	43	13	10	---	5	42	36
E2E-X□M□L8-M3-M5	M8XP1	49	M8XP1	36	6	8	---	3	15	13
E2E-X□M□L8-M1	M8XP1	53	M12XP1	36	6	8	---	3	15	13
E2E-X□M□L12-M1	M12XP1	70	M12XP1	55	7	10	---	4	21	17
E2EX□M□L18-M1	M18XP1	75	M12XP1	60	10	10	---	4	29	24
E2E-X□M□L30-M1	M30XP1.5	80	M12XP1	65	13 ¹³⁰ (15)	10	---	5	42	36

Note.1: E2E-Next series has one toothed washer.

Note.2: E2E(Q) means E2EQ series and E2EQ series is for welding process type and has the threaded body and sensing head covered with the fluorine resin for spatter resistance.

Note.3:
Fixing Nut set is as same as E2A series.

**Product discontinuation
Model E2A**

M18 connector type with M12 size connector
(Non-shielded)
E2A-M18KN16-M1-**/ E2A-S18KN16-M1-**
E2A-M18LN16-M1-**/ E2A-S18LN16-M1-**

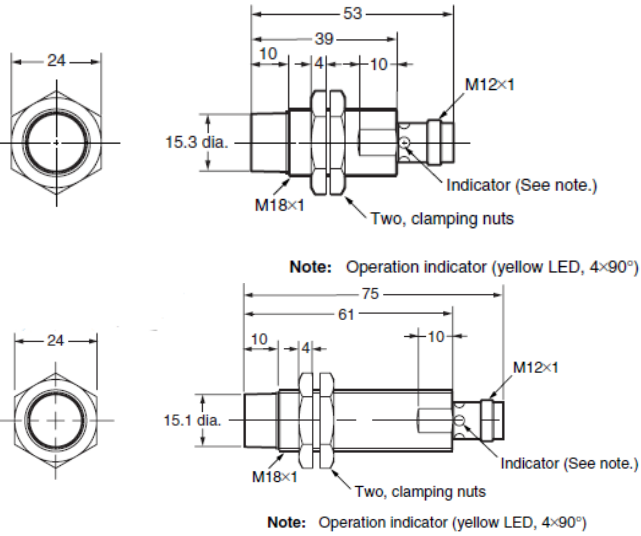

**Recommendable replacement
Model E2E-Next series**

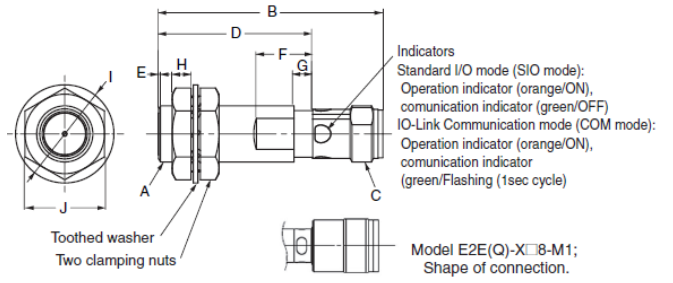

**Product discontinuation
Model E2A**

M30 connector type with M12 size connector
(Non-shielded)
E2A-M30KN20-M1-**/ E2A-S30KN20-M1-**
E2A-M30LN30-M1-**/ E2A-S30LN30-M1-**

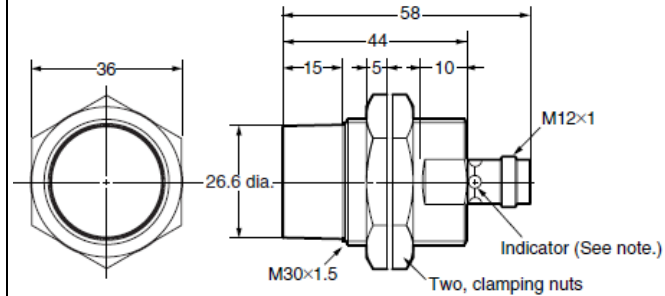

Note: Operation indicator (yellow LED, 4×90°)

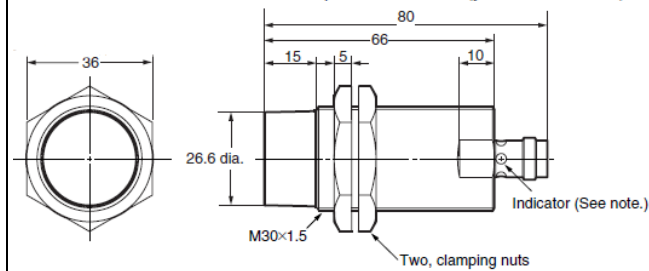

Note: Operation indicator (yellow LED, 4×90°)

**Recommendable replacement
Model E2E-Next series**

Shielded

Model	A	B	C	D	E	F ^{*1}	G ^{*2}	H	I	J
E2E(Q)-X□30 X□8-M3/M5	M8XP1	39	M8XP1	26	---	10 (8)	4	3	15	13
E2E(Q)-X□8-M1	M8XP1	43	M12XP1	26	---	10 (8)	4	3	15	13
E2E(Q)-X□12-M1	M12XP1	48	M12XP1	33	---	12 (10)	4	4	21	17
E2E(Q)-X□18-M1	M18XP1	53	M12XP1	38	---	12 (10)	4	4	29	24
E2E(Q)-X□30-M1	M30XP1.5	58	M12XP1	43	---	12 (10)	4	5	42	36
E2E-X□L8-M3/M5	M8XP1	49	M8XP1	36	---	8	---	3	15	13
E2E-X□L8-M1	M8XP1	53	M12XP1	36	---	8	---	3	15	13
E2E-X□L12-M1	M12XP1	70	M12XP1	55	---	10	---	4	21	17
E2E-X□L18-M1	M18XP1	75	M12XP1	60	---	10	---	4	29	24
E2E-X□L30-M1	M30XP1.5	80	M12XP1	65	---	10	---	5	42	36

Unshielded

Model	A	B	C	D	E	F	G	H	I	J
E2E-X□M□8-M3/M5	M8XP1	39	M8XP1	26	6	8	---	3	15	13
E2E-X□M□8-M1	M8XP1	43	M12XP1	26	6	8	---	3	15	13
E2E-X□M□12-M1	M12XP1	48	M12XP1	26	7	10	---	4	21	17
E2E-X□M□18-M1	M18XP1	53	M12XP1	38	10	10	---	4	29	24
E2E-X□M□30-M1	M30XP1.5	58	M12XP1	43	13	10	---	5	42	36
E2E-X□M□L8-M3/M5	M8XP1	49	M8XP1	36	6	8	---	3	15	13
E2E-X□M□L8-M1	M8XP1	53	M12XP1	36	6	8	---	3	15	13
E2E-X□M□L12-M1	M12XP1	70	M12XP1	55	7	10	---	4	21	17
E2EX□M□L18-M1	M18XP1	75	M12XP1	60	10	10	---	4	29	24
E2E-X□M□L30-M1	M30XP1.5	80	M12XP1	65	13 ³ (15)	10	---	5	42	36

Note.1: E2E-Next series has one toothed washer.

Note.2: E2E(Q) means E2EQ series and E2EQ series is for welding process type and has the threaded body and sensing head covered with the fluorine resin for spatter resistance.

Note.3:
Fixing Nut set is as same as E2A series.

**Product discontinuation
Model E2A**

M8 connector type with M8 size connector (Shielded)
E2A-S08KS02-M5-*/ E2A-S08KS02-M3-*/
E2A-S08LS02-M5-*/ E2A-S08LS02-M3-*/

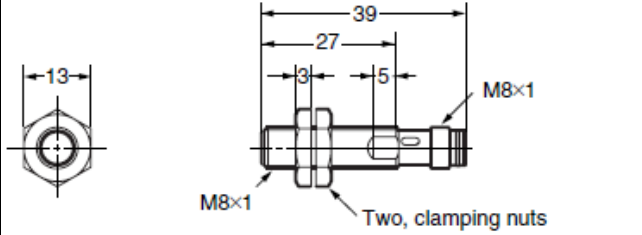

Note: Operation indicator (yellow LED, 4x90°)

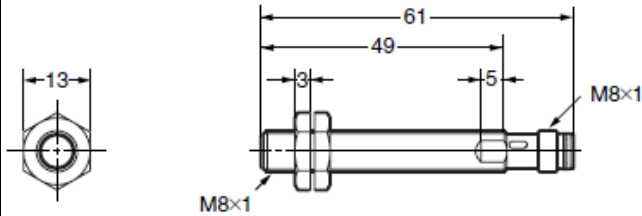

Note: Operation indicator (yellow LED, 4x90°)

**Recommendable replacement
Model E2E-Next series**

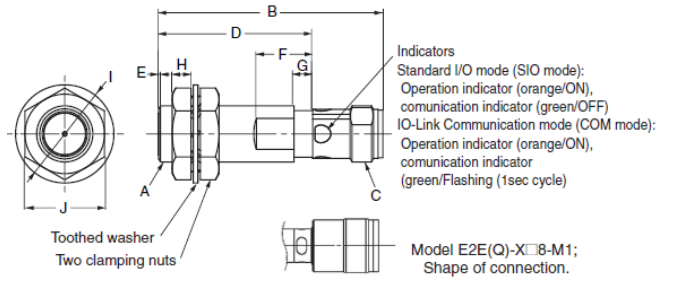

**Product discontinuation
Model E2A**

M8 connector type with M8 size connector
(Non-shielded)

E2A-S08KN04-M5-*/ E2A-S08KN04-M3-*/
E2A-S08LN04-M5-*/ E2A-S08LN04-M3-*/

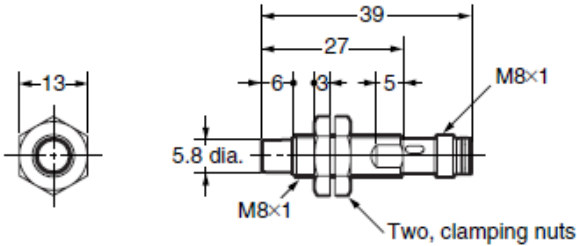

Note: Operation indicator (yellow LED, 4×90°)

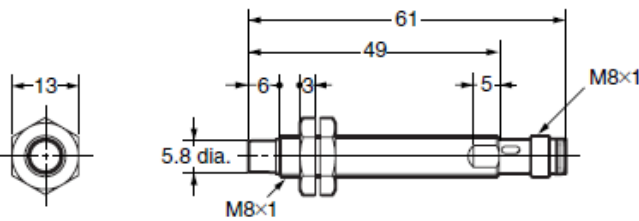

Note: Operation indicator (yellow LED, 4×90°)

**Recommendable replacement
Model E2E-Next series**

Shielded

Model	A	B	C	D	E	F ^{*1}	G ^{*2}	H	I	J
E2E(Q)-X□30 X□8-M3/M5	M8XP1	39	M8XP1	26	---	10 (8)	4	3	15	13
E2E(Q)-X□8-M1	M8XP1	43	M12XP1	26	---	10 (8)	4	3	15	13
E2E(Q)-X□12-M1	M12XP1	48	M12XP1	33	---	12 (10)	4	4	21	17
E2E(Q)-X□18-M1	M18XP1	53	M12XP1	38	---	12 (10)	4	4	29	24
E2E(Q)-X□30-M1	M30XP1.5	58	M12XP1	43	---	12 (10)	4	5	42	36
E2E-X□L8-M3/M5	M8XP1	49	M8XP1	36	---	8	---	3	15	13
E2E-X□L8-M1	M8XP1	53	M12XP1	36	---	8	---	3	15	13
E2E-X□L12-M1	M12XP1	70	M12XP1	55	---	10	---	4	21	17
E2E-X□L18-M1	M18XP1	75	M12XP1	60	---	10	---	4	29	24
E2E-X□L30-M1	M30XP1.5	80	M12XP1	65	---	10	---	5	42	36

Unshielded

Model	A	B	C	D	E	F	G	H	I	J
E2E-X□M□8-M3/M5	M8XP1	39	M8XP1	26	6	8	---	3	15	13
E2E-X□M□8-M1	M8XP1	43	M12XP1	26	6	8	---	3	15	13
E2E-X□M□12-M1	M12XP1	48	M12XP1	26	7	10	---	4	21	17
E2E-X□M□18-M1	M18XP1	53	M12XP1	38	10	10	---	4	29	24
E2E-X□M□30-M1	M30XP1.5	58	M12XP1	43	13	10	---	5	42	36
E2E-X□M□L8-M3-M5	M8XP1	49	M8XP1	36	6	8	---	3	15	13
E2E-X□M□L8-M1	M8XP1	53	M12XP1	36	6	8	---	3	15	13
E2E-X□M□L12-M1	M12XP1	70	M12XP1	55	7	10	---	4	21	17
E2EX□M□L18-M1	M18XP1	75	M12XP1	60	10	10	---	4	29	24
E2E-X□M□L30-M1	M30XP1.5	80	M12XP1	65	13 ¹³⁰ (15)	10	---	5	42	36

Note.1: E2E-Next series has one toothed washer.

Note.2: E2E(Q) means E2EQ series and E2EQ series is for welding process type and has the threaded body and sensing head covered with the fluorine resin for spatter resistance.

Note.3:
Fixing Nut set is as same as E2A series.

[The difference of characteristics and operation ratings.]

Item	Product discontinuation Model E2A series	Recommendable replacement Model E2E-Next series
Differential travel	10% max of sensing distance	15% max of sensing distance
Power supply voltage	12 to 24 VDC. Ripple(p-p): 10% max.	10 to 30 VDC (including 10% ripple (p-p)), Class 2
Load current (M8)	200 mA max. (32 VDC max.) When using any model at an ambient temperature between -40°C and -25°C and a power voltage between 30 and 32 VDC, use a load current of 100 mA max.,	1-output models: 10 to 30 VDC, Class 2, 200 mA max., (-40 to 70°C), 100 mA max., (70 to 85°C) 2-output models: 10 to 30 VDC, Class 2, 50 mA max.
Load current (Other than M8 size)		1-output models: 10 to 30 VDC, Class 2, 200 mA max., 2-output models: 10 to 30 VDC, Class 2, 100 mA max.
Current consumption	10mA max.	1-output models: 16 mA max. 2-output models: 20 mA max.
Ambient air temperature	Operating: -40°C to 70°C, Storage: -40 to 85 (with no icing or condensation)	Operating/Storage: -40 to 85°C (with no icing or condensation) Note: The UL temperature rating for M12 Pre-wired Connector Models is -25 to 70°C.
Temperature influence	±10% max. of sensing distance at 23°C within temperature range of -25°C to 70°C ±15% max. of sensing distance at 23°C within temperature range of -40°C to 70°C	±10% max. of sensing distance at 23°C in the temperature range of -25 to 70°C ±15% max. of sensing distance at 23°C in the temperature range of -40 to 85°C

■The models that will not be discontinued.

Because of no alternative products ,as following E2A series will not discontinued in 2022 March.

Table.2

Product Code	Model name	Comments for continue
E2A 1095R	E2A-M18KS08-M1-B2-20	Multipack
E2A 7073M	E2A-M30KN20-WP-C2 2M	
E2A 7074R	E2A-M30KN20-WP-C1 2M	
E2A 7075G	E2A-M30KN20-WP-B2 2M	
E2A 7076E	E2A-M30KN20-WP-B1 2M	
E2A 7077C	E2A-M30KN20-WP-C2 5M	
E2A 7078A	E2A-M30KN20-WP-C1 5M	
E2A 7079M	E2A-M30KN20-WP-B2 5M	
E2A 7080C	E2A-M30KN20-WP-B1 5M	
E2A 7081A	E2A-M30KN20-M1-C2	
E2A 7082M	E2A-M30KN20-M1-C1	
E2A 7083H	E2A-M30KN20-M1-B2	
E2A 7084F	E2A-M30KN20-M1-B1	
E2A 7145A	E2A-M18KS08-WP-C1 10M	
E2A 7146M	E2A-M18KS08-WP-C1-1 5M	
E2A 7147H	E2A-M12KS04-WP-B1 6M	
E2A 7148F	E2A-M12KS04-WP-B2 8M	
E2A 7149D	E2A-M18KS08-WP-B1 10M	
E2A 7150H	E2A-M12KN08-WP-B1 10M	
E2A 7151F	E2A-M18LS08-WP-B1-2 3.55M	Customized
E2A 7152D	E2A-M18KS08-WP-B1 3.5M	
E2A 7153B	E2A-M30LN30-WP-B2 10M	
E2A 7154M	E2A-S18KS08-M1-B1	Stainless body
E2A 7155R	E2A-S18KN16-M1-B1	Stainless body
E2A 7156G	E2A-S30KS15-M1-B1	Stainless body
E2A 7157E	E2A-S30KN20-M1-B1	Stainless body
E2A 7158C	E2A-M18KS08-WS-B1 0.5M	Stainless body
E2A 7159A	E2A-M12LS04-WP-B1 7M	Stainless body

Product Code	Model name	Comments for continue
E2A 7160E	E2A-M12KS04-WP-B1 12M	Stainless body
E2A 7161C	E2A-M12KS04-WP-B1 10M	Stainless body
E2A 7162A	E2A-M30KS15-WP-B1 10M	Stainless body
E2A 7163M	E2A-M30KS15-WP-C1 10M	Stainless body
E2A 7164H	E2A-M12KS04-WP-C1 10M	Stainless body
E2A 7165F	E2A-M18KS08-WS-B1-3 2M	Stainless body
E2A 7166D	E2A-M12KS04-WP-D1 2M	Stainless body
E2A 7167B	E2A-M12KN08-WP-D1 2M	Stainless body
E2A 7168M	E2A-M18KS08-WP-D1 2M	Stainless body
E2A 7169R	E2A-M18KN16-WP-D1 2M	Stainless body
E2A 7170B	E2A-M30KS15-WP-D1 2M	Stainless body
E2A 7171M	E2A-M30KN20-WP-D1 2M	Stainless body
E2A 7172R	E2A-M12KS04-WP-D2 2M	Stainless body
E2A 7173G	E2A-M12KN08-WP-D2 2M	Stainless body
E2A 7174E	E2A-M18KS08-WP-D2 2M	Stainless body
E2A 7175C	E2A-M18KN16-WP-D2 2M	Stainless body
E2A 7176A	E2A-M30KS15-WP-D2 2M	Stainless body
E2A 7177M	E2A-M30KN20-WP-D2 2M	Stainless body
E2A 7178H	E2A-M12LS04-WP-D1 2M	Stainless body
E2A 7179F	E2A-M12LN08-WP-D1 2M	Stainless body
E2A 7180M	E2A-M18LS08-WP-D1 2M	Stainless body
E2A 7181H	E2A-M18LN16-WP-D1 2M	Stainless body
E2A 7182F	E2A-M30LS15-WP-D1 2M	Stainless body
E2A 7183D	E2A-M30LN30-WP-D1 2M	Stainless body
E2A 7184B	E2A-M12LS04-WP-D2 2M	Stainless body
E2A 7185M	E2A-M12LN08-WP-D2 2M	Stainless body
E2A 7186R	E2A-M18LS08-WP-D2 2M	Stainless body
E2A 7187G	E2A-M18LN16-WP-D2 2M	Stainless body
E2A 7188E	E2A-M30LS15-WP-D2 2M	Stainless body
E2A 7189C	E2A-M30LN30-WP-D2 2M	Stainless body
E2A 7190G	E2A-M12KS04-WP-D1 5M	Stainless body

Product Code	Model name	Comments for continue
E2A 7191E	E2A-M18KS08-WP-D1 5M	Stainless body
E2A 7196F	E2A-S08KN04-M1-C1	Stainless body
E2A 7197D	E2A-S08KN04-M5-B1	Stainless body
E2A 7198B	E2A-S08KN04-WP-B1 2M	Stainless body
E2A 7199M	E2A-S08KS02-M1-B1	Stainless body
E2A 7200H	E2A-S08KS02-M5-C1	Stainless body
E2A 7201F	E2A-S08KS02-WP-C1 2M	Stainless body
E2A 7202D	E2A-S08LN04-M1-B1	Stainless body
E2A 7203B	E2A-S08LN04-M5-C1	Stainless body
E2A 7204M	E2A-S08LN04-WP-C1 2M	Stainless body
E2A 7205R	E2A-S08LS02-M1-C1	Stainless body
E2A 7206G	E2A-S08LS02-M5-B1	Stainless body
E2A 7207E	E2A-S08LS02-WP-B1 2M	Stainless body
E2A 7220B	E2A-S08KN04-M1-B1	Stainless body
E2A 7221M	E2A-S08KN04-M1-B2	Stainless body
E2A 7222R	E2A-S08KN04-M1-C2	Stainless body
E2A 7223G	E2A-S08KN04-M5-B2	Stainless body
E2A 7224E	E2A-S08KN04-M5-C1	Stainless body
E2A 7225C	E2A-S08KN04-M5-C2	Stainless body
E2A 7226A	E2A-S08KN04-WP-B1 5M	Stainless body
E2A 7227M	E2A-S08KN04-WP-B2 2M	Stainless body
E2A 7228H	E2A-S08KN04-WP-B2 5M	Stainless body
E2A 7229F	E2A-S08KN04-WP-C1 2M	Stainless body
E2A 7230M	E2A-S08KN04-WP-C1 5M	Stainless body
E2A 7231H	E2A-S08KN04-WP-C2 2M	Stainless body
E2A 7232F	E2A-S08KN04-WP-C2 5M	Stainless body
E2A 7233D	E2A-S08KS02-M1-B2	Stainless body
E2A 7234B	E2A-S08KS02-M1-C1	Stainless body
E2A 7235M	E2A-S08KS02-M1-C2	Stainless body
E2A 7236R	E2A-S08KS02-M5-B1	Stainless body
E2A 7237G	E2A-S08KS02-M5-B2	Stainless body

Product Code	Model name	Comments for continue
E2A 7238E	E2A-S08KS02-M5-C2	Stainless body
E2A 7239C	E2A-S08KS02-WP-B1 2M	Stainless body
E2A 7240G	E2A-S08KS02-WP-B1 5M	Stainless body
E2A 7241E	E2A-S08KS02-WP-B2 2M	Stainless body
E2A 7242C	E2A-S08KS02-WP-B2 5M	Stainless body
E2A 7243A	E2A-S08KS02-WP-C1 5M	Stainless body
E2A 7244M	E2A-S08KS02-WP-C2 2M	Stainless body
E2A 7245H	E2A-S08KS02-WP-C2 5M	Stainless body
E2A 7246F	E2A-S08LN04-M1-B2	Stainless body
E2A 7247D	E2A-S08LN04-M1-C1	Stainless body
E2A 7248B	E2A-S08LN04-M1-C2	Stainless body
E2A 7249M	E2A-S08LN04-M5-B1	Stainless body
E2A 7250D	E2A-S08LN04-M5-B2	Stainless body
E2A 7251B	E2A-S08LN04-M5-C2	Stainless body
E2A 7252M	E2A-S08LN04-WP-B1 2M	Stainless body
E2A 7253R	E2A-S08LN04-WP-B1 5M	Stainless body
E2A 7254G	E2A-S08LN04-WP-B2 2M	Stainless body
E2A 7255E	E2A-S08LN04-WP-B2 5M	Stainless body
E2A 7256C	E2A-S08LN04-WP-C1 5M	Stainless body
E2A 7257A	E2A-S08LN04-WP-C2 2M	Stainless body
E2A 7258M	E2A-S08LN04-WP-C2 5M	Stainless body
E2A 7259H	E2A-S08LS02-M1-B1	Stainless body
E2A 7260A	E2A-S08LS02-M1-B2	Stainless body
E2A 7261M	E2A-S08LS02-M1-C2	Stainless body
E2A 7262H	E2A-S08LS02-M5-B2	Stainless body
E2A 7263F	E2A-S08LS02-M5-C1	Stainless body
E2A 7264D	E2A-S08LS02-M5-C2	Stainless body
E2A 7265B	E2A-S08LS02-WP-B1 5M	Stainless body
E2A 7266M	E2A-S08LS02-WP-B2 2M	Stainless body
E2A 7267R	E2A-S08LS02-WP-B2 5M	Stainless body
E2A 7268G	E2A-S08LS02-WP-C1 2M	Stainless body

Product Code	Model name	Comments for continue
E2A 7269E	E2A-S08LS02-WP-C1 5M	Stainless body
E2A 7270R	E2A-S08LS02-WP-C2 2M	Stainless body
E2A 7271G	E2A-S08LS02-WP-C2 5M	Stainless body
E2A 7272E	E2A-S08KS02-WP-C1 3M	Stainless body
E2A 7273C	E2A-M12KS04-WP-D1-1 5M	Stainless body
E2A 7274A	E2A-M18KS08-WP-D1-1 5M	Stainless body
E2A 7277F	E2A-S08KS01-WP-B1 5M	Stainless body
E2A 7278D	E2A-M18KS08-M1-B1-GP50	Stainless body
E2A 7279B	E2A-M12KN08-WP-B1 7M	Stainless body
E2A 7280F	E2A-M12KN05-WP-B1-TP 5M	Stainless body
E2A 7281D	E2A-M12LN05-WP-B1-TP 5M	Stainless body
E2A 7282B	E2A-S08KS01-WP-B1-TP 5M	Stainless body
E2A 7283M	E2A-M18KS08-WS-B3-G1S 2.6M	Stainless body
E2A 7284R	E2A-M18KS08-WS-B3-G3S 1.5M	Stainless body
E2A 7292M	E2A-M18KS05-WP-B1 6M	Stainless body
E2A 7293H	E2A-S08KN04-WP-C1 10M	Stainless body
E2A 7294F	E2A-M12KN08-WP-B1 12M	Stainless body
E2A 7295D	E2A-S08KS02-WP-B1 3M	Stainless body
E2A 7296B	E2A-M12KN05-M1-B1-TP	Stainless body
E2A 7298R	E2A-M12KS02-WP-B1-TP 5M	Stainless body
E2A 7301B	E2A-M18KN10-WP-B1 10M	Stainless body
E2A 7302M	E2A-M18KN10-WP-B1-TP 5M	Stainless body
E2A 7303R	E2A-M18KS05-WP-B1-TP 6M	Stainless body
E2A 7304G	E2A-M18LS08-WP-B1 8M	Stainless body
E2A 7305E	E2A-M30KS15-WP-B2 10M	Stainless body
E2A 7306C	E2A-M30LS15-WP-B1 6M	Stainless body
E2A 7307A	E2A-S08KS01-M3-B1	Stainless body
E2A 7308M	E2A-S08KS01-M3-B1-TP	Stainless body
E2A 7309H	E2A-M12KS04-WP-C1-BM 5M	Stainless body
E2A 7310A	E2A-M18KS08-WS-B1-G1S 2.6M	Stainless body
E2A 7311M	E2A-M18KS08-WS-B2-A 2M	Stainless body

Product Code	Model name	Comments for continue
E2A 7312H	E2A-M18KS08-WS-B1-A 2M	Stainless body
E2A 7313F	E2A-M18KS08-WS-B2-A 5M	Stainless body
E2A 7314D	E2A-979944	Stainless body
E2A 7315B	E2A-979946	Stainless body
E2A 7316M	E2A-979947	Stainless body
E2A 7317R	E2A-08.02368	Stainless body
E2A 7318G	E2A-S12KN08-WP-B1 2M	Stainless body
E2A 7319E	E2A-M18LS08-WP-B3 15M	Stainless body
E2A 7322E	E2A-S08KS02-M3-B1	Stainless body
E2A 7323C	E2A-S08KS02-WP-B1 10M	Stainless body
E2A 7324A	E2A-S08KS02-WP-B1-1 0.05M	Stainless body
E2A 7325M	E2A-S12KN05-M1-B1	Stainless body
E2A 7329B	E2A-M12KS04-WS-C1-A 2M	Stainless body
E2A 7331D	E2A-979974	Stainless body
E2A 7332B	E2A-979976	Stainless body
E2A 7333M	E2A-979978	Stainless body
E2A 7335G	E2A-M12LS02-WP-B1-TP 5M	Stainless body
E2A 7338A	E2A-S08KS01-M1-B1	Stainless body
E2A 7339M	E2A-S08KS02-M3-B2	Stainless body
E2A 7340C	E2A-S08LS02-M3-B1	Stainless body
E2A 7347M	E2A-S08KS02-WP-C2-ASS 3M	Stainless body
E2A 7348R	E2A-M18KS05-M1-B3-Z1	Stainless body
E2A 7349G	E2A-S08LS02-WP-D1 2M	Stainless body
E2A 7350M	E2A-M18KS08-WS-B3-G2S 0.5M	Stainless body
E2A 7351R	E2A-M18KS08-M1-B1-S	Stainless body
E2A 7352G	E2A-S30KS15-WP-B1-LW 5M	Stainless body
E2A 7353E	E2A-S30KS15-WP-C1-LW 5M	Stainless body
E2A 7354C	E2A-7621800	Stainless body
E2A 7355A	E2A-M12LS04-M1-B1-FE	Stainless body
E2A 7356M	E2A-S08KS01-WP-B1 6M	Stainless body
E2A 7357H	E2A-M12KS04-WP-B1 1M	Stainless body

Product Code	Model name	Comments for continue
E2A 7358F	E2A-M12KN08-WP-HI25 1M	Stainless body
E2A 7359D	E2A-M18KN16-WP-B1 10M	Stainless body
E2A 7360H	E2A-M12KS04-WP-B2 3M	Stainless body
E2A 7361F	E2A-M12KS04-WP-B2 6M	Stainless body
E2A 7362D	E2A-M18LN16-WP-B2-2 2M	Stainless body
E2A 7363B	E2A-S08LS02-WP-B2 10M	Stainless body
E2A 7364M	E2A-S08KS02-WP-B2 10M	Stainless body
E2A 7365R	E2A-S18KS08-WS-B1 5M	Stainless body
E2A 7366G	E2A-S12KN08-WP-C1 2M	Stainless body
E2A 7367E	E2A-S12KS04-WP-B1 2M	Stainless body
E2A 7368C	E2A-S12KS04-M1-B1	Stainless body
E2A 7369A	E2A-M30KS15-WP-D1 3M	Stainless body
E2A 7370E	E2A-M18LS08-WS-B1-M01	Stainless body
E2A 7371C	E2A-M18LS08-WP-B1 6M	Stainless body
E2A 7372A	E2A-08.02368.1	Stainless body
E2A 7373M	E2A-M18KS08-WP-B2 1M	Stainless body
E2A 7374H	E2A-M30KS15-WP-B1 1M	Stainless body
E2A 7375F	E2A-M30KS15-WP-B2-1 1M	Stainless body
E2A 7376D	E2A-Z4300010	Stainless body
E2A 7377B	E2A-M18LS08-WP-B1-1 3.55M	Stainless body
E2A 7378M	E2A-M18LS08-WP-B1-1 6M	Stainless body
E2A 7379R	E2A-M18LS08-M1-D1	Stainless body
E2A 7380B	E2A-M12KS04-WP-B1 0.4M	Stainless body
E2A 7381M	E2A-M12KS04-WP-C1 0.4M	Stainless body
E2A 7382R	E2A-S12KN08-M1-B1	Stainless body
E2A 7383G	E2A-M12KN08-WP-HI25 0.28M	Stainless body
E2A 7384E	E2A-S08KS02-M5-C1-4	Stainless body
E2A 7385C	E2A-S08LS02-M5-C1-4	Stainless body
E2A 7386A	E2A-M12KN08-M1-B1-4	Stainless body
E2A 7387M	E2A-M12KS04-M1-B1-4	Stainless body
E2A 7388H	E2A-M18LS08-M1G-D1	Stainless body

Product Code	Model name	Comments for continue
E2A 7389F	E2A-M12KS04-WP-C1-1 0.4M	Stainless body
E2A 7390M	E2A-M12KS04-WP-B1-1 0.4M	Stainless body
E2A 7391H	E2A-M18KS08-WP-B1 11M	Stainless body
E2A 7392F	E2A-M30LS15-WP-B2 10M	Stainless body
E2A 7393D	E2A-S08LS02-WP-D1 5M	Stainless body
E2A 7394B	E2A-S12KS04-M1-C1	Stainless body
E2A 7395M	E2A-M18KS08-M1J-B1 0.5M	Stainless body
E2A 7396R	E2A-S18LS08-WS-C1 2M	Stainless body
E2A 7397G	E2A-S12KS04-WS-C1 7.5M	Stainless body
E2A 7398E	E2A-M12LN05-M1-B1-TP	Stainless body
E2A 7399C	E2A-M12KN08-WP-D1 5M	Stainless body
E2A 7401R	E2A-M12KS04-M1J-B1 0.75M	Stainless body
E2A 7402G	E2A-S08KS02-WP-D1 2M	Stainless body
E2A 7403E	E2A-S12LS04-M1-B1	Stainless body
E2A 7404C	E2A-S18KS08-WP-B1 5M	Stainless body
E2A 7405A	E2A-S18LS08-M1-B1	Stainless body
E2A 7406M	E2A-M12KS04-M5-B1	Stainless body
E2A 7407H	E2A-M18KS08-M5-B1	Stainless body
E2A 7408F	E2A-S12LS04-WP-B1 2M	Stainless body
E2A 7409D	E2A-S18KS08-WP-B1 2M	Stainless body
E2A 7410H	E2A-S08KS02-WP-D2 2M	Stainless body
E2A 7411F	E2A-S08KS01-WP-B1 2M	Stainless body
E2A 7413B	E2A-M18KN10-WP-C1-1 0.8M	Stainless body
E2A 7414M	E2A-S08KS02-WP-B2-1 0.2M	Stainless body
E2A 7415R	E2A-S12KS04-WP-B1 5M	Stainless body
E2A 7416G	E2A-S30LS15-WP-B1 2M	Stainless body
E2A 7417E	E2A-M18KS08-M1G-D1	Stainless body
E2A 7418C	E2A-M12KS04-M1G-D1	Stainless body
E2A 7420E	E2A-M12KS04-M5-B2	Stainless body
E2A 7421C	E2A-M12KS04-M3-B1	Stainless body
E2A 7422A	E2A-S12KS04-M5-B1	Stainless body

Product Code	Model name	Comments for continue
E2A 7423M	E2A-M12KN08-M5-B1	Stainless body
E2A 7424H	E2A-M12KN08-M3-B1	Stainless body
E2A 7425F	E2A-M12KS04-M5-C1	Stainless body
E2A 7426D	E2A-M12KS04-M3-C1	Stainless body
E2A 7427B	E2A-M18KS08-M3-B1	Stainless body
E2A 7428M	E2A-M18KN16-M5-B1	Stainless body
E2A 7429R	E2A-M18KS08-M5-C1	Stainless body
E2A 7430B	E2A-M18KN16-M5-C1	Stainless body
E2A 7434E	E2A-M12LS04-M5-B1	Stainless body
E2A 7435C	E2A-M12LS04-M3-B1	Stainless body
E2A 7436A	E2A-M12LN08-M5-B1	Stainless body
E2A 7437M	E2A-M12LN08-M3-B1	Stainless body
E2A 7438H	E2A-M18LS08-M5-B1	Stainless body
E2A 7439F	E2A-M18LN16-M5-C1	Stainless body
E2A 7440M	E2A-S12KS04-M1-B2	Stainless body
E2A 7441H	E2A-M30KS10-WP-B1-TP 5M	Stainless body
E2A 7442F	E2A-M18LN10-WP-B1-TP 5M	Stainless body
E2A 7444B	E2A-S30KS15-M5-B1	Stainless body
E2A 7445M	E2A-S12KN05-M1-B2	Stainless body
E2A 7446R	E2A-S12LS04-M1-C1	Stainless body
E2A 7447G	E2A-S12KS04-WP-C1 2M	Stainless body
E2A 7448E	E2A-S12LS04-WP-C1 2M	Stainless body
E2A 7449C	E2A-S18KS08-M1-C1	Stainless body
E2A 7450G	E2A-S18LS08-M1-C1	Stainless body
E2A 7451E	E2A-S18KS08-WP-C1 2M	Stainless body
E2A 7452C	E2A-S18LS08-WP-C1 2M	Stainless body
E2A 7453A	E2A-S18LS08-WP-B1 2M	Stainless body
E2A 7454M	E2A-S30KS15-WP-B1 5M	Stainless body
E2A 7455H	E2A-S30KS15-WP-C1 5M	Stainless body
E2A 7456F	E2A-S30KS15-WP-B1 2M	Stainless body
E2A 7457D	E2A-S18KN16-WP-B1 5M	Stainless body

Product Code	Model name	Comments for continue
E2A 7458B	E2A-S18KN16-WP-B1 2M	Stainless body
E2A 7459M	E2A-S18KS08-WS-B1 10M	Stainless body
E2A 7460D	E2A-S12KS04-WS-B1 5M	Stainless body
E2A 7461B	E2A-S12KS04-M5-C1	Stainless body
E2A 7462M	E2A-S08KS02-M3-C1	Stainless body
E2A 7463R	E2A-S08KS02-M3-C2	Stainless body
E2A 7464G	E2A-S08KN02-M1-B1	Stainless body
E2A 7465E	E2A-S08KN04-M3-B1	Stainless body
E2A 7466C	E2A-S08LN04-M3-B1	Stainless body
E2A 7467A	E2A-S08KS02-M1G-D1	Stainless body
E2A 7468M	E2A-S08KN04-M1G-D1	Stainless body
E2A 7469H	E2A-S08KN04-WP-D1 2M	Stainless body
E2A 7470A	E2A-S08KN04-WP-D2 2M	Stainless body
E2A 7471M	E2A-S08KN04-M3-B2	Stainless body
E2A 7472H	E2A-S08KN04-M3-C1	Stainless body
E2A 7473F	E2A-S08KN02-WP-B1 2M	Stainless body
E2A 7474D	E2A-S08KS01-WP-B2 2M	Stainless body
E2A 7475B	E2A-S08KS01-WP-C1 2M	Stainless body
E2A 7476M	E2A-S08KS01-M1-B2	Stainless body
E2A 7477R	E2A-S08LS01-M5-B1	Stainless body
E2A 7478G	E2A-S08KS01-M5-B1	Stainless body
E2A 7480R	E2A-S08LS02-M5-B1-S	Stainless body
E2A 7481G	E2A-P08KS02-M5T2-B1	Stainless body
E2A 7482E	E2A-P08KS02-M5T3-B1	Stainless body
E2A 7483C	E2A-P08KS02-M5T1-B2	Stainless body
E2A 7484A	E2A-P08LS02-M5-B2	Stainless body
E2A 7485M	E2A-M18KS08-WS-B2-1	Stainless body
E2A 7487F	E2A-M12KS04-M3-B2	Stainless body
E2A 7488D	E2A-S18LS08-WP-C2 2M	Stainless body
E2A 7489B	E2A-M12KN08-M5-B2	Stainless body
E2A 7490F	E2A-M12KN08-M3-B2	Stainless body

Product Code	Model name	Comments for continue
E2A 7491D	E2A-M12KS04-M5-C2	Stainless body
E2A 7492B	E2A-S18KS08-WP-B2 5M	Stainless body
E2A 7493M	E2A-S18KN16-WP-B2 5M	Stainless body
E2A 7495G	E2A-S12LS04-WP-B2 2M	Stainless body
E2A 7496E	E2A-S12KS04-M1-C2	Stainless body
E2A 7497C	E2A-M12LN08-M3-B2	Stainless body
E2A 7498A	E2A-M12LN08-M5-C2	Stainless body
E2A 7499M	E2A-M18LS08-M3-B1	Stainless body
E2A 7500G	E2A-S12LN08-M1-B1	Stainless body
E2A 7501E	E2A-S12KS04-M5-B2	Stainless body
E2A 7502C	E2A-S18KS08-M5-B1	Stainless body
E2A 7503A	E2A-S18KS08-M5-B2	Stainless body
E2A 7504M	E2A-S12KS04-WP-B2 2M	Stainless body
E2A 7505H	E2A-S18LN16-WP-B1 2M	Stainless body
E2A 7506F	E2A-S12LS04-M1J-C1 0.5M	Stainless body
E2A 7507D	E2A-S12KN08-WP-B1 20M	Stainless body
E2A 7508B	E2A-S18KS08-M1-B2	Stainless body
E2A 7509M	E2A-S08KS02-M1G-D2	Stainless body
E2A 7510D	E2A-S08KN04-M1G-D2	Stainless body
E2A 7511B	E2A-S08LN04-M5J-B1 0.3M	Stainless body
E2A 7512M	E2A-S08LN04-M5J-B1 0.6M	Stainless body
E2A 7513R	E2A-S08KN04-WP-B1 10M	Stainless body
E2A 7514G	E2A-S08KN04-M3-C2	Stainless body
E2A 7515E	E2A-S08KN02-WP-B2 2M	Stainless body
E2A 7516C	E2A-S08KN02-WP-C2 2M	Stainless body
E2A 7517A	E2A-S08KS01-WP-C2 2M	Stainless body
E2A 7518M	E2A-S08KS01-M1-C1	Stainless body
E2A 7519H	E2A-S08LS01-WP-B1 2M	Stainless body
E2A 7520A	E2A-S08LS01-M1-B1	Stainless body
E2A 7521M	E2A-S08KS01-M5-C1	Stainless body
E2A 7522H	E2A-S08LS01-M5-C1	Stainless body

Product Code	Model name	Comments for continue
E2A 7523F	E2A-S08KS01-WP-B2 5M	Stainless body
E2A 7524D	E2A-S08LS01-M3-B1	Stainless body
E2A 7525B	E2A-S08LS01-WP-B1 5M	Stainless body
E2A 7526M	E2A-S08KS01-WP-C1 5M	Stainless body
E2A 7528G	E2A-S08KS01-M5J-B1 0.3M	Stainless body
E2A 7529E	E2A-S08KN02-M1-C1	Stainless body
E2A 7530R	E2A-S08KS02-M5-B1-2	Stainless body
E2A 7531G	E2A-S08KS02-M5-B2-2	Stainless body
E2A 7532E	E2A-P08LS02-M5-B1	Stainless body
E2A 7533C	E2A-P08LS02-M5T2-B1	Stainless body
E2A 7541D	E2A-M12KS04-WP-B3 8M	Stainless body
E2A 7544R	E2A-M18KS08-WP-B3 10M	Stainless body
E2A 7553H	E2A-M30KN20-WP-B3 2M	Stainless body
E2A 7554F	E2A-M30KN20-M1-B3	Stainless body
E2A 7576G	E2A-M30KN20-WP-C3 2M	Stainless body
E2A 7578C	E2A-M30KN20-M1-C3	Stainless body
E2A 7580E	E2A-M12KS04-WP-B3 6M	Stainless body
E2A 7581C	E2A-M30KS10-WP-C3 15M	Stainless body
E2A 7582A	E2A-M30KS10-WP-B3 15M	Stainless body
E2A 7583M	E2A-M30KS10-WP-C3 20M	Stainless body
E2A 7584H	E2A-M30KS10-WP-B3 10M	Stainless body
E2A 7585F	E2A-M18LS08-WP-B3 10M	Stainless body
E2A 7586D	E2A-M12KS04-WS-B3 2M	Stainless body
E2A 7588M	E2A-S18KS08-WP-B3 10M	Stainless body
E2A 7592R	E2A-S18LN16-M1-B3	Stainless body
E2A 7593G	E2A-S18LS08-M1-B3	Stainless body
E2A 7594E	E2A-M30LS15-WP-B3 20M	Stainless body
E2A 7595C	E2A-S12LN08-M1-B3	Stainless body
E2A 7596A	E2A-S12LN08-M1-C3	Stainless body
E2A 7597M	E2A-M18KS08-M1J-B1-L 0.5M	Stainless body
E2A 7598H	E2A-M30KS15-WP-B3 10M	Stainless body

Product Code	Model name	Comments for continue
E2A 7599F	E2A-S08LS02-WP-B3 2M	Stainless body
E2A 7600C	E2A-S08LN04-WP-B3 2M	Stainless body
E2A 7601A	E2A-S08LS02-M3-B3	Stainless body
E2A 7602M	E2A-S08LN04-M3-B3	Stainless body
E2A 7603H	E2A-M18KS08-M1-B3-4	Stainless body
E2A 7604F	E2A-S08KN04-WP-C1-51 1.1M	Stainless body
E2A 7605D	E2A-M18KS08-WS-HI	Stainless body
E2A 7606B	E2A-Z4303500	Stainless body
E2A 7607M	E2A-M12KS04-WP-HI 1M	Stainless body
E2A 7610M	E2A-S12LS04-M1-C3	Stainless body
E2A 7611R	E2A-M18LS08-M1-B1-JF	Customized
E2A 7612G	E2A-M12KN08-M1G-D1	Customized
E2A 7613E	E2A-M12KS04-M1-B1-20	Customized
E2A 7614C	E2A-M12LS04-M1-B1-20	Customized
E2A 7615A	E2A-S08KS02-M3-B1-20	Customized
E2A 7616M	E2A-M18KS08-M1-B1-20	Customized
E2A 7617H	E2A-M12KS04-M1-C1-20	Customized
E2A 7618F	E2A-M12KN08-M1-B1-20	Customized
E2A 7619D	E2A-S08KS02-M3-C1-20	Customized
E2A 7620H	E2A-M18KN16-M1-B1-20	Customized
E2A 7621F	E2A-M18KS08-M1-B1-C20	Customized
E2A 7622D	E2A-M30KS15-M1-B1-C10	Customized
E2A 7623B	E2A-M30LN30-WA-B1-54 0.5M	Customized
E2A 7624M	E2A-M18LS08-WP-B1-3 0.115M	Customized
E2A 7628C	E2A-S08LS02-WP-D2 2M	
E2A 7629A	E2A-S08LS02-WP-D2 5M	

Specifications and prices in this product news are as of the issue date and are subject to change without notice. Only main changes in specifications are described in this document. Please be sure to read the relevant catalogs, datasheets, product specifications, instructions, and manuals for precautions and necessary information when using products.