

SOLID TANTALUM ELECTROLYTIC CAPACITORS

F91

LOW ESR
Resin-molded Chip



For SMD



For High Frequency

● Compliant to the RoHS directive (2002/95/EC).



■ Type numbering system (Example : 10V 100μF)

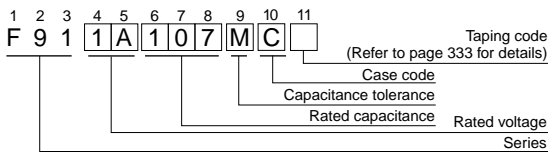

■ Drawing

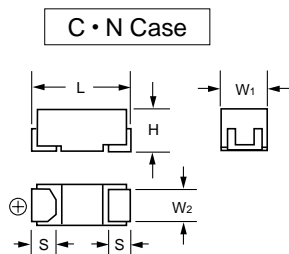

■ Dimensions

Case Code	L	W ₁	W ₂	H	S
C	6.0 ± 0.2	3.2 ± 0.2	2.2 ± 0.1	2.5 ± 0.2	1.3 ± 0.2
N	7.3 ± 0.2	4.3 ± 0.2	2.4 ± 0.1	2.8 ± 0.2	1.3 ± 0.2

(mm)

■ Marking

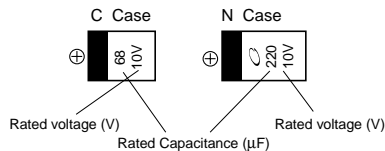

■ Standard Ratings

Cap. (μF)	Code	V		
		4	6.3	10
68	686	0G	0J	C
100	107		C	C
150	157	C	C	N
220	227	C	C · N	N
330	337	N	N	N
470	477	N	N	
680	687	N		

■ Specifications

Item	Performance Characteristics
Category	
Temperature Range	-55 to +125°C (Rated temperature : +85°C)
Capacitance Tolerance	±20%, ±10% (at 120Hz)
Dissipation Factor (120Hz)	Refer to the table below.
ESR (100kHz)	Refer to the table below.
Leakage Current	<ul style="list-style-type: none"> After 1 minute's application of rated voltage, leakage current at 20°C is not more than 0.01CV or 0.5μA, whichever is greater. After 1 minute's application of rated voltage, leakage current at 85°C is not more than 0.1CV or 5μA, whichever is greater. After 1 minute's application of derated voltage, leakage current at 125°C is not more than 0.125CV or 6.3μA, whichever is greater.
Capacitance Change by Temperature	+15% Max. (at +125°C) +10% Max. (at +85°C) -10% Max. (at -55°C)
Damp Heat (Steady State)	At 40°C 90 to 95% R.H. 500 hours (No voltage applied) Capacitance Change Within ±10% of the initial value Dissipation Factor.....Initial specified value or less Leakage Current.....Initial specified value or less
Temperature Cycles	-55°C / +125°C 30 minutes each 5 cycles Capacitance Change Within ±5% of the initial value Dissipation Factor.....Initial specified value or less Leakage Current.....Initial specified value or less
Resistance to Soldering Heat	10 seconds reflow at 260°C, 5 seconds immersion at 260°C Capacitance Change Within ±5% of the initial value Dissipation Factor.....Initial specified value or less Leakage Current.....Initial specified value or less
Surge*	After application of surge in series with a 33Ω resistor at the rate of 30 seconds ON, 30 seconds OFF, for 1000 successive test cycles at 85°C, capacitors shall meet the characteristic requirements table below. Capacitance Change---Within ±5% of the initial value Dissipation Factor.....Initial specified value or less Leakage Current.....Initial specified value or less
Endurance*	After 2000 hours' application of rated voltage in series with a 3Ω resistor at 85°C, or derated voltage in series with a 3Ω resistor at 125°C, capacitors shall meet the characteristics requirements table below. Capacitance Change.....Within ±10% of the initial value Dissipation Factor.....Initial specified value or less Leakage Current.....Initial specified value or less
Shear Test	After applying the pressure load of 5N for 10±1 seconds horizontally to the center of capacitor side body which has no electrode and has been soldered beforehand on a substrate, there shall be found neither exfoliation nor its sign at the terminal electrode. 5N (0.51kg · f) For 10±1 seconds
Terminal Strength	Keeping a capacitor surface-mounted on a substrate upside down and supporting the substrate at both of the opposite bottom points 45mm apart from the center of capacitor, the pressure strength is applied with a specified jig at the center of substrate so that the substrate may bend by 1mm as illustrated. Then, there shall be found no remarkable abnormality on the capacitor terminals. R230 45 45 1mm

* As for the surge and derated voltage at 125°C, refer to page 332 for details.

Rated Volt	Rated Capacitance (μF)	Case code	Part Number	Leakage Current (μA)	Dissipation Factor (% @ 120Hz)	ESR (mΩ @ 100kHz)
4V	150	C	F910G157MCC	6.0	12	250
	220	C	F910G227MCC	8.8	12	250
	330	N	F910G337MNC	13.2	10	100
	470	N	F910G477MNC	18.8	16	100
	680	N	F910G687MNC	27.2	18	100
6.3V	100	C	F910J107MCC	6.3	8	250
	150	C	F910J157MCC	9.5	12	250
	220	C	F910J227MCC	13.9	14	250
	220	N	F910J227MNC	13.9	10	100
	330	N	F910J337MNC	20.8	14	100
10V	470	N	F910J477MNC	29.6	16	100
	68	C	F911A686MCC	6.8	8	300
	100	C	F911A107MCC	10.0	10	250
	150	N	F911A157MNC	15.0	10	100
	220	N	F911A227MNC	22.0	12	100
	330	N	F911A337MNC	33.0	18	100

* In case of capacitance tolerance ± 10% type, [K] will be put at 9th digit of type numbering system.

F92 Resin-molded Chip, Compact Series

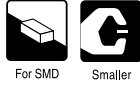

● Compliant to the RoHS directive (2002/95/EC).

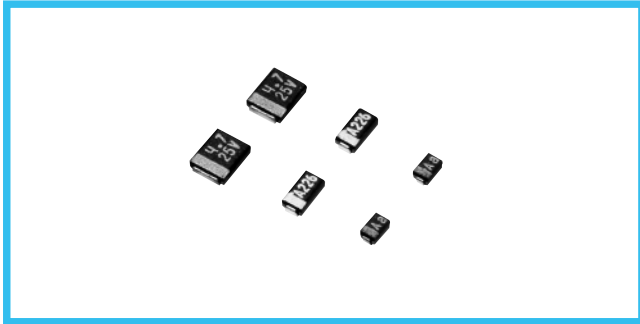

Marking

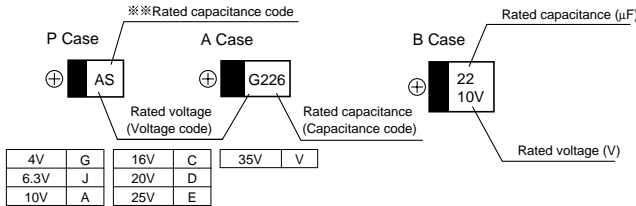

※ ※ Capacitance code of "P" case products are as shown below.

Specifications

Item	Performance Characteristics	
	P Case	A · B Case
Category	-55 to +125°C (Rated temperature : +85°C)	
Temperature Range	-55 to +125°C (Rated temperature : +85°C)	
Capacitance Tolerance	±20% (at 120Hz)	
Dissipation Factor (120Hz)	Refer to Next Page	
ESR (100kHz)	Refer to Next Page	
Leakage Current	<ul style="list-style-type: none"> After 1 minute's application of rated voltage, leakage current at 20°C is not more than 0.01CV or 0.5μA, whichever is greater. After 1 minute's application of rated voltage, leakage current at 85°C is not more than 0.1CV or 5μA, whichever is greater. After 1 minute's application of derated voltage, leakage current at 125°C is not more than 0.125CV or 6.3μA, whichever is greater. 	
Capacitance Change by Temperature	+20% Max. (at +125°C) +15% Max. (at +85°C) -15% Max. (at -55°C)	+15% Max. (at +125°C) +10% Max. (at +85°C) -10% Max. (at -55°C)
Damp Heat (Steady State)	At 40°C 90 to 95% R.H. 500 hours (No voltage applied)	
	Capacitance Change... Refer to next page (*1) Dissipation Factor...150% or less than the initial specified value Leakage Current... Initial specified value or less	Refer to next page (*1) Initial specified value or less Initial specified value or less
Temperature Cycles	-55°C / +125°C 30 minutes each 5 cycles	
	Capacitance Change... Refer to next page (*1) Dissipation Factor...150% or less than the initial specified value Leakage Current... Initial specified value or less	Refer to next page (*1) Initial specified value or less Initial specified value or less

Standard Ratings

Cap. (μF)	V		4	6.3	10	16	20	25	35	※ ※ Capacitance code
	Code	OG	0J	1A	1C	1D	1E	1V		
0.22	224								A	J
0.33	334								A	N
0.47	474					P	P · A		A	S
0.68	684					P	A			W
1	105				P	P	P · A	P · A	A	A
1.5	155				P	P	A			E
2.2	225		P		P	P · A	(P) · A	A · B	B	J
3.3	335	P	P		P · A	A			B	N
4.7	475	P	P		P · A	(P) · A · B	A · B	A · B		S
6.8	685	P	P		P · A	B				w
10	106	P · A	P · A		P · A	A · B	B			a
15	156	P	P · A		A					e
22	226	P · A	P · A		A · B	B				J
33	336	P · A	A · B		B					n
47	476	(P) · A · B	A · B		B					s
68	686	A · B								
100	107	A · B	(A) · B							
150	157	B								
220	227	(B)								

Type numbering system (Example: 6.3V 10μF)

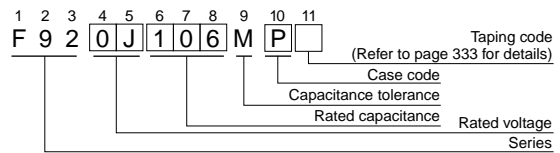

Drawing

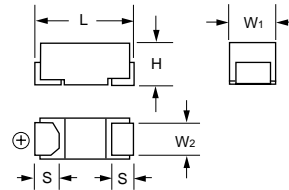

Dimensions

Case code	L	W ₁	W ₂	H	S
P	2.0 ± 0.2	1.25 ± 0.1	0.9 ± 0.1	1.1 ± 0.1	0.5 ± 0.2
A	3.2 ± 0.2	1.6 ± 0.2	1.2 ± 0.1	1.1 ± 0.1	0.8 ± 0.2
B	3.4 ± 0.2	2.8 ± 0.2	2.3 ± 0.1	1.1 ± 0.1	0.8 ± 0.2

Resistance to Soldering Heat	10 seconds reflow at 260°C, 5 seconds immersion at 260°C	Capacitance Change... Refer to next page (*1) Dissipation Factor...150% of less than the initial specified value Leakage Current... Initial specified value or less	Refer to next page (*1) Initial specified value or less Initial specified value or less
Surge*	After application of surge voltage in series with a 33Ω resistor at the rate of 30 seconds ON, 30 seconds OFF, for 1000 successive test cycles at 85°C, capacitors shall meet the characteristic requirements table below.	Capacitance Change... Refer to next page (*1) Dissipation Factor...150% or less than the initial specified value Leakage Current... Initial specified value or less	Refer to next page (*1) Initial specified value or less Initial specified value or less
Endurance*	After 2000hours' application of rated voltage in series with a 3Ω resistor at 85°C, or derated voltage in series with a 3Ω resistor at 125°C, capacitors shall meet the characteristic requirements table below.	Capacitance Change... Refer to next page (*1) Dissipation Factor...150% or less than the initial specified value Leakage Current... Initial specified value or less	After 2000hours' application of rated voltage in series with a 3Ω resistor at 85°C, or derated voltage in series with a 3Ω resistor at 125°C, capacitors shall meet the characteristic requirements table below. Capacitance Change... Refer to next page (*1) Dissipation Factor... Initial specified value or less Leakage Current... Initial specified value or less
Shear Test	After applying the pressure load of 5N for 10±1 seconds horizontally to the center of capacitor side body which has no electrode and has been soldered beforehand on a substrate, there shall be found neither exfoliation nor its sign at the terminal electrode.		 5N (0.51kg · f) For 10 ± 1 seconds
Terminal Strength	Keeping a capacitor surface-mounted on a substrate upside down and supporting the substrate at both of the opposite bottom points 45mm apart from the center of capacitor, the pressure strength is applied with a specified jig at the center of substrate so that the substrate may bend by 1mm as illustrated.		 R230 45 45 1mm

* As for the surge and derated voltage at 125°C, refer to page 332 for details.

() The series in parentheses are being developed. Please contact to your local Nichicon sales office when these series are being designed in your application.

F92

Standard Ratings

Rated Volt	Rated Capacitance (μF)	Case code	Part Number	Leakage Current (μA)	Dissipation Factor (%@120Hz)	ESR (sΩ@100kHz)	*1 ΔC/C (%)	
4V	3.3	P	F920G335MPA	0.5	8	12.0	*	
	4.7	P	F920G475MPA	0.5	8	6.0	*	
	6.8	P	F920G685MPA	0.5	10	6.0	*	
	10	P	F920G106MPA	0.5	10	6.0	*	
	10	A	F920G106MAA	0.5	8	4.0	*	
	15	P	F920G156MPA	0.6	10	5.0	*	
	22	P	F920G226MPA	0.9	20	5.0	*	
	22	A	F920G226MAA	0.9	12	2.8	*	
	33	P	F920G336MPA	1.3	20	4.0	*	
	33	A	F920G336MAA	1.3	12	2.8	*	
	47	A	F920G476MAA	1.9	18	2.8	*	
	47	B	F920G476MBA	1.9	12	1.7	*	
	68	A	F920G686MAA	2.7	25	2.8	±15	
	68	B	F920G686MBA	2.7	18	1.5	*	
	100	A	F920G107MAA	4.0	30	2.8	±15	
	100	B	F920G107MBA	4.0	18	1.3	*	
	150	B	F920G157MBA	6.0	25	1.3	±15	
	6.3V	2.2	P	F920J225MPA	0.5	8	12.0	*
3.3		P	F920J335MPA	0.5	8	12.0	*	
4.7		P	F920J475MPA	0.5	8	6.0	*	
6.8		P	F920J685MPA	0.5	10	6.0	*	
10		P	F920J106MPA	0.6	10	6.0	*	
10		A	F920J106MAA	0.6	8	4.0	*	
15		P	F920J156MPA	0.9	10	6.0	*	
15		A	F920J156MAA	0.9	8	4.0	*	
22		P	F920J226MPA	1.4	20	5.0	*	
22		A	F920J226MAA	1.4	12	2.8	*	
33		A	F920J336MAA	2.1	12	2.8	*	
33		B	F920J336MBA	2.1	12	1.7	*	
47		A	F920J476MAA	3.0	18	2.8	±15	
47		B	F920J476MBA	3.0	12	1.7	*	
100		B	F920J107MBA	6.3	20	1.3	±15	
10V		1	P	F921A105MPA	0.5	8	12.0	*
		1.5	P	F921A155MPA	0.5	8	12.0	*
		2.2	P	F921A225MPA	0.5	8	12.0	*
	3.3	P	F921A335MPA	0.5	8	12.0	*	
	3.3	A	F921A335MAA	0.5	6	7.0	*	
	4.7	P	F921A475MPA	0.5	8	6.0	*	
	4.7	A	F921A475MAA	0.5	6	4.0	*	
	6.8	P	F921A685MPA	0.7	8	6.0	*	
	6.8	A	F921A685MAA	0.7	6	4.0	*	
	10	P	F921A106MPA	1.0	14	6.0	*	
	10	A	F921A106MAA	1.0	8	4.0	*	
	15	A	F921A156MAA	1.5	8	4.0	*	
	22	A	F921A226MAA	2.2	14	4.0	±15	
	22	B	F921A226MBA	2.2	8	1.9	*	
	33	B	F921A336MBA	3.3	12	1.9	*	
	47	B	F921A476MBA	4.7	18	1.9	±15	
	16V	0.47	P	F921C474MPA	0.5	8	20.0	*
		0.68	P	F921C684MPA	0.5	8	12.0	*
1		P	F921C105MPA	0.5	8	12.0	*	
1.5		P	F921C155MPA	0.5	8	12.0	*	
2.2		P	F921C225MPA	0.5	8	12.0	*	
2.2		A	F921C225MAA	0.5	6	7.0	*	
3.3		A	F921C335MAA	0.5	6	7.0	*	
4.7		A	F921C475MAA	0.8	6	7.0	*	
4.7		B	F921C475MBA	0.8	6	3.0	*	
6.8		B	F921C685MBA	1.1	6	3.0	*	
10		A	F921C106MAA	1.6	8	7.0	±15	
10		B	F921C106MBA	1.6	6	2.0	*	
22		B	F921C226MBA	3.5	12	2.0	±15	

Rated Volt	Rated Capacitance (μF)	Case code	Part Number	Leakage Current (μA)	Dissipation Factor (%@120Hz)	ESR (sΩ@100kHz)	*1 ΔC/C (%)
20V	0.47	P	F921D474MPA	0.5	8	20.0	*
	0.47	A	F921D474MAA	0.5	4	10.0	*
	0.68	A	F921D684MAA	0.5	4	10.0	*
	1	P	F921D105MPA	0.5	8	20.0	*
	1	A	F921D105MAA	0.5	4	10.0	*
	1.5	A	F921D155MAA	0.5	6	7.4	*
	2.2	A	F921D225MAA	0.5	6	7.0	*
	4.7	A	F921D475MAA	0.9	10	7.0	±10
	4.7	B	F921D475MBA	0.9	6	3.0	*
	10	B	F921D106MBA	2.0	8	3.0	±10
25V	1	P	F921E105MPA	0.5	8	20.0	*
	1	A	F921E105MAA	0.5	6	10.0	*
	2.2	A	F921E225MAA	0.6	8	10.0	±15
	2.2	B	F921E225MBA	0.6	6	4.0	*
	4.7	A	F921E475MAA	1.2	10	7.0	±10
	4.7	B	F921E475MBA	1.2	6	3.0	*
35V	0.22	A	F921V224MAA	0.5	4	10.0	*
	0.33	A	F921V334MAA	0.5	4	10.0	*
	0.47	A	F921V474MAA	0.5	4	10.0	*
	1	A	F921V105MAA	0.5	6	10.0	*
	2.2	B	F921V225MBA	0.8	6	4.0	±10
	3.3	B	F921V335MBA	1.2	10	4.0	±10

1 : ΔC/C Marked ""

Item	P Case (%)	A , B Case(%)
Damp Heat	±20	±10
Temperature cycles	±10	± 5
Resistance soldering heat	±10	± 5
Surge	±10	± 5
Endurance	±10	±10

We can consider the type of compliance to AEC-Q200. Please contact to your local Nichicon sales office when these series are being designed in your application.

F93 Resin-molded Chip, Standard Series



● Compliant to the RoHS directive (2002/95/EC).

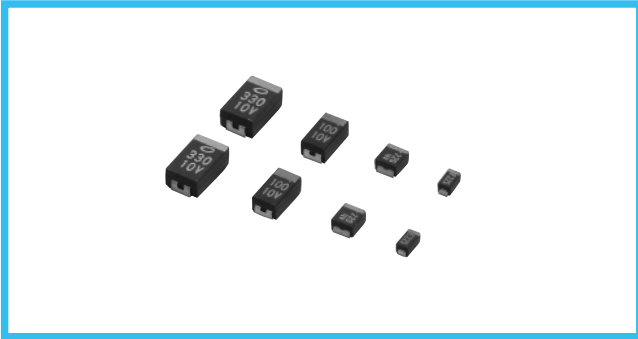

■ Type numbering system (Example: 10V 10μF)

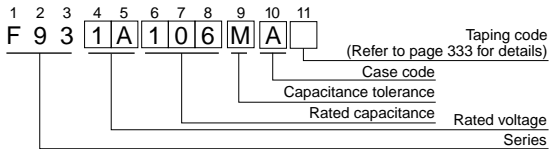

■ Drawing

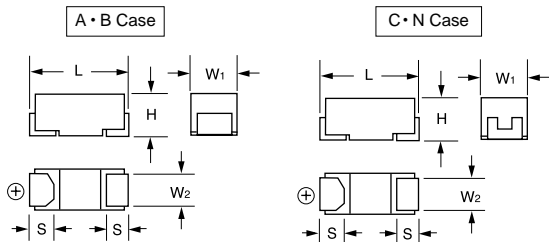

■ Dimensions

Case code	L	W ₁	W ₂	H	S
A	3.2 ± 0.2	1.6 ± 0.2	1.2 ± 0.1	1.6 ± 0.2	0.8 ± 0.2
B	3.5 ± 0.2	2.8 ± 0.2	2.2 ± 0.1	1.9 ± 0.2	0.8 ± 0.2
C	6.0 ± 0.2	3.2 ± 0.2	2.2 ± 0.1	2.5 ± 0.2	1.3 ± 0.2
N	7.3 ± 0.2	4.3 ± 0.2	2.4 ± 0.1	2.8 ± 0.2	1.3 ± 0.2

■ Marking

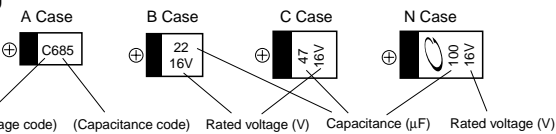

4V	G	20V	D
6.3V	J	25V	E
10V	A	35V	V
16V	C		

■ Specifications

Item	Performance Characteristics
Category	-55 to +125°C (Rated temperature : +85°C)
Temperature Range	-55 to +125°C (Rated temperature : +85°C)
Capacitance Tolerance	±20%, ±10% (at 120Hz)
Dissipation Factor (120Hz)	Refer to next page
ESR (100kHz)	Refer to next page
Leakage Current	<ul style="list-style-type: none"> After 1 minute's application of rated voltage, leakage current at 20°C is not more than 0.01CV or 0.5μA, whichever is greater. After 1 minute's application of rated voltage, leakage current at 85°C is not more than 0.1CV or 5μA, whichever is greater. After 1 minute's application of derated voltage, leakage current at 125°C is not more than 0.125CV or 6.3μA, whichever is greater.
Capacitance Change by Temperature	+15% Max. (at +125°C) +10% Max. (at +85°C) -10% Max. (at -55°C)
Damp Heat (Steady State)	At 40°C 90 to 95% R.H. 500 hours (No voltage applied) Capacitance Change...Refer to next page (* 1) Dissipation Factor...Initial specified value or less Leakage Current...Initial specified value or less
Temperature Cycles	-55°C / +125°C 30 minutes each 5 cycles Capacitance Change...Refer to next page (* 1) Dissipation Factor...Initial specified value or less Leakage Current...Initial specified value or less
Resistance to Soldering Heat	10 seconds reflow at 260°C, 5 seconds immersion at 260°C Capacitance Change...Refer to next page (* 1) Dissipation Factor...Initial specified value or less Leakage Current...Initial specified value or less
Surge*	After application of surge voltage in series with a 33Ω resistor at the rate of 30 seconds ON, 30 seconds OFF, for 1000 successive test cycles at 85°C, capacitors shall meet the characteristic requirements table below. Capacitance Change...Refer to next page (* 1) Dissipation Factor...Initial specified value or less Leakage Current...Initial specified value or less
Endurance*	After 2000 hours' application of rated voltage in series with a 3Ω resistor at 85°C, or derated voltage in series with a 3Ω resistor at 125°C, capacitors shall meet the characteristic requirements table below. Capacitance Change...Refer to next page (* 1) Dissipation Factor...Initial specified value or less Leakage Current...Initial specified value or less
Shear Test	After applying the pressure load of 5N for 10±1 seconds horizontally to the center of capacitor side body which has no electrode and has been soldered beforehand on a substrate, there shall be found neither exfoliation nor its sign at the terminal electrode. 5N (0.51kg · f) For 10±1 seconds
Terminal Strength	Keeping a capacitor surface-mounted on a substrate upside down and supporting the substrate at both of the opposite bottom points 45mm apart from the center of capacitor, the pressure strength is applied with a specified jig at the center of substrate so that the substrate may bend by 1mm as illustrated. Then, there shall be found no remarkable abnormality on the capacitor terminals. R230 20 45 45 1mm

* As for the surge and derated voltage at 125°C, refer to page 332 for details.

We can supply the type of compliance to AEC-Q200. Please contact to your local Nichicon sales office when these series are being designed in your application.

■ Standard Ratings

Cap. (μF)	V							
	Code	4	6.3	10	16	20	25	35
0.68	684	OG	OJ	1A	1C	1D	1E	1V
1	105				A		A	A
1.5	155						A	A
2.2	225				A	A	A	A · B
3.3	335				A	A	A	B
4.7	475				A	A	A · B	A · B
6.8	685			A	A	A · B	A · B	C
10	106		A	A	A · B	A · B	B · C	C
15	156		A	A	A · B	C	C	N
22	226	A	A	A · B	A · B · C	B · C	C · N	N
33	336	A	A	A · B	B · C	C · N	N	
47	476	A	A · B	A · B · C	(B) · C · N	C · N	N	
68	686	A	A · B	B · C	N	(N)		
100	107	A · B	A · B · C	B · C · N	C · N			
150	157	B	B · C	C · N	N			
220	227	(A) · B · C	B · C · N	N	N			
330	337	C	N	N				
470	477	N	N					
680	687	N						

() The series in parentheses are being developed. Please contact to your local Nichicon sales office when these series are being designed in your application.

F93

Standard Ratings

Rated Volt	Rated Capacitance (μF)	Case code	Part Number	Leakage Current (μA)	Dissipation Factor (%@120Hz)	ESR (Ω@100kHz)	*1 ΔC/C (%)
4V	22	A	F930G226MAA	0.9	6	2.5	*
	33	A	F930G336MAA	1.3	8	2.5	*
	47	A	F930G476MAA	1.9	18	2.5	*
	68	A	F930G686MAA	2.7	24	2.5	*
	100	A	F930G107MAA	4.0	30	2.0	*
	100	B	F930G107MBA	4.0	14	0.9	*
	150	B	F930G157MBA	6.0	16	0.7	*
	220	B	F930G227MBA	8.8	18	0.7	*
	220	C	F930G227MCC	8.8	12	0.7	*
	330	C	F930G337MCC	13.2	14	0.7	*
	470	N	F930G477MNC	18.8	16	0.3	*
	680	N	F930G687MNC	27.2	18	0.3	*
6.3V	10	A	F930J106MAA	0.6	6	3.0	*
	15	A	F930J156MAA	0.9	6	2.9	*
	22	A	F930J226MAA	1.4	8	2.5	*
	33	A	F930J336MAA	2.1	8	2.5	*
	47	A	F930J476MAA	3.0	18	2.5	*
	47	B	F930J476MBA	3.0	6	1.0	*
	68	A	F930J686MAA	4.3	20	2.0	*
	68	B	F930J686MBA	4.3	8	1.0	*
	100	A	F930J107MAA	6.3	35	2.0	±15
	100	B	F930J107MBA	6.3	14	0.9	*
	100	C	F930J107MCC	6.3	8	0.7	*
	150	B	F930J157MBA	9.5	18	0.9	*
	150	C	F930J157MCC	9.5	12	0.7	*
	220	B	F930J227MBA	13.9	30	1.2	±15
	220	C	F930J227MCC	13.9	14	0.7	*
	220	N	F930J227MNC	13.9	10	0.5	*
	330	N	F930J337MNC	20.8	14	0.5	*
	470	N	F930J477MNC	29.6	16	0.3	*
10V	6.8	A	F931A685MAA	0.7	6	3.5	*
	10	A	F931A106MAA	1.0	6	3.0	*
	15	A	F931A156MAA	1.5	8	2.9	*
	22	A	F931A226MAA	2.2	12	2.5	*
	22	B	F931A226MBA	2.2	6	1.9	*
	33	A	F931A336MAA	3.3	18	2.5	*
	33	B	F931A336MBA	3.3	8	1.4	*
	47	A	F931A476MAA	4.7	40	2.0	±15
	47	B	F931A476MBA	4.7	8	1.0	*
	47	C	F931A476MCC	4.7	6	0.9	*
	68	B	F931A686MBA	6.8	12	0.9	±15
	68	C	F931A686MCC	6.8	8	0.8	*
	100	B	F931A107MBA	10.0	18	1.2	±15
	100	C	F931A107MCC	10.0	10	0.7	*
	100	N	F931A107MNC	10.0	8	0.6	*
	150	C	F931A157MCC	15.0	14	0.7	*
	150	N	F931A157MNC	15.0	10	0.6	*
	220	N	F931A227MNC	22.0	12	0.5	*
330	N	F931A337MNC	33.0	18	0.5	*	

1 : ΔC/C Marked ""

Item	A·B·C·N Case (%)
Damp Heat	±10
Temperature cycles	±5
Resistance soldering heat	±5
Surge	±5
Endurance	±10

Rated Volt	Rated Capacitance (μF)	Case code	Part Number	Leakage Current (μA)	Dissipation Factor (%@120Hz)	ESR (Ω@100kHz)	*1 ΔC/C (%)
16V	1	A	F931C105MAA	0.5	4	7.5	*
	2.2	A	F931C225MAA	0.5	4	5.0	*
	3.3	A	F931C335MAA	0.5	4	4.5	*
	4.7	A	F931C475MAA	0.8	6	4.0	*
	6.8	A	F931C685MAA	1.1	6	3.5	*
	10	A	F931C106MAA	1.6	6	3.0	*
	10	B	F931C106MBA	1.6	6	2.0	*
	15	A	F931C156MAA	2.4	10	3.0	*
	15	B	F931C156MBA	2.4	6	2.0	*
	22	A	F931C226MAA	3.5	15	3.0	±15
	22	B	F931C226MBA	3.5	8	1.9	*
	22	C	F931C226MCC	3.5	6	1.1	*
	33	B	F931C336MBA	5.3	8	1.9	*
	33	C	F931C336MCC	5.3	6	1.1	*
	47	C	F931C476MCC	7.5	8	0.9	*
	47	N	F931C476MNC	7.5	6	0.7	*
	68	N	F931C686MNC	10.9	6	0.6	*
	100	C	F931C107MCC	16.0	15	0.7	±10
	100	N	F931C107MNC	16.0	10	0.6	*
	150	N	F931C157MNC	24.0	15	0.6	*
	220	N	F931C227MNC	35.2	25	0.7	±10
	20V	2.2	A	F931D225MAA	0.5	4	5.0
3.3		A	F931D335MAA	0.7	4	4.5	*
4.7		A	F931D475MAA	0.9	6	3.0	*
4.7		B	F931D475MBA	0.9	6	2.8	*
6.8		A	F931D685MAA	1.4	6	3.5	*
6.8		B	F931D685MBA	1.4	6	2.5	*
10		A	F931D106MAA	2.0	8	3.5	*
10		B	F931D106MBA	2.0	6	2.1	*
15		C	F931D156MCC	3.0	6	1.2	*
22		B	F931D226MBA	4.4	8	1.9	*
25V	22	C	F931D226MCC	4.4	8	1.1	*
	33	C	F931D336MCC	6.6	8	1.1	*
	33	N	F931D336MNC	6.6	6	0.7	*
	47	C	F931D476MCC	9.4	10	1.1	*
	47	N	F931D476MNC	9.4	8	0.7	*
	1	A	F931E105MAA	0.5	4	7.5	*
	1.5	A	F931E155MAA	0.5	4	6.7	*
	2.2	A	F931E225MAA	0.6	6	6.3	*
	3.3	A	F931E335MAA	0.8	6	6.0	*
	4.7	A	F931E475MAA	1.2	8	4.0	*
4.7	B	F931E475MBA	1.2	6	2.8	*	
35V	10	B	F931E106MBA	2.5	12	1.9	*
	10	C	F931E106MCC	2.5	6	1.5	*
	15	C	F931E156MCC	3.8	8	1.2	*
	22	C	F931E226MCC	5.5	8	1.1	*
	22	N	F931E226MNC	5.5	6	0.7	*
	33	N	F931E336MNC	8.3	8	0.7	*
	47	N	F931E476MNC	11.8	8	0.7	*
	0.68	A	F931V684MAA	0.5	4	7.6	*
	1	A	F931V105MAA	0.5	4	7.5	*
	1.5	A	F931V155MAA	0.5	6	7.5	*
2.2	A	F931V225MAA	0.8	6	7.0	*	
2.2	B	F931V225MBA	0.8	4	3.8	*	
3.3	B	F931V335MBA	1.2	4	3.5	*	
4.7	B	F931V475MBA	1.6	8	3.1	*	
4.7	C	F931V475MCC	1.6	6	1.8	*	
6.8	C	F931V685MCC	2.4	6	1.8	*	
10	C	F931V106MCC	3.5	6	1.6	*	
15	N	F931V156MNC	5.3	6	0.7	*	
22	N	F931V226MNC	7.7	8	0.7	*	

* In case of capacitance tolerance ±10% type, [K] will be put at 9th digit of type numbering system.

SOLID TANTALUM ELECTROLYTIC CAPACITORS

F97

Resin-molded Chip,
High Reliability
(High temperature /
moisture resistance) Series

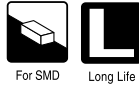

- Compliant to the RoHS directive (2002/95/EC).
- Compliant to AEC-Q200.

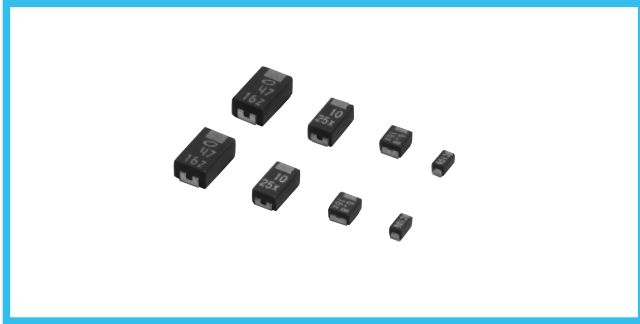

Applications

- Automotive electronics(Engine ECU)
- Industrial equipment

Type numbering system (Example : 16V 3.3μF)

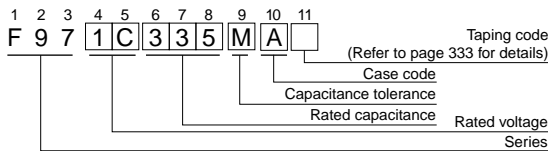

Drawing

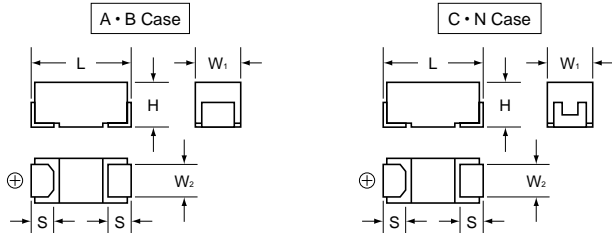

Dimensions

Case code	L	W ₁	W ₂	H	S
A	3.2 ± 0.2	1.6 ± 0.2	1.2 ± 0.1	1.6 ± 0.2	0.8 ± 0.2
B	3.5 ± 0.2	2.8 ± 0.2	2.2 ± 0.1	1.9 ± 0.2	0.8 ± 0.2
C	6.0 ± 0.2	3.2 ± 0.2	2.2 ± 0.1	2.5 ± 0.2	1.3 ± 0.2
N	7.3 ± 0.2	4.3 ± 0.2	2.4 ± 0.1	2.8 ± 0.2	1.3 ± 0.2

Marking

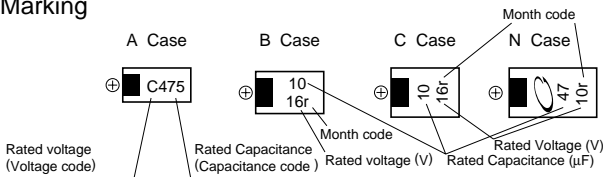

Standard ratings

Cap.(μF)	V	6.3	10	16	20	25	35
0.47	Code	0J	1A	1C	1D	1E	1V
0.47	474						A
0.68	684				A	A	A
1	105				A	A	(A)
1.5	155			A	A		(A) · B
2.2	225		A	A	A	(A) · B	B
3.3	335	A	A	A	B	B	(B) · C
4.7	475	A	A · B	A · B	A · B	(B) · C	C
6.8	685	A · B	B	B	(B) · C	C	(C) · N
10	106		A · B	A · B · C	(B) · C	C · N	N
15	156	B	B	(B) · C	N	(C) · N	
22	226	A · B	A · B	B · C · N	C · N	(N)	
33	336	A · C	B · C · N	B · C · N		(N)	
47	476	B · C	(B) · C · N	(C) · N			
68	686	N	N				
100	107	N	(C) · (N)				

Specifications

Item	Performance Characteristics
Category Temperature Range	-55 to +125°C (Rated temperature : +85°C)
Capacitance Tolerance	±20%, ±10% (at 120Hz)
Dissipation Factor	Refer to next page
ESR (100kHz)	Refer to next page
Leakage Current*	<ul style="list-style-type: none"> • After 1 minute's application of rated voltage,leakage current at 20°C is not more than 0.01CV or 0.5μA, whichever is greater. • After 1 minute's application of rated voltage,leakage current at 85°C is not more than 0.1CV or 5μA, whichever is greater. • After 1 minute's application of derated voltage,leakage current at 125°C is not more than 0.125CV or 6.3μA, whichever is greater.
Capacitance Change by Temperature	+15% Max. (at +125°C) +10% Max. (at +85°C) -10% Max. (at -55°C)
Damp Heat (Steady State)	At 85°C, 85% R.H.,For 1000 hours (No voltage applied) Capacitance Change Within ±10% of the initial value Dissipation Factor Initial specified value or less Leakage Current 125% or less than the initial specified value
Load Humidity	After 500 hour's application of rated voltage in series with a 33Ω resistor at 60°C, 90 to 95% R.H.,capacitors meet the characteristics requirements table below. Capacitance Change Within ±10% of the initial value Dissipation Factor Initial specified value or less Leakage Current 125% or less than the initial specified value
Temperature Cycles	At -55°C / +125°C,For 30 minutes each,1000 cycles Capacitance Change Within ±5% of the initial value Dissipation Factor Initial specified value or less Leakage Current Initial specified value or less
Resistance to Soldering Heat	10 seconds reflow at 260°C, 5 seconds immersion at 260°C. Capacitance Change Within ±5% of the initial value Dissipation Factor Initial specified value or less Leakage Current Initial specified value or less
Solderability	After immersing capacitors completely into a solder pot at 245°C for 2 to 3 seconds,more than 3/4 of their electrode area shall remain covered with new solder.
Surge*	After application of surge in series with a 33Ω resistor at the rate of 30 seconds ON, 30 seconds OFF,for 1000 successive test cycles at 85°C,capacitors shall meet the characteristic requirements table below. Capacitance Change Within ±5% of the initial value Dissipation Factor Initial specified value or less Leakage Current Initial specified value or less
Endurance*	After 2000 hours' application of rated voltage in series with a 3Ω resistor at 85°C,or derated voltage in series with a 3Ω resistor at 125°C,capacitors shall meet the characteristic requirements table below. Capacitance Change Within ±10% of the initial value Dissipation Factor Initial specified value or less Leakage Current Initial specified value or less
Shear Test	After applying the pressure load of 5N for 10 ± 1 seconds horizontally to the center of capacitor side body which has no electrode and has been soldered beforehand on a substrate, there shall be found neither exfoliation nor its sign at the terminal electrode.
Terminal Strength	Keeping a capacitor surface-mounted on a substrate upside down and supporting the substrate at both of the opposite bottom points 45mm apart from the center of capacitor, the pressure strength is applied with a specified jig at the center of the substrate so that substrate may bend by 1mm as illustrated. Then, there shall be found no remarkable abnormality on the capacitor terminals.

* As for the surge and derated voltage at 125°C, refer to page 332 for details.

() The series in parentheses are being developed.

Please contact to your local Nichicon sales office when these series are being designed in your application.

F97

Standard Ratings

Rated Volt	Rated Capacitance (μF)	Case code	Part Number	Leakage Current (μA)	Dissipation Factor (%@120Hz)	ESR (Ω@100kHz)
6.3V	3.3	A	F970J335MAA	0.5	4	4.5
	4.7	A	F970J475MAA	0.5	6	4.0
	6.8	A	F970J685MAA	0.5	6	3.5
	6.8	B	F970J685MBA	0.5	6	2.5
	15	B	F970J156MBA	0.9	6	2.0
	22	A	F970J226MAA	1.4	12	2.5
	22	B	F970J226MBA	1.4	8	1.9
	33	A	F970J336MAA	2.1	12	2.5
	33	C	F970J336MCC	2.1	6	1.1
	47	B	F970J476MBA	3.0	8	1.0
	47	C	F970J476MCC	3.0	6	0.9
	68	N	F970J686MNC	4.3	6	0.6
	100	N	F970J107MNC	6.3	8	0.6
	10V	2.2	A	F971A225MAA	0.5	4
3.3		A	F971A335MAA	0.5	4	4.5
4.7		A	F971A475MAA	0.5	6	4.0
4.7		B	F971A475MBA	0.5	6	2.8
6.8		B	F971A685MBA	0.7	6	2.5
10		A	F971A106MAA	1.0	6	3.0
10		B	F971A106MBA	1.0	6	2.0
15		B	F971A156MBA	1.5	6	2.0
22		A	F971A226MAA	2.2	15	3.0
22		B	F971A226MBA	2.2	8	1.9
33		B	F971A336MBA	3.3	8	1.9
33		C	F971A336MCC	3.3	6	1.1
33		N	F971A336MNC	3.3	6	0.7
47		C	F971A476MCC	4.7	8	0.9
47	N	F971A476MNC	4.7	6	0.7	
68	N	F971A686MNC	6.8	6	0.6	
16V	1.5	A	F971C155MAA	0.5	4	6.3
	2.2	A	F971C225MAA	0.5	4	5.0
	3.3	A	F971C335MAA	0.5	4	4.5
	4.7	A	F971C475MAA	0.8	8	4.0
	4.7	B	F971C475MBA	0.8	6	2.8
	6.8	B	F971C685MBA	1.1	6	2.5
	10	A	F971C106MAA	1.6	8	3.5
	10	B	F971C106MBA	1.6	6	2.1
	10	C	F971C106MCC	1.6	6	1.5
	15	C	F971C156MCC	2.4	6	1.2
	22	B	F971C226MBA	3.5	8	1.9
	22	C	F971C226MCC	3.5	8	1.1
	22	N	F971C226MNC	3.5	6	0.7
	33	B	F971C336MBA	5.3	10	2.1
33	C	F971C336MCC	5.3	8	1.1	
33	N	F971C336MNC	5.3	6	0.7	
47	N	F971C476MNC	7.5	8	0.7	
20V	0.68	A	F971D684MAA	0.5	4	7.6
	1	A	F971D105MAA	0.5	4	7.5
	1.5	A	F971D155MAA	0.5	4	6.7
	2.2	A	F971D225MAA	0.5	6	6.3
	3.3	B	F971D335MBA	0.7	4	3.1
	4.7	A	F971D475MAA	0.9	8	4.0
	4.7	B	F971D475MBA	0.9	6	2.8
	6.8	C	F971D685MCC	1.4	6	1.8
	10	C	F971D106MCC	2.0	6	1.5
	15	N	F971D156MNC	3.0	6	0.7
	22	C	F971D226MCC	4.4	8	1.1
	22	N	F971D226MNC	4.4	6	0.7

Rated Volt	Rated Capacitance (μF)	Case code	Part Number	Leakage Current (μA)	Dissipation Factor (%@120Hz)	ESR (Ω@100kHz)
25V	0.68	A	F971E684MAA	0.5	4	7.6
	1	A	F971E105MAA	0.5	4	7.5
	2.2	B	F971E225MBA	0.6	4	3.8
	3.3	B	F971E335MBA	0.8	4	3.5
	4.7	C	F971E475MCC	1.2	6	1.8
	6.8	C	F971E685MCC	1.7	6	1.8
	10	C	F971E106MCC	2.5	6	1.6
	10	N	F971E106MNC	2.5	6	1.0
	15	N	F971E156MNC	3.8	6	0.7
	35V	0.47	A	F971V474MAA	0.5	4
0.68		A	F971V684MAA	0.5	4	7.6
1.5		B	F971V155MBA	0.5	4	4.0
2.2		B	F971V225MBA	0.8	4	3.8
3.3		C	F971V335MCC	1.2	4	2.0
4.7		C	F971V475MCC	1.6	6	1.8
6.8		N	F971V685MNC	2.4	6	1.0
10	N	F971V106MNC	3.5	6	1.0	

※ In case of capacitance tolerance ±10% type, [K] will be put at 9th digit of type numbering system.



Conformal coated Chip, For Mobile Audio

- Compliant to the RoHS directive (2002/95/EC).



Applications

- Mobile Audio Player
- Mobile phone
- Smartphone
- Wireless Microphone System

Feature

- Rich sound in the bass register and clear sound. Materials are strictly selected to achieve high level sound. F95 series has no lead-frame, and no vibration factor.
- Low ESR, Low ESL
- Line up miniature size and high capacitance, necessary to mobile design.

Type numbering system (Example : 4V 220μF)

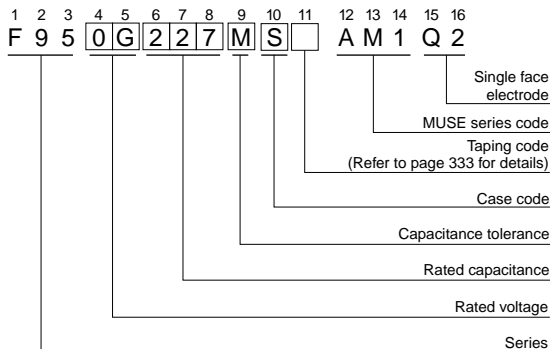

Specifications

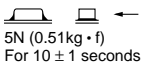
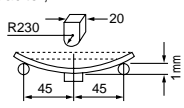
Item	Performance Characteristics
Category	
Temperature Range	-55 to +125°C (Rated temperature : +85°C)
Capacitance Tolerance	±20%, ±10% (at 120Hz)
Dissipation Factor (at 120Hz)	Refer to next page
ESR(100kHz)	Refer to next page
Leakage Current	Refer to next page Provided that ● After 1 minute's application of rated voltage, leakage current at 85°C, 10 times or less than 20°C specified value. ● After 1 minute's application of rated voltage, leakage current at 125°C, 12.5 times or less than 20°C specified value.
Capacitance Change by Temperature	+15% Max. (at +125°C) +10% Max. (at +85°C) -10% Max. (at -55°C)
Damp Heat (Steady State)	At 40°C, 90 to 95% R.H., For 500 hours (No voltage applied) Capacitance Change Refer to next page (*1) Dissipation Factor Initial specified value or less Leakage Current Initial specified value or less
Temperature Cycles	At -55°C / +125°C, 30 minutes each, For 5 cycles, Capacitance Change Refer to next page (*1) Dissipation Factor Initial specified value or less Leakage Current Initial specified value or less
Resistance to Soldering Heat	10 seconds reflow at 260°C, 10 seconds immersion at 260°C Capacitance Change Refer to next page (*1) Dissipation Factor Initial specified value or less Leakage Current Initial specified value or less
Surge*	After application of surge voltage in series with a 33Ω resistor at the rate of 30 seconds ON, 30 seconds OFF, for 1000 successive test cycles at 85°C, capacitors shall meet the characteristic requirements table below. Capacitance Change Refer to next page (*1) Dissipation Factor Initial specified value or less Leakage Current Initial specified value or less
Endurance*	After 2000 hours' application of rated voltage at 85°C, capacitors shall meet the characteristic requirements table below. Capacitance Change Refer to next page (*1) Dissipation Factor Initial specified value or less Leakage Current Initial specified value or less
Shear Test	After applying the pressure load of 5N for 10 ± 1 seconds horizontally to the center of capacitor side body which has no electrode and has been soldered beforehand on a substrate, there shall be found neither exfoliation nor its sign at the terminal electrode. 
Terminal Strength	Keeping a capacitor surface-mounted on a substrate upside down and supporting the substrate at both of the opposite bottom points 45mm apart from the center of capacitor, the pressure strength is applied with a specified jig at the center of substrate so that the substrate may bend by 1mm as illustrated. Then, there shall be found no remarkable abnormality on the capacitor terminals. 

* As for the surge voltage, refer to page 332 for details.

Drawing

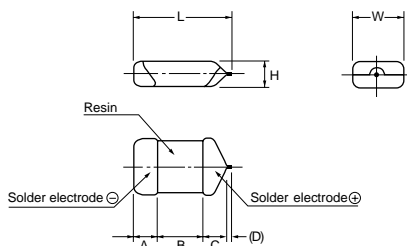

Single-side electrodes
 (Both electrodes at bottom side only)

Dimensions

Case code	L	W	H	A	B	C	(D)
P	2.2 ± 0.3	1.25 ± 0.3	1.0 ± 0.2	0.6 ± 0.3	0.8 ± 0.3	0.8 ± 0.3	(0.2)
S	3.2 ± 0.3	1.6 ± 0.3	1.0 ± 0.2	0.8 ± 0.3	1.2 ± 0.3	0.8 ± 0.3	(0.2)
A	3.2 ± 0.3	1.7 ± 0.3	1.4 ± 0.2	0.8 ± 0.3	1.2 ± 0.3	0.8 ± 0.3	(0.2)
T	3.5 ± 0.2	2.7 ± 0.2	1.0 ± 0.2	0.8 ± 0.2	1.2 ± 0.2	1.1 ± 0.2	(0.2)
B	3.5 ± 0.2	2.8 ± 0.2	1.8 ± 0.2	0.8 ± 0.3	1.2 ± 0.3	1.1 ± 0.3	(0.2)

D dimension only for reference

nichicon MUSE F95

Standard Ratings

Cap. (μF)	V	4	6.3	10
	Code	0G	0J	1A
68	686	S	S	B
100	107	S	S • T	B
150	157	S	(A)	
220	227	(P) • S • T	(A) • (T) • B	
330	337	T	B	
470	477	(T) • B	(B)	
680	687	(T) • (B)		

() The series in parentheses are being developed.

Please contact to your local Nichicon sales office when these series are being designed in your application.

Marking

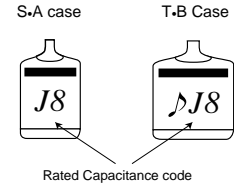

μF	68	100	150	220	330	470	680
code	W7	A8	E8	J8	N8	S8	W8

P case - No marking on part.

Standard Ratings

Rated Volt	Rated Capacitance (μF)	Case code	Part Number	*2 Leakage Current (μA)	Dissipation Factor (%@120Hz)	ESR (Ω@100kHz)	*1 ΔC/C (%)
4V	68	S	F950G686MSAAM1Q2	2.7	10	0.8	*
	100	S	F950G107MSAAM1Q2	4.0	14	0.8	*
	150	S	F950G157MSAAM1Q2	6.0	22	0.8	± 15
	220	S	F950G227MSAAM1Q2	8.8	30	0.8	± 15
	220	T	F950G227MTAAM1Q2	8.8	25	0.6	*
	330	T	F950G337MTAAM1Q2	13.2	40	0.8	± 20
	470	B	F950G477MBAAM1Q2	18.8	40	0.4	± 20
6.3V	68	S	F950J686MSAAM1Q2	4.3	14	0.9	*
	100	S	F950J107MSAAM1Q2	6.3	20	0.9	± 15
	100	T	F950J107MTAAM1Q2	6.3	14	0.6	*
	220	B	F950J227MBAAM1Q2	13.9	30	0.4	*
	330	B	F950J337MBAAM1Q2	20.8	35	0.6	± 20
10V	68	B	F951A686MBAAM1Q2	6.8	12	0.4	*
	100	B	F951A107MBAAM1Q2	10.0	14	0.4	*

※ In case of capacitance tolerance ± 10% type, [K] will be put at 9th digit of type numbering system.

1 : ΔC/C Marked ""

Item	S • A • T • B Case (%)
Damp Heat	±10
Temperature cycles	±5
Resistance soldering heat	±5
Surge	±5
Endurance	±10

*2 : Leakage Current

After 1 minute's application of rated voltage, leakage current at 20°C.

SOLID TANTALUM ELECTROLYTIC CAPACITORS

F95

Conformal coated
Chip

FRAMELESS™



For SMD



Smaller



For High
Frequency



- Compliant to the RoHS directive (2002/95/EC).

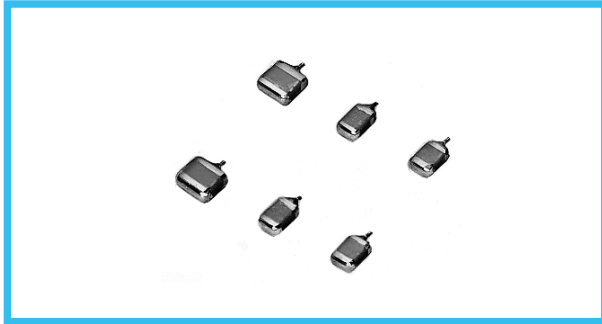

Applications

- Smartphone
- Wireless module
- Tablet PC
- e-book

Type numbering system (Example : 4V 330µF)

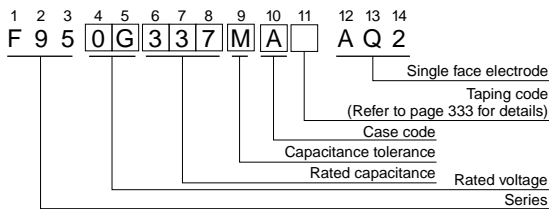

Drawing

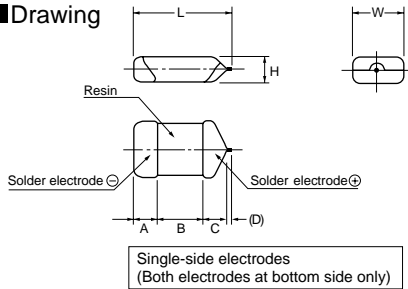

Dimensions

Case code	L	W	H	A	B	C	(D)
R	2.2 ± 0.3	1.25 ± 0.3	0.65MAX.	0.6 ± 0.3	0.8 ± 0.3	0.5MIN	(0.2)
P	2.2 ± 0.3	1.25 ± 0.3	1.0 ± 0.2	0.6 ± 0.3	0.8 ± 0.3	0.8 ± 0.3	(0.2)
Q	3.2 ± 0.2	1.6 ± 0.2	0.8 ± 0.2	0.8 ± 0.2	1.2 ± 0.2	0.8 ± 0.2	(0.2)
S	3.2 ± 0.3	1.6 ± 0.3	1.0 ± 0.2	0.8 ± 0.3	1.2 ± 0.3	0.8 ± 0.3	(0.2)
A	3.2 ± 0.3	1.7 ± 0.3	1.4 ± 0.2	0.8 ± 0.3	1.2 ± 0.3	0.8 ± 0.3	(0.2)
T	3.5 ± 0.2	2.7 ± 0.2	1.0 ± 0.2	0.8 ± 0.2	1.2 ± 0.2	1.1 ± 0.2	(0.2)
B	3.5 ± 0.2	2.8 ± 0.2	1.8 ± 0.2	0.8 ± 0.3	1.2 ± 0.3	1.1 ± 0.3	(0.2)

D dimension only for reference

Standard Ratings

Cap. (µF)	Code	V							
		4	6.3	10	16	20	25	35	
1	105	0G	0J	1A	1C	1D	1E	1V	
1.5	155						R	P · S	
2.2	225					P	R · P	A	
3.3	335								
4.7	475				R · P	S · A	P · Q · S · A	B	
6.8	685						(Q) · (S)		
10	106			R · P	P · Q · S · A	S · A · B	A · (T) · B		
15	156			P	S · A				
22	226		R	P · Q · S · A	Q · S · A · T · B	B			
33	336		(R) · P	P · Q · S · A	(A) · T · B				
47	476	(R)	P	P · (Q) · S · A · T · B	B				
68	686		P	B					
100	107	P · S · A	P · Q · S · A · T · B	(S) · A · T · B					
150	157	P · B	B						
220	227	(P) · Q · S · A · T · B	(S) · (A) · (T) · B						
330	337	(P) · (S) · A · T · B	B						
470	477	(P) · (A) · (T) · B	(B)						
680	687	(T)							

() The series in parentheses are being developed.
Please contact to your local Nichicon sales office when these series are being designed in your application.

Specifications

Item	Performance Characteristics
Category	
Temperature Range	-55 to +125°C (Rated temperature : +85°C)
Capacitance Tolerance	±20%, ±10% (at 120Hz) (However R · P Case ±20%)
Dissipation Factor (at 120Hz)	Refer to next page
ESR(100kHz)	Refer to next page
Leakage Current	Refer to next page Provided that ● After 1 minute's application of rated voltage, leakage current at 85°C, 10 times or less than 20°C specified value. ● After 1 minute's application of rated voltage, leakage current at 125°C, 12.5 times or less than 20°C specified value.
Capacitance Change by Temperature	+15% Max. (at +125°C) +10% Max. (at +85°C) -10% Max. (at -55°C)
Damp Heat (Steady State)	At 40°C, 90 to 95% R.H., For 500 hours (No voltage applied) Capacitance Change Refer to next page (*1) Dissipation Factor Initial specified value or less Leakage Current Initial specified value or less
Temperature Cycles	At -55°C / +125°C, 30 minutes each, For 5 cycles, Capacitance Change Refer to next page (*1) Dissipation Factor Initial specified value or less Leakage Current Initial specified value or less
Resistance to Soldering Heat	10 seconds reflow at 260°C, 10 seconds immersion at 260°C Capacitance Change Refer to next page (*1) Dissipation Factor Initial specified value or less Leakage Current Initial specified value or less
Surge*	After application of surge voltage in series with a 33Ω resistor at the rate of 30 seconds ON, 30 seconds OFF, for 1000 successive test cycles at 85°C, capacitors shall meet the characteristic requirements table below. Capacitance Change Refer to next page (*1) Dissipation Factor Initial specified value or less Leakage Current Initial specified value or less
Endurance*	After 2000 hours' application of rated voltage at 85°C, capacitors shall meet the characteristic requirements table below. Capacitance Change Refer to next page (*1) Dissipation Factor Initial specified value or less Leakage Current Initial specified value or less
Shear Test	After applying the pressure load of 5N for 10 ± 1 seconds horizontally to the center of capacitor side body which has no electrode and has been soldered beforehand on a substrate, there shall be found neither exfoliation nor its sign at the terminal electrode. 5N (0.51kg · f) For 10 ± 1 seconds
Terminal Strength	Keeping a capacitor surface-mounted on a substrate upside down and supporting the substrate at both of the opposite bottom points 45mm apart from the center of capacitor, the pressure strength is applied with a specified jig at the center of substrate so that the substrate may bend by 1mm as illustrated. Then, there shall be found no remarkable abnormality on the capacitor terminals. R230 45 45 1mm

* As for the surge voltage, refer to page 332 for details.

F95

Standard Ratings

Rated Volt	Rated Capacitance (μF)	Case code	Part Number	*2 Leakage Current (μA)	Dissipation Factor (%@120Hz)	ESR (Ω@100kHz)	*1 ΔC/C (%)
4V	100	P	F950G107MPAAQ2	4.0	30	1.2	±15
	100	S	F950G107MSAAQ2	4.0	14	0.8	*
	100	A	F950G107MAAAQ2	4.0	12	0.5	*
	150	P	F950G157MPAAQ2	12.0	31	1.1	±20
	150	B	F950G157MBAAQ2	6.0	14	0.4	*
	220	Q	F950G227MQAAQ2	8.8	30	1.5	±20
	220	S	F950G227MSAAQ2	8.8	30	0.8	±15
	220	A	F950G227MAAAQ2	8.8	25	0.8	±15
	220	T	F950G227MTAAQ2	8.8	25	0.6	*
	220	B	F950G227MBAAQ2	8.8	16	0.4	*
	330	A	F950G337MAAAQ2	13.2	40	0.8	±20
	330	T	F950G337MTAAQ2	13.2	40	0.8	±20
	330	B	F950G337MBAAQ2	13.2	30	0.6	±15
	470	B	F950G477MBAAQ2	18.8	40	0.4	±20
6.3V	22	R	F950J226MRAAQ2	1.4	20	2.0	±20
	33	P	F950J336MPAAQ2	2.1	14	1.1	*
	47	P	F950J476MPAAQ2	3.0	20	1.1	±15
	68	P	F950J686MPAAQ2	4.3	25	1.2	±15
	100	P	F950J107MPAAQ2	12.6	35	1.2	±20
	100	Q	F950J107MQAAQ2	6.3	30	1.1	±20
	100	S	F950J107MSAAQ2	6.3	20	0.9	±15
	100	A	F950J107MAAAQ2	6.3	14	0.5	*
	100	T	F950J107MTAAQ2	6.3	14	0.6	*
	100	B	F950J107MBAAQ2	6.3	14	0.4	*
	150	B	F950J157MBAAQ2	9.5	18	0.4	*
	220	B	F950J227MBAAQ2	13.9	30	0.4	*
	330	B	F950J337MBAAQ2	20.8	35	0.6	±20
	10V	10	R	F951A106MRAAQ2	1.0	18	3.0
10		P	F951A106MPAAQ2	1.0	8	3.0	*
15		P	F951A156MPAAQ2	1.5	10	3.0	*
22		P	F951A226MPAAQ2	2.2	14	3.0	*
22		Q	F951A226MQAAQ2	2.2	10	2.0	*
22		S	F951A226MSAAQ2	2.2	10	1.1	*
22		A	F951A226MAAAQ2	2.2	6	0.9	*
33		P	F951A336MPAAQ2	3.3	20	3.0	±15
33		Q	F951A336MQAAQ2	3.3	18	3.0	±15
33		S	F951A336MSAAQ2	3.3	10	1.1	*
33		A	F951A336MAAAQ2	3.3	10	0.8	*
47		P	F951A476MPAAQ2	4.7	30	3.0	±20
47		S	F951A476MSAAQ2	4.7	14	1.1	±15
47		A	F951A476MAAAQ2	4.7	10	0.8	*
47		T	F951A476MTAAQ2	4.7	12	0.8	*
47		B	F951A476MBAAQ2	4.7	8	0.4	*
68		B	F951A686MBAAQ2	6.8	12	0.4	*
100		A	F951A107MAAAQ2	10.0	35	1.0	±15
100		T	F951A107MTAAQ2	10.0	20	0.6	±15
100		B	F951A107MBAAQ2	10.0	14	0.4	*

Rated Volt	Rated Capacitance (μF)	Case code	Part Number	*2 Leakage Current (μA)	Dissipation Factor (%@120Hz)	ESR (Ω@100kHz)	*1 ΔC/C (%)
16V	4.7	R	F951C475MRAAQ2	0.8	12	6.0	±20
	4.7	P	F951C475MPAAQ2	0.8	10	4.0	*
	10	P	F951C106MPAAQ2	1.6	10	4.0	*
	10	Q	F951C106MQAAQ2	1.6	8	3.0	*
	10	S	F951C106MSAAQ2	1.6	8	2.0	*
	10	A	F951C106MAAAQ2	1.6	6	1.4	*
	15	S	F951C156MSAAQ2	2.4	8	2.0	*
	15	A	F951C156MAAAQ2	2.4	8	1.4	*
	22	Q	F951C226MQAAQ2	3.5	12	3.0	*
	22	S	F951C226MSAAQ2	3.5	10	2.0	±15
	22	A	F951C226MAAAQ2	3.5	8	1.4	*
	22	T	F951C226MTAAQ2	3.5	8	1.4	*
	22	B	F951C226MBAAQ2	3.5	6	0.5	*
	33	T	F951C336MTAAQ2	5.3	11	1.5	±10
33	B	F951C336MBAAQ2	5.3	8	0.5	*	
47	B	F951C476MBAAQ2	7.5	10	0.6	*	
20V	2.2	P	F951D225MPAAQ2	0.5	6	6.0	*
	4.7	S	F951D475MSAAQ2	0.9	8	4.0	*
	4.7	A	F951D475MAAAQ2	0.9	6	1.5	*
	10	S	F951D106MSAAQ2	2.0	10	4.0	±10
	10	A	F951D106MAAAQ2	2.0	8	1.5	*
	10	B	F951D106MBAAQ2	2.0	6	0.8	*
	22	B	F951D226MBAAQ2	4.4	8	0.8	*
	25V	1	R	F951E105MRAAQ2	0.5	10	10.0
2.2		R	F951E225MRAAQ2	0.6	15	15.0	±20
2.2		P	F951E225MPAAQ2	0.6	8	6.0	±15
4.7		P	F951E475MPAAQ2	1.2	10	8.0	±15
4.7		Q	F951E475MQAAQ2	1.2	10	4.0	±15
4.7		S	F951E475MSAAQ2	1.2	8	4.0	*
4.7		A	F951E475MAAAQ2	1.2	8	2.0	*
10		A	F951E106MAAAQ2	2.5	12	2.0	±15
10	B	F951E106MBAAQ2	2.5	6	0.9	*	
35V	1	P	F951V105MPAAQ2	0.5	8	10.0	±10
	1	S	F951V105MSAAQ2	0.5	6	8.0	*
	2.2	A	F951V225MAAAQ2	0.8	6	4.4	*
	4.7	B	F951V475MBAAQ2	1.7	6	1.6	*

※ In case of capacitance tolerance ±10% type, **[K]** will be put at 9th digit of type numbering system.

*1 : ΔC/C Marked **

Item	P·Q·S·A·T·B Case (%)
Damp Heat	±10
Temperature cycles	±5
Resistance soldering heat	±5
Surge	±5
Endurance	±10

*2 : Leakage Current After 1 minute's application of rated voltage, leakage current at 20°C.

SOLID TANTALUM ELECTROLYTIC CAPACITORS

F72 Low Profile
Conformal coated Chip

F75 Maximum CV
Conformal coated Chip

FRAMELESS™

Upgrade



● Compliant to the RoHS directive (2002/95/EC).

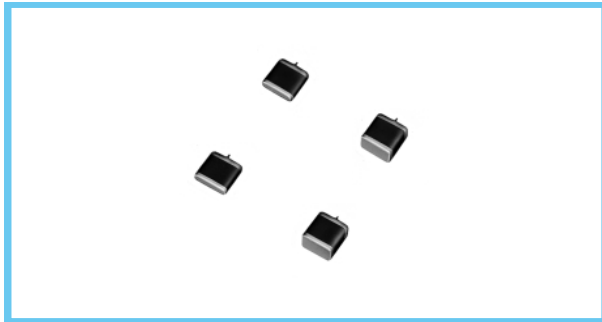

■ Applications

- Wireless modem
- Tablet PC
- e-book
- SSD
- Smart meter

F72

■ Type numbering system (Example : 10V 100μF)

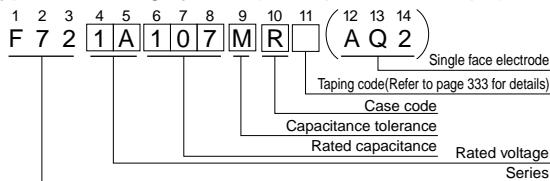

■ Drawing

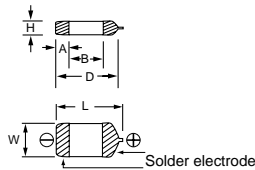

■ Dimensions

Case code	L	W	H	A	B	(D)
R	7.2 ± 0.3	6.0 ± 0.3	1.2 ± 0.3	1.3 ± 0.4	3.8 ± 0.6	(6.2)
M	7.2 ± 0.3	6.0 ± 0.3	2.0MAX.	1.3 ± 0.4	3.8 ± 0.6	(6.2)

D dimension only for reference

F75

■ Type numbering system (Example : 16V 150μF)

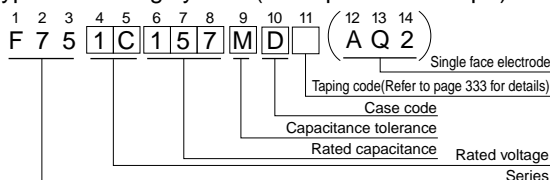

■ Drawing

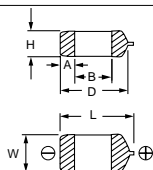

■ Standard Ratings

F72	Cap.(μF)	Code	V			
			4	6.3	10	16
	33	336	0G	0J	1A	1C
	47	476			R	R
	68	686		R	R	R
	100	107	R	R	R	
	150	157	R	R	R	
	220	227	R	R	R	
	330	337	R	R	(R)	
	470	477			M	
	680	687			M	
	1000	108		M	M	
	1500	158		M		

() The series in parentheses are being developed. Please contact to your local Nichicon sales office when these series are being designed in your application.

■ Specifications

Item	Performance Characteristics
Category	-55 to +125°C (Rated temperature : +85°C)
Temperature Range	
Capacitance Tolerance	±20%, ±10% (at 120Hz)
Dissipation Factor (120Hz)	Refer to next page
ESR (100kHz)	Refer to next page
Leakage Current	<ul style="list-style-type: none"> • After 1 minute's application of rated voltage, leakage current at 20°C is not more than 0.01CV or 0.5μA, whichever is greater. • After 1 minute's application of rated voltage, leakage current at 85°C is not more than 0.1CV or 5μA, whichever is greater. • After 1 minute's application of derated voltage, leakage current at 125°C is not more than 0.125CV or 6.3μA, whichever is greater.
Capacitance Change by Temperature	+15% Max. (at +125°C) +10% Max. (at +85°C) -10% Max. (at -55°C)
Damp Heat (Steady State)	At 40°C, 90 to 95% R.H., For 500 hours (No voltage applied) Capacitance Change Refer to * 1 Dissipation Factor Initial specified value or less Leakage Current Initial specified value or less
Temperature Cycles	At -55°C / +125°C, 30 minutes each, For 5 cycles, Capacitance Change Refer to * 1 Dissipation Factor Initial specified value or less Leakage Current Initial specified value or less
Resistance to Soldering Heat	10 seconds reflow at 260°C, 10 seconds immersion at 260°C Capacitance Change Refer to * 1 Dissipation Factor Initial specified value or less Leakage Current Initial specified value or less
Surge*	After application of surge in series with a 33Ω resistor at the rate of 30 seconds ON, 30 seconds OFF, for 1000 successive test cycles at 85°C, capacitors shall meet the characteristic requirements table below. Capacitance Change Refer to * 1 Dissipation Factor Initial specified value or less Leakage Current Initial specified value or less
Endurance*	After 2000 hours' application of rated voltage at 85°C, capacitors shall meet the characteristic requirements table below. Capacitance Change Refer to * 1 Dissipation Factor Initial specified value or less Leakage Current Initial specified value or less
Shear Test	After applying the pressure load of 5N for 10±1 seconds horizontally to the center of capacitor side body which has no electrode and has been soldered beforehand on a substrate, there shall be found neither exfoliation nor its sign at the terminal electrode.
Terminal Strength	Keeping a capacitor surface-mounted on a substrate upside down and supporting the substrate at both of the opposite bottom points 45mm apart from the center of capacitor, the pressure strength is applied with a specified jig at the center of substrate so that the substrate may bend by 1mm as illustrated. Then, there shall be found no remarkable abnormality on the capacitor terminals.

* As for the surge voltage, refer to page 332 for details.

■ Dimensions

Case code	L	W	H	A	B	(D)
U	7.1 ± 0.3	3.2 ± 0.3	2.0MAX.	1.3 ± 0.3	3.6 ± 0.6	(6.0)
C	7.1 ± 0.3	3.2 ± 0.3	2.5 ± 0.3	1.3 ± 0.3	3.6 ± 0.6	(6.0)
D	7.3 ± 0.3	4.3 ± 0.3	2.8 ± 0.3	1.3 ± 0.4	3.9 ± 0.6	(6.4)
R	7.2 ± 0.3	6.0 ± 0.3	3.5 ± 0.3	1.3 ± 0.4	3.8 ± 0.6	(6.2)

D dimension only for reference

F75

F75	Cap.(μF)	Code	V			
			4	6.3	10	16
	68	686				C
	100	107				C
	150	157				D
	220	227				R
	330	337	C	C · D	D	
	470	477	C · D	U · D	U · R	
	680	687	D	(U) · D · R		
	1000	108	D · R	(U) · R		
	1500	158	R			
	2200	228	R			

F72

Standard Ratings

Rated Volt	Rated Capacitance (μF)	Case code	Part Number	Leakage Current (μA)	Dissipation Factor (%@120Hz)	ESR (Ω@100kHz)	*1 ΔC/C (%)
4V	100	R	F720G107MRC	4.0	8	0.70	*
	150	R	F720G157MRC	6.0	10	0.70	*
	220	R	F720G227MRC	8.8	12	0.70	*
	330	R	F720G337MRC	13.2	12	0.70	*
6.3V	68	R	F720J686MRC	4.3	6	0.75	*
	100	R	F720J107MRC	6.3	8	0.70	*
	150	R	F720J157MRC	9.5	10	0.70	*
	220	R	F720J227MRC	13.9	12	0.70	*
	330	R	F720J337MRC	20.8	12	0.70	*
	1000	M	F720J108MMC	63.0	30	0.14	±15
	1500	M	F720J158MMC	95.0	45	0.14	±20
10V	47	R	F721A476MRC	4.7	6	0.80	*
	68	R	F721A686MRC	6.8	6	0.75	*
	100	R	F721A107MRC	10.0	8	0.70	*
	150	R	F721A157MRC	15.0	10	0.70	*
	220	R	F721A227MRC	22.0	12	0.70	*
	470	M	F721A477MMC	47.0	30	0.14	±15
	680	M	F721A687MMC	68.0	35	0.14	±20
	1000	M	F721A108MMC	200	45	0.14	±20
16V	33	R	F721C336MRC	5.3	6	0.90	*
	47	R	F721C476MRC	7.5	6	0.80	*
	68	R	F721C686MRC	10.9	6	0.75	*

*1 : ΔC/C Marked "**"

	F72 ALL Case (%)
Damp Heat	±10
Temperature cycles	±5
Resistance soldering heat	±5
Surge	±5
Endurance	±10

F75

Standard Ratings

Rated Volt	Rated Capacitance (μF)	Case code	Part Number	Leakage Current (μA)	Dissipation Factor (%@120Hz)	ESR (Ω@100kHz)	*1 ΔC/C (%)
4V	330	C	F750G337MCC	13.2	10	0.15	*
	470	C	F750G477MCC	18.8	14	0.12	*
	470	D	F750G477MDC	18.8	14	0.12	*
	680	D	F750G687MDC	27.2	18	0.12	*
	1000	D	F750G108MDC	40.0	24	0.12	*
	1000	R	F750G108MRC	40.0	24	0.12	*
	1500	R	F750G158MRC	60.0	30	0.12	*
	2200	R	F750G228MRC	88.0	45	0.07	*
	6.3V	220	C	F750J227MCC	13.9	10	0.20
330		C	F750J337MCC	20.8	10	0.15	*
330		D	F750J337MDC	20.8	10	0.15	*
470		U	F750J477MUC	29.6	15	0.10	*
470		D	F750J477MDC	29.6	14	0.12	*
680		D	F750J687MDC	42.8	18	0.12	*
680		R	F750J687MRC	42.8	18	0.12	*
1000		R	F750J108MRC	63.0	24	0.12	*
10V		150	C	F751A157MCC	15.0	10	0.22
	220	C	F751A227MCC	22.0	10	0.20	*
	220	D	F751A227MDC	22.0	10	0.20	*
	330	D	F751A337MDC	33.0	10	0.15	*
	470	U	F751A477MUC	94.0	30	0.15	±20
	470	R	F751A477MRC	47.0	14	0.12	*
16V	68	C	F751C686MCC	10.9	10	0.22	*
	100	C	F751C107MCC	16.0	10	0.22	*
	150	D	F751C157MDC	24.0	10	0.22	*
	220	R	F751C227MRC	35.2	10	0.20	*

*1 : ΔC/C Marked "**"

	F75 ALL Case (%)
Damp Heat	±10
Temperature cycles	±5
Resistance soldering heat	±5
Surge	±5
Endurance	±10

SOLID TANTALUM ELECTROLYTIC CAPACITORS

nichicon

F98 Resin-molded Chip,
High Capacitance Series

FRAMELESS™



Upgrade

● Compliant to the RoHS directive (2002/95/EC).

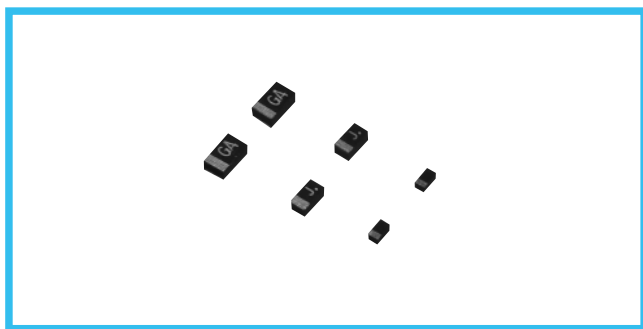

Applications

- Smartphone
- Wireless module
- Mobile phone
- Hearing aid

Type numbering system (Example : 6.3V 10μF)

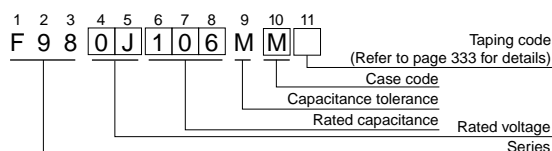

Drawing

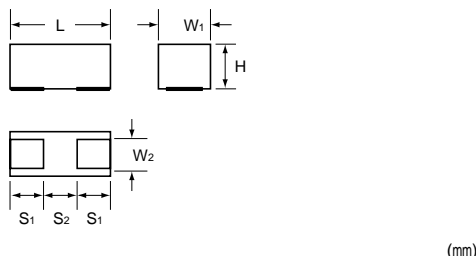

Case Code	L	W ₁	W ₂	H	S ₁	S ₂
U	1.10 ± 0.05	0.60 ± 0.05	0.35 ± 0.05	0.55 ± 0.05	0.3 ± 0.05	0.5 ± 0.05
M	1.6 ^{+0.2} _{-0.1}	0.85 ^{+0.2} _{-0.1}	0.65 ± 0.1	0.8 ± 0.1	0.5 ± 0.1	0.6 ± 0.1
S	2.0 ^{+0.2} _{-0.1}	1.25 ^{+0.2} _{-0.1}	0.9 ± 0.1	0.8 ± 0.1	0.5 ± 0.1	1.0 ± 0.1

Marking

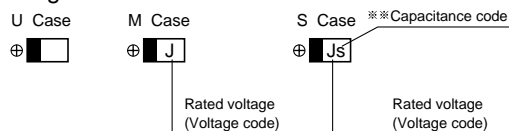

Standard Ratings

Cap. (μF)	V	Code							Capacitance code
		4	6.3	10	16	20	25		
1	105				M	M	M	—	
2.2	225			U · M	M			—	
4.7	475	U	U · M	(U) · M	M			—	
10	106	U	(U) · M	M	S			a	
22	226	M	M	(M) · S				J	
33	336	M	M	(M) · S				n	
47	476	M	M · S	S				s	
68	686	M · S						w	
100	107	M · S	S					A	
220	227	S						J	

() The series in parentheses are being developed.
Please contact to your local Nichicon sales office when these series are being designed in your application.

We can consider the type of compliance to AEC-Q200.
Please contact to your local Nichicon sales office when these series are being designed in your application.

Specifications

Item	Performance Characteristics
Category	
Temperature Range	-55 to +125°C (Rated temperature : +85°C)
Capacitance Tolerance	±20% (at 120Hz)
Dissipation Factor	Refer to the table below
ESR	Refer to the table below
Leakage Current	Refer to the table below Provided that • After 5 minute's application of rated voltage, leakage current at 85°C, 10 times or less than 20°C specified value. • After 5 minute's application of rated voltage, leakage current at 125°C, 12.5 times or less than 20°C specified value.
Damp Heat (Steady State)	At 40°C, 90 to 95% R.H., For 500hours (No voltage applied) Capacitance Change ··· Refer to the table below (* 1) Dissipation Factor ····· 150% or less of initial specified value Leakage Current ······ 200% or less of initial specified value
Temperature Cycles	At -55°C / +125°C, For 30 minutes each, 5 cycles Capacitance Change ··· Refer to the table below (* 1) Dissipation Factor ····· 150% or less than the initial specified value Leakage Current ······ Initial specified value or less
Resistance to Soldering Heat	10 seconds reflow at 260°C, 5 seconds immersion at 260°C Capacitance Change ··· Refer to the table below (* 1) Leakage Current ······ Initial specified value or less Leakage Current ······ Initial specified value or less
Surge*	After application of surge in series with a 1kΩ resistor at the rate of 30 seconds ON, 30 seconds OFF, for 1000 successive test cycles at 85°C, capacitors shall meet the characteristic requirements listed below. Capacitance Change ··· Refer to the table below (* 1) Dissipation Factor ····· 150% or less than the initial specified value Leakage Current ······ 200% or less than the initial specified value
Endurance*	After 1000 hours' application of rated voltage in series with a 3Ω resistor at 85°C, capacitors shall meet the characteristic requirements table below Capacitance Change ··· Refer to the table below (* 1) Dissipation Factor ····· 150% or less than the initial specified value Leakage Current ······ 200% or less than the initial specified value
Shear Test	After applying the pressure load of 5N for 10±1 seconds horizontally to the center of capacitor side body which has no electrode and has been soldered beforehand on a substrate, there shall be found neither exfoliation nor its sign at the terminal electrode. 5N (0.51kg · f) For 10 ± 1 seconds
Terminal Strength	Keeping a capacitor surface-mounted on a substrate upside down and supporting the substrate at both of the opposite bottom points 45mm apart from the center of capacitor, the pressure strength is applied with a specified jig at the center of the substrate so that substrate may bend by 1mm as illustrated. Then, there shall be found no remarkable abnormality on the capacitor terminals. R230 20 45 45 1mm

* As for the surge voltage, refer to page 332 for details.

Rated Volt	Rated Capacitance (μF)	Case code	Part Number	*2 Leakage Current (μA)	Dissipation Factor (% @ 120Hz)	ESR (Ω @ 100kHz)	*1 ΔC/C (%)
4V	4.7	U	F980G475MUA	0.5	20	20	±30
	10	U	F980G106MUA	0.8	25	20	±30
	22	M	F980G226MMA	0.9	15	7.5	±30
	33	M	F980G336MMA	1.3	30	4	±30
	47	M	F980G476MMA	1.9	40	8	±30
	68	M	F980G686MMA	27.2	50	10	±30
	68	S	F980G686MSA	2.7	30	4	±30
	100	M	F980G107MMA	80.0	60	10	±30
	100	S	F980G107MSA	4.0	35	4	±30
	220	S	F980G227MSA	132	80	5	±30
6.3V	4.7	U	F980J475MUA	0.6	20	20	±30
	4.7	M	F980J475MMA	0.5	20	7.5	±30
	10	M	F980J106MMA	0.6	8	6	±30
	22	M	F980J226MMA	1.4	20	6	±30
	33	M	F980J336MMA	4.2	35	8	±30
	47	M	F980J476MMA	29.6	45	10	±30
	47	S	F980J476MSA	3.0	25	6	±30
	100	S	F980J107MSA	63.0	50	8	±30
10V	2.2	U	F981A225MUA	0.5	15	15	±30
	2.2	M	F981A225MMA	0.5	6	7.5	±30
	4.7	M	F981A475MMA	0.5	6	6	±30
	10	M	F981A106MMA	1.0	20	7.5	±30
	22	S	F981A226MSA	2.2	20	4	±20
	33	S	F981A336MSA	3.3	30	6	±30
	47	S	F981A476MSA	9.4	35	5	±30
16V	1	M	F981C105MMA	0.5	6	10	±30
	2.2	M	F981C225MMA	0.5	6	10	±30
	4.7	M	F981C475MMA	0.8	12	12	±30
	10	S	F981C106MSA	1.6	18	4	±20
20V	1	M	F981D105MMA	0.5	6	10	±30
25V	1	M	F981E105MMA	0.5	8	10	±30

*2 : Leakage Current

After 5 minute's application of rated voltage, leakage current at 20°C.

CAT.8100B