

General Specifications

Motor Protection: Auto Restart/Polarity Protection
 Insulation Resistance: 10M Ohm or over with a DC500V Megger
 Dielectric Withstand Voltage: AC 700V 1st
 Allowable Ambient Temperature Range:
 -10 degree C ~ +70 degree C (Operating)
 -40 degree C ~ +70 degree C (Storage)
 (non-condensing environment)

Material

Casing: Plastic (Black) UL94V-0
 Impeller: Plastic (Black) UL94V-0
 Lead Wire: UL3385, AWG26, +Red, -Black

order part 06025SA-12Q-AL-D0 Ball Bearing Fan DC Fans



DC Fans

06025SA characteristics curve

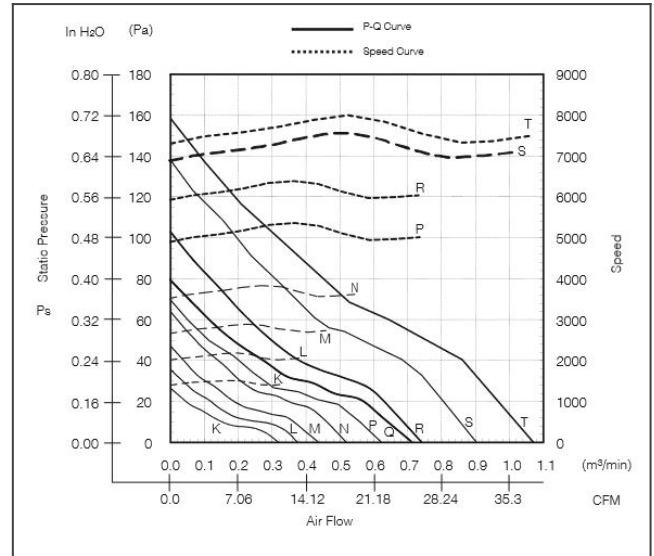

06025SA product drawing

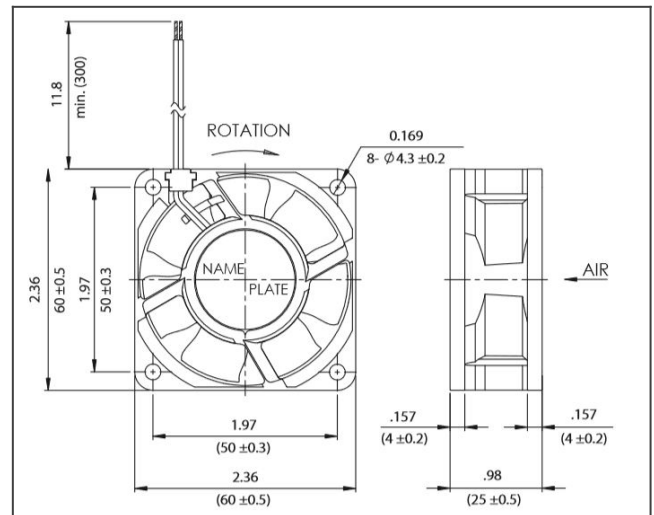

06025SA panel cut out

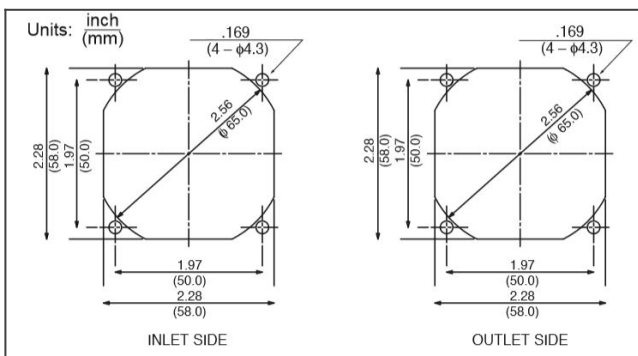

Detailed Specifications

Expected Life:	60 degree C 40,000 Hours (L10) AA/EA
DC Fan:	Ball Bearing Fan
Nominal Voltage:	12[V]
Operating Voltage Lower:	6[V]
Operating Voltage Upper:	13.2[V]
Current:	0.2[A]
Input Power:	3.4[W]
Speed:	5300[min^{-1}]
Max. Air Flow:	0.76[m^3/min]
Max. Air Flow:	26.8[CFM]
Max. Static Pressure:	80[Pa]
Max. Static Pressure:	0.32[In H ₂ O]
Noise:	35[dB]
Mass:	56[g]
Fan Size:	60[mm]
Fan Width:	25[mm]
Life Expectancy L10:	60 degree C 40,000 Hours (L10) AA/EA
Series:	06025SA

DC Fans