

54AC151 • 54ACT151 8-Input Multiplexer

General Description

The 'AC/'ACT151 is a high-speed 8-input digital multiplexer. It provides, in one package, the ability to select one line of data from up to eight sources. The 'AC/'ACT151 can be used as a universal function generator to generate any logic function of four variables. Both true and complementary outputs are provided.

Features

- I_{CC} reduced by 50%
- Outputs source/sink 24 mA
- 'ACT151 has TTL-compatible inputs
- Standard Microcircuit Drawing (SMD)
 - 'AC151: 5962-87691
 - 'ACT151: 5962-88756

Ordering Code:

Logic Symbols

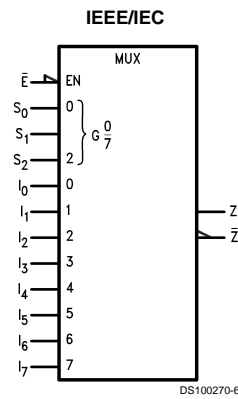
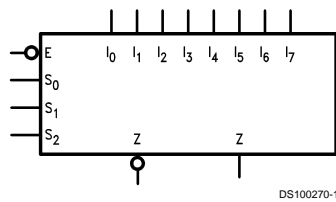

Pin Names	Description
I_0 - I_7	Data Inputs
S_0 - S_2	Select Inputs
\bar{E}	Enable Input
Z	Data Output
\bar{Z}	Inverted Data Output

Connection Diagrams

Pin Assignment
for DIP and Flatpak

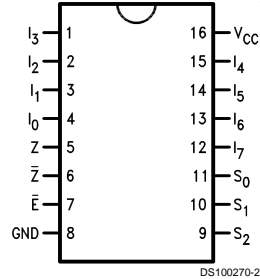

Pin Assignment
for LCC

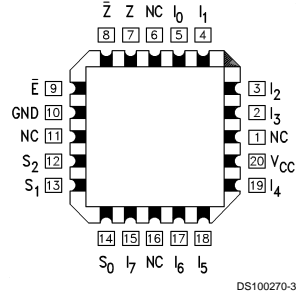

Truth Table

Inputs				Outputs	
\bar{E}	S_2	S_1	S_0	\bar{Z}	Z
H	X	X	X	H	L
L	L	L	L	\bar{I}_0	I_0
L	L	L	H	\bar{I}_1	I_1
L	L	H	L	\bar{I}_2	I_2
L	L	H	H	\bar{I}_3	I_3
L	H	L	L	\bar{I}_4	I_4
L	H	L	H	\bar{I}_5	I_5
L	H	H	L	\bar{I}_6	I_6
L	H	H	H	\bar{I}_7	I_7

H = HIGH Voltage Level
L = LOW Voltage Level
X = Immaterial

Functional Description

The 'AC/ACT151 is a logic implementation of a single pole, 8-position switch with the switch position controlled by the state of three Select inputs, S_0 , S_1 , S_2 . Both true and complementary outputs are provided. The Enable input (\bar{E}) is active LOW. When it is not activated, the complementary output is HIGH and the true output is LOW regardless of all other inputs. The logic function provided at the output is:

$$Z = \bar{E} \cdot (I_0 \cdot \bar{S}_0 \cdot \bar{S}_1 \cdot \bar{S}_2 + I_1 \cdot S_0 \cdot \bar{S}_1 \cdot \bar{S}_2 + I_2 \cdot \bar{S}_0 \cdot S_1 \cdot \bar{S}_2 + I_3 \cdot S_0 \cdot S_1 \cdot \bar{S}_2 + I_4 \cdot \bar{S}_0 \cdot \bar{S}_1 \cdot S_2 + I_5 \cdot S_0 \cdot \bar{S}_1 \cdot \bar{S}_2 + I_6 \cdot \bar{S}_0 \cdot S_1 \cdot S_2 + I_7 \cdot S_0 \cdot S_1 \cdot S_2)$$

The 'AC/ACT151 provides the ability, in one package to select from eight sources of data or control information. By proper manipulation of the inputs, the 'AC/ACT151 can provide any logic function of four variables and its complement.

Logic Diagram

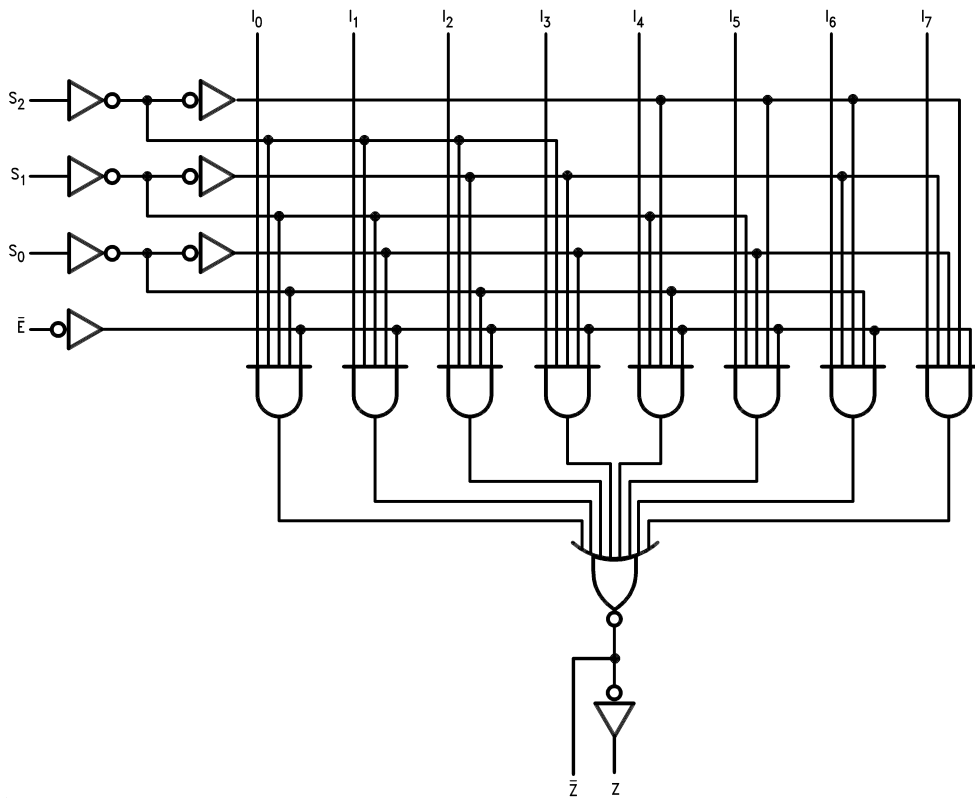

DS100270-4

Please note that this diagram is provided only for the understanding of logic operations and should not be used to estimate propagation delays.

Absolute Maximum Ratings (Note 1)

If Military/Aerospace specified devices are required, please contact the National Semiconductor Sales Office/Distributors for availability and specifications.

Supply Voltage (V_{CC})	-0.5V to +7.0V
DC Input Diode Current (I_{IK})	
$V_I = -0.5V$	-20 mA
$V_I = V_{CC} + 0.5V$	+20 mA
DC Input Voltage (V_I)	-0.5V to $V_{CC} + 0.5V$
DC Output Diode Current (I_{OK})	
$V_O = -0.5V$	-20 mA
$V_O = V_{CC} + 0.5V$	+20 mA
DC Output Voltage (V_O)	-0.5V to $V_{CC} + 0.5V$
DC Output Source or Sink Current (I_O)	±50 mA
DC V_{CC} or Ground Current per Output Pin (I_{CC} or I_{GND})	±50 mA
Storage Temperature (T_{STG})	-65°C to +150°C
Junction Temperature (T_J)	
CDIP	175°C

Recommended Operating Conditions

Supply Voltage (V_{CC})	
'AC	2.0V to 6.0V
'ACT	4.5V to 5.5V
Input Voltage (V_I)	0V to V_{CC}
Output Voltage (V_O)	0V to V_{CC}
Operating Temperature (T_A)	
54AC/ACT	-55°C to +125°C
Minimum Input Edge Rate ($\Delta V/\Delta t$)	
'AC Devices	
V_{IN} from 30% to 70% of V_{CC}	
V_{CC} @ 3.3V, 4.5V, 5.5V	125 mV/ns
Minimum Input Edge Rate ($\Delta V/\Delta t$)	
'ACT Devices	
V_{IN} from 0.8V to 2.0V	
V_{CC} @ 4.5V, 5.5V	125 mV/ns

Note 1: Absolute maximum ratings are those values beyond which damage to the device may occur. The databook specifications should be met, without exception, to ensure that the system design is reliable over its power supply, temperature, and output/input loading variables. National does not recommend operation of FACT® circuits outside databook specifications.

DC Characteristics for 'AC Family Devices

Symbol	Parameter	V_{CC} (V)	54AC		Units	Conditions
			$T_A = -55^\circ\text{C to } +125^\circ\text{C}$			
			Guaranteed Limits			
V_{IH}	Minimum High Level Input Voltage	3.0	2.1	V	$V_{OUT} = 0.1V$ or $V_{CC} - 0.1V$	
		4.5	3.15			
		5.5	3.85			
V_{IL}	Maximum Low Level Input Voltage	3.0	0.9	V	$V_{OUT} = 0.1V$ or $V_{CC} - 0.1V$	
		4.5	1.35			
		5.5	1.65			
V_{OH}	Minimum High Level Output Voltage	3.0	2.9	V	$I_{OUT} = -50 \mu A$	
		4.5	4.4			
		5.5	5.4			
V_{OL}	Maximum Low Level Output Voltage	3.0	2.4	V	(Note 2) $V_{IN} = V_{IL}$ or V_{IH} $I_{OH} = -12 \text{ mA}$ $I_{OH} = -24 \text{ mA}$ $I_{OH} = -24 \text{ mA}$	
		4.5	3.7			
		5.5	4.7			
V_{OL}	Maximum Low Level Output Voltage	3.0	0.1	V	$I_{OUT} = 50 \mu A$	
		4.5	0.1			
		5.5	0.1			
V_{OL}	Maximum Low Level Output Voltage	3.0	0.50	V	(Note 2) $V_{IN} = V_{IL}$ or V_{IH} $I_{OL} = 12 \text{ mA}$ $I_{OL} = 24 \text{ mA}$ $I_{OL} = 24 \text{ mA}$	
		4.5	0.50			
		5.5	0.50			
I_{IN}	Maximum Input Leakage Current	5.5	±1.0	μA	$V_I = V_{CC}, GND$	
I_{OLD}	Minimum Dynamic	5.5	50	mA	$V_{OLD} = 1.65V \text{ Max}$	
I_{OHD}	Output Current (Note 3)	5.5	-50	mA	$V_{OHD} = 3.85V \text{ Min}$	

DC Characteristics for 'AC Family Devices (Continued)

Symbol	Parameter	V _{CC} (V)	54AC		Units	Conditions
			T _A = -55°C to +125°C			
			Guaranteed Limits			
I _{CC}	Maximum Quiescent Supply Current	5.5	80.0		μA	V _{IN} = V _{CC} or GND

Note 2: All outputs loaded; thresholds on input associated with output under test.

Note 3: Maximum test duration 2.0 ms, one output loaded at a time.

Note 4: I_{IN} and I_{CC} @ 3.0V are guaranteed to be less than or equal to the respective limit @ 5.5V V_{CC}.

I_{CC} for 54AC @ 25°C is identical to 74AC @ 25°C

DC Characteristics for 'ACT Family Devices

Symbol	Parameter	V _{CC} (V)	54ACT		Units	Conditions
			T _A = -55°C to +125°C			
			Guaranteed Limits			
V _{IH}	Minimum High Level Input Voltage	4.5	2.0		V	V _{OUT} = 0.1V or V _{CC} - 0.1V
		5.5	2.0			
V _{IL}	Maximum Low Level Input Voltage	4.5	0.8		V	V _{OUT} = 0.1V or V _{CC} - 0.1V
		5.5	0.8			
V _{OH}	Minimum High Level Output Voltage	4.5	4.4		V	I _{OUT} = -50 μA
		5.5	5.4			
		4.5	3.70		V	(Note 5) V _{IN} = V _{IL} or V _{IH} I _{OH} = -24 mA I _{OH} = -24 mA
		5.5	4.70			
V _{OL}	Maximum Low Level Output Voltage	4.5	0.1		V	I _{OUT} = 50 μA
		5.5	0.1			
		4.5	0.50		V	(Note 5) V _{IN} = V _{IL} or V _{IH} I _{OL} = 24 mA I _{OL} = 24 mA
		5.5	0.50			
I _{IN}	Maximum Input Leakage Current	5.5	±1.0		μA	V _I = V _{CC} , GND
I _{CCT}	Maximum I _{CC} /Input	5.5	1.6		mA	V _I = V _{CC} - 2.1V
I _{OLD}	Minimum Dynamic	5.5	50		mA	V _{OLD} = 1.65V Max
I _{OHD}	Output Current (Note 6)	5.5	-50		mA	V _{OHD} = 3.85V Min
I _{CC}	Maximum Quiescent Supply Current	5.5	80.0		μA	V _{IN} = V _{CC} or GND

Note 5: All outputs loaded; thresholds on input associated with output under test.

Note 6: Maximum test duration 2.0 ms, one output loaded at a time.

Note 7: I_{CC} for 54ACT @ 25°C is identical to 74ACT @ 25°C.

AC Electrical Characteristics

Symbol	Parameter	V _{CC} (V) (Note 8)	54AC		Units	Fig. No.
			T _A = -55°C to +125°C			
			C _L = 50 pF			
		Min	Max			
t _{PLH}	Propagation Delay S _n to Z or \bar{Z}	3.3	1.0	22.0	ns	
		5.0	1.0	15.5		

AC Electrical Characteristics (Continued)

Symbol	Parameter	V _{CC} (V) (Note 8)	54AC		Units	Fig. No.
			T _A = -55°C to +125°C C _L = 50 pF			
			Min	Max		
t _{PHL}	Propagation Delay S _n to Z or \bar{Z}	3.3	1.0	22.0	ns	
		5.0	1.0	15.5		
t _{PLH}	Propagation Delay \bar{E} to Z or \bar{Z}	3.3	1.0	15.5	ns	
		5.0	1.0	12.0		
t _{PHL}	Propagation Delay \bar{E} to Z or \bar{Z}	3.3	1.0	15.5	ns	
		5.0	1.0	12.0		
t _{PLH}	Propagation Delay I _n to Z or \bar{Z}	3.3	1.0	16.0	ns	
		5.0	1.0	12.0		
t _{PHL}	Propagation Delay I _n to Z or \bar{Z}	3.3	1.0	18.0	ns	
		5.0	1.0	13.0		

Note 8: Voltage Range 3.3 is 3.3V ±0.3V
Voltage Range 5.0 is 5.0V ±0.5V

AC Electrical Characteristics

Symbol	Parameter	V _{CC} (V) (Note 9)	54ACT		Units	Fig. No.
			T _A = -55°C to +125°C C _L = 50 pF			
			Min	Max		
t _{PLH}	Propagation Delay S _n to Z	5.0	1.0	19.5	ns	
t _{PHL}	Propagation Delay S _n to Z	5.0	1.0	20.0	ns	
t _{PLH}	Propagation Delay S _n to \bar{Z}	5.0	1.0	19.5	ns	
t _{PHL}	Propagation Delay S _n to \bar{Z}	5.0	1.0	20.0	ns	
t _{PLH}	Propagation Delay \bar{E} to Z	5.0	1.0	12.0	ns	
t _{PHL}	Propagation Delay \bar{E} to Z	5.0	1.0	12.5	ns	
t _{PLH}	Propagation Delay \bar{E} to \bar{Z}	5.0	1.0	12.0	ns	
t _{PHL}	Propagation Delay \bar{E} to \bar{Z}	5.0	1.0	12.5	ns	
t _{PLH}	Propagation Delay I _n to Z	5.0	1.0	15.0	ns	
t _{PHL}	Propagation Delay I _n to Z	5.0	1.0	16.0	ns	
t _{PLH}	Propagation Delay I _n to \bar{Z}	5.0	1.0	15.0	ns	
t _{PHL}	Propagation Delay I _n to \bar{Z}	5.0	1.0	16.0	ns	

Note 9: Voltage Range 5.0 is 5.0V ±0.5V

Capacitance

Symbol	Parameter	Typ	Units	Conditions
C_{IN}	Input Capacitance	4.5	pF	$V_{CC} = OPEN$
C_{PD}	Power Dissipation Capacitance	70.0	pF	$V_{CC} = 5.0V$



Physical Dimensions inches (millimeters) unless otherwise noted

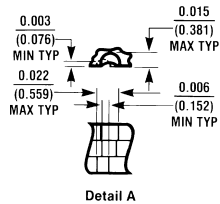
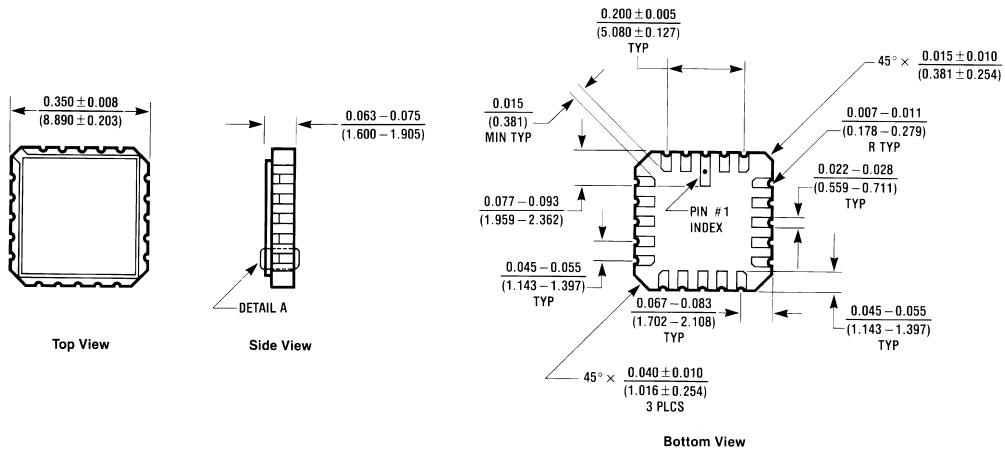

20 Terminal Ceramic Leadless Chip Carrier (L)
 NS Package Number E20A

E20A (REV D)

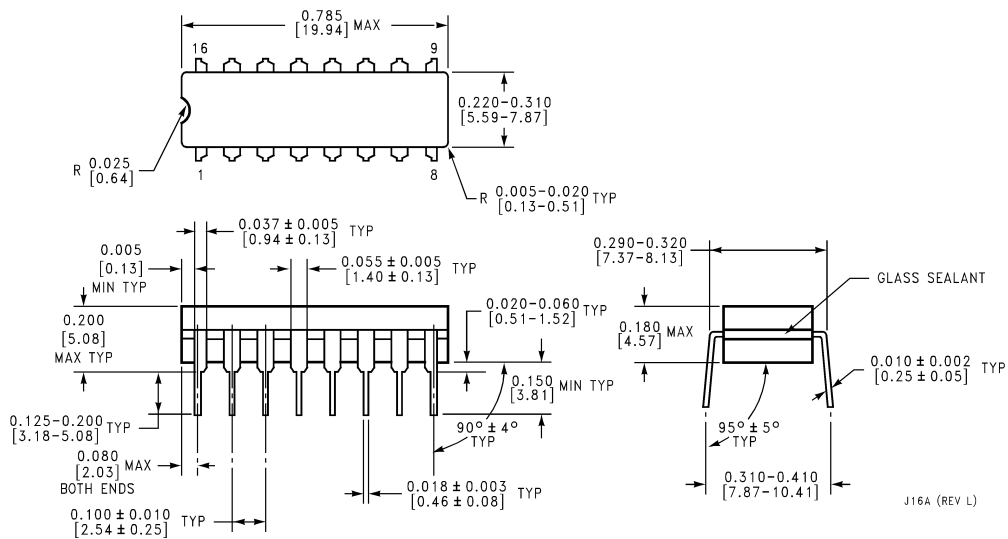

16 Lead Ceramic Dual-In-Line Package (D)
 NS Package Number J16A

J16A (REV L)

Physical Dimensions inches (millimeters) unless otherwise noted (Continued)

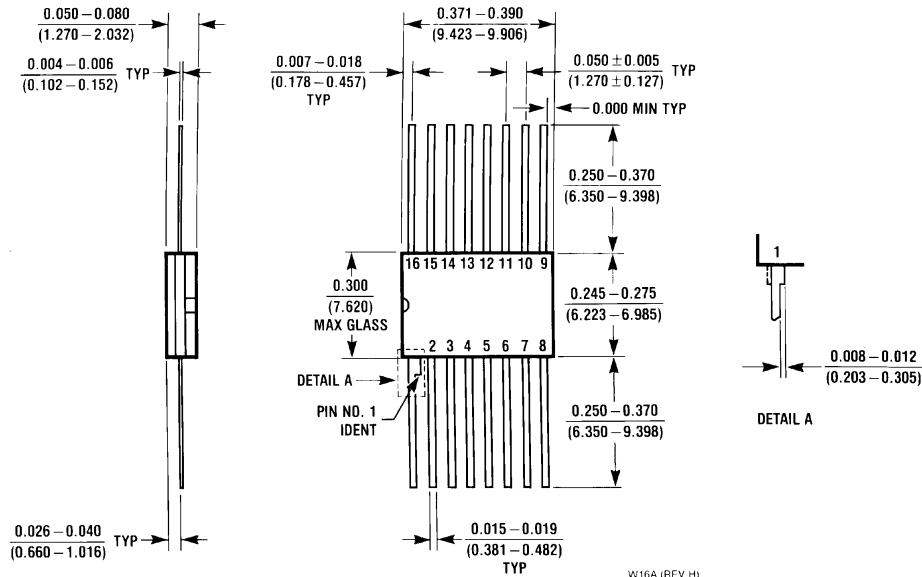

**16 Lead Ceramic Flatpak (F)
NS Package Number W16A**

LIFE SUPPORT POLICY

NATIONAL'S PRODUCTS ARE NOT AUTHORIZED FOR USE AS CRITICAL COMPONENTS IN LIFE SUPPORT DEVICES OR SYSTEMS WITHOUT THE EXPRESS WRITTEN APPROVAL OF THE PRESIDENT OF NATIONAL SEMICONDUCTOR CORPORATION. As used herein:

1. Life support devices or systems are devices or systems which, (a) are intended for surgical implant into the body, or (b) support or sustain life, and whose failure to perform when properly used in accordance with instructions for use provided in the labeling, can be reasonably expected to result in a significant injury to the user.
2. A critical component in any component of a life support device or system whose failure to perform can be reasonably expected to cause the failure of the life support device or system, or to affect its safety or effectiveness.





National Semiconductor Corporation
Americas
Tel: 1-800-272-9959
Fax: 1-800-737-7018
Email: support@nsc.com

National Semiconductor Europe
Fax: +49 (0) 1 80-530 85 86
Email: europe.support@nsc.com
Deutsch Tel: +49 (0) 1 80-530 85 85
English Tel: +49 (0) 1 80-532 78 32
Français Tel: +49 (0) 1 80-532 93 58
Italiano Tel: +49 (0) 1 80-534 16 80

National Semiconductor Asia Pacific Customer Response Group
Tel: 65-2544466
Fax: 65-2504466
Email: sea.support@nsc.com

National Semiconductor Japan Ltd.
Tel: 81-3-5620-6175
Fax: 81-3-5620-6179

www.national.com

 National Semiconductor Corporation Home	Design · Purchasing · Quality · Company · Jobs
	
Products > Military/Aerospace > Logic > FACT ACT > 54ACT151	

 [Product Folder](#)

54ACT151 8-Input Multiplexer

Contents

- [General Description](#)
- [Features](#)
- [Datasheet](#)
- [Package Availability, Models, Samples & Pricing](#)
- [Application Notes](#)



General Description

The 'AC/'ACT151 is a high-speed 8-input digital multiplexer. It provides, in one package, the ability to select one line of data from up to eight sources. The 'AC/'ACT151 can be used as a universal function generator to generate any logic function of four variables. Both true and complementary outputs are provided.

Features

- I_{CC} reduced by 50%
 - Outputs source/sink 24 mA
 - 'ACT151 has TTL-compatible inputs
 - Standard Microcircuit Drawing (SMD) - 'AC151: 5962-87691 - 'ACT151: 5962-88756
-

Datasheet

Title	Size (in Kbytes)	Date	 View Online	 Download	 Receive via Email
54AC151 54ACT151 8-Input Multiplexer	156 Kbytes	14-Aug-98	View Online	Download	Receive via Email



Please use [Adobe Acrobat](#) to view PDF file(s).
If you have trouble printing, see [Printing Problems](#).

Package Availability, Models, Samples & Pricing

Part Number	Package		Status	Models		Samples & Electronic Orders	Budgetary
	Type	# pins		SPICE	IBIS		Quantity
5962-8875601M2A	LCC	20	Full production	N/A	N/A	.	50+
5962-8875601MEA	Cerdip	16	Full production	N/A	N/A	 Order	50+
5962-8875601MFA	Cerpack	16	Full production	N/A	N/A	.	50+
5962R8875601B2A	LCC	20	Full production	N/A	N/A	.	50+
5962R8875601BEA	Cerdip	16	Full production	N/A	N/A	.	50+
5962R8875601BFA	Cerpack	16	Full production	N/A	N/A	.	50+

5962R8875601S2A	LCC	20	Full production	N/A	N/A	.	50+
5962R8875601SEA	Cerdip	16	Full production	N/A	N/A	.	50+
5962R8875601SFA	Cerpack	16	Full production	N/A	N/A	.	50+

Application Notes

Title	Size (in Kbytes)	Date	 View Online	 Download	 Receive via Email
AN-925: Radiation Design Test Data for Advanced CMOS Product	194 Kbytes	5-Aug-95	View Online	Download	Receive via Email

Please use [Adobe Acrobat](#) to view PDF file(s).
If you have trouble printing, see [Printing Problems](#).

[Information as of 7-Mar-2001]

Quick Search

[Parametric Search](#)

[System Diagrams](#)

[Product Tree](#)

[Home](#)

[About Languages](#) . [Website Guide](#) . [About "Cookies"](#) . National is [QS 9000 Certified](#)
[Site Terms & Conditions of Use](#) . Copyright 2001 © National Semiconductor Corporation
[Privacy/Security Statement](#) . [Preferences](#) . [Feedback](#)