

54AC251 • 54ACT251 8-Input Multiplexer with TRI-STATE® Output

General Description

The 'AC/'ACT251 is a high-speed 8-input digital multiplexer. It provides, in one package, the ability to select one bit of data from up to eight sources. It can be used as universal function generator to generate any logic function of four variables. Both true and complementary outputs are provided.

Features

- I_{CC} reduced by 50%

- Multifunctional capability
- On-chip select logic decoding
- Inverting and noninverting TRI-STATE outputs
- Outputs source/sink 24 mA
- 'ACT251 has TTL-compatible inputs
- Standard Military Drawing (SMD)
 - 'AC251: 5962-87692
 - 'ACT251: 5962-89599

Logic Symbols

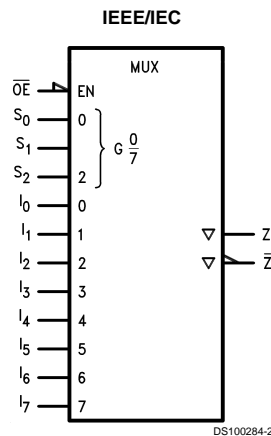
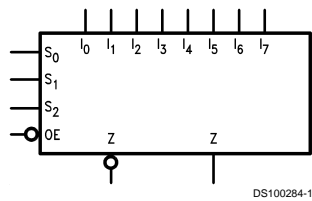

Pin Names	Description
S_0 – S_2	Select Inputs
\overline{OE}	TRI-STATE Output Enable Input
I_0 – I_7	Multiplexer Inputs
Z	TRI-STATE Multiplexer Output
\bar{Z}	Complementary TRI-STATE Multiplexer Output

TRI-STATE® is a registered trademark of National Semiconductor Corporation.
FACT® is a registered trademark of Fairchild Semiconductor Corporation.

Connection Diagrams

Pin Assignment
for DIP and Flatpak

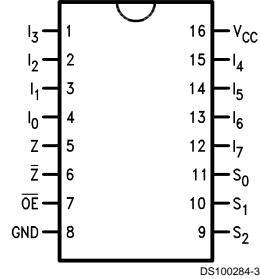

Pin Assignment
for LCC

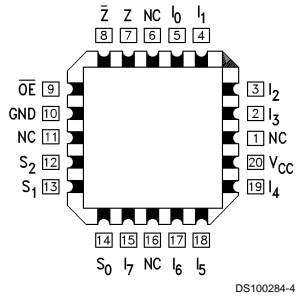

Functional Description

This device is a logical implementation of a single-pole, 8-position switch with the switch position controlled by the state of three Select inputs, S_0 , S_1 , S_2 . Both true and complementary outputs are provided. The Output Enable input (\overline{OE}) is active LOW. When it is activated, the logic function provided at the output is:

$$Z = \overline{OE} \cdot (I_0 \cdot \overline{S_0} \cdot \overline{S_1} \cdot \overline{S_2} + I_1 \cdot S_0 \cdot \overline{S_1} \cdot \overline{S_2} + I_2 \cdot \overline{S_0} \cdot S_1 \cdot \overline{S_2} + I_3 \cdot S_0 \cdot S_1 \cdot \overline{S_2} + I_4 \cdot \overline{S_0} \cdot \overline{S_1} \cdot S_2 + I_5 \cdot S_0 \cdot \overline{S_1} \cdot S_2 + I_6 \cdot \overline{S_0} \cdot S_1 \cdot S_2 + I_7 \cdot S_0 \cdot S_1 \cdot S_2)$$

When the Output Enable is HIGH, both outputs are in the high impedance (High Z) state. This feature allows multiplexer expansion by tying the outputs of up to 128 devices together. When the outputs of the TRI-STATE devices are tied together, all but one device must be in the high impedance state to avoid high currents that would exceed the maximum ratings. The Output Enable signals should be designed to ensure there is no overlap in the active-LOW portion of the enable voltages.

Truth Table

\overline{OE}	Inputs			Outputs	
	S_2	S_1	S_0	\overline{Z}	Z
H	X	X	X	Z	Z
L	L	L	L	$\overline{I_0}$	I_0
L	L	L	H	$\overline{I_1}$	I_1
L	L	H	L	$\overline{I_2}$	I_2
L	L	H	H	$\overline{I_3}$	I_3
L	H	L	L	$\overline{I_4}$	I_4
L	H	L	H	$\overline{I_5}$	I_5
L	H	H	L	$\overline{I_6}$	I_6
L	H	H	H	$\overline{I_7}$	I_7

H = HIGH Voltage Level
L = LOW Voltage Level
X = Immaterial
Z = High Impedance

Logic Diagram

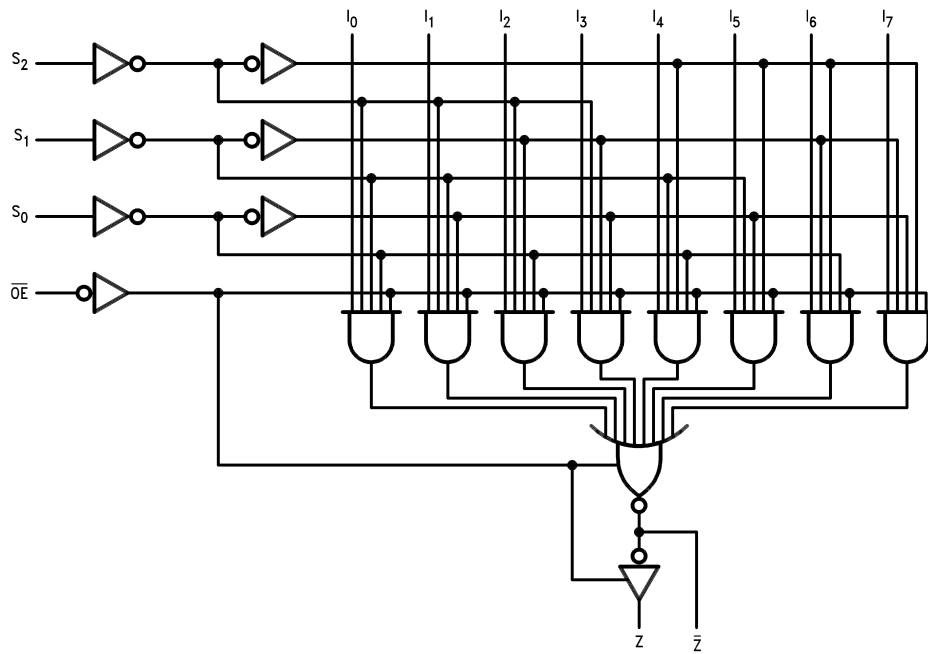

DS100284-5

Please note that this diagram is provided only for the understanding of logic operations and should not be used to estimate propagation delays.

Absolute Maximum Ratings (Note 1)

If Military/Aerospace specified devices are required, please contact the National Semiconductor Sales Office/Distributors for availability and specifications.

Supply Voltage (V_{CC})	-0.5V to +7.0V
DC Input Diode Current (I_{IK})	
$V_I = -0.5V$	-20 mA
$V_I = V_{CC} + 0.5V$	+20 mA
DC Input Voltage (V_I)	-0.5V to $V_{CC} + 0.5V$
DC Output Diode Current (I_{OK})	
$V_O = -0.5V$	-20 mA
$V_O = V_{CC} + 0.5V$	+20 mA
DC Output Voltage (V_O)	-0.5V to $V_{CC} + 0.5V$
DC Output Source or Sink Current (I_O)	±50 mA
DC V_{CC} or Ground Current per Output Pin (I_{CC} or I_{GND})	±50 mA
Storage Temperature (T_{STG})	-65°C to +150°C
Junction Temperature (T_J)	
CDIP	175°C

Recommended Operating Conditions

Supply Voltage (V_{CC})	
'AC	2.0V to 6.0V
'ACT	4.5V to 5.5V
Input Voltage (V_I)	0V to V_{CC}
Output Voltage (V_O)	0V to V_{CC}
Operating Temperature (T_A)	
54AC/ACT	-55°C to +125°C
Minimum Input Edge Rate ($\Delta V/\Delta t$)	
'AC Devices	
V_{IN} from 30% to 70% of V_{CC}	
V_{CC} @ 3.3V, 4.5V, 5.5V	125 mV/ns
'ACT Devices	
V_{IN} from 0.8V to 2.0V	
V_{CC} @ 4.5V, 5.5V	125 mV/ns

Note 1: Absolute maximum ratings are those values beyond which damage to the device may occur. The databook specifications should be met, without exception, to ensure that the system design is reliable over its power supply, temperature, and output/input loading variables. National does not recommend operation of FACT® circuits outside databook specifications.

Note 2: All outputs loaded; thresholds on input associated with output under test.

DC Characteristics for 'AC Family Devices

Symbol	Parameter	V_{CC} (V)	54AC		Units	Conditions
			$T_A = -55^\circ\text{C to } +125^\circ\text{C}$			
			Guaranteed Limits			
V_{IH}	Minimum High Level Input Voltage	3.0	2.1	V	$V_{OUT} = 0.1V$ or $V_{CC} - 0.1V$	
		4.5	3.15			
		5.5	3.85			
V_{IL}	Maximum Low Level Input Voltage	3.0	0.9	V	$V_{OUT} = 0.1V$ or $V_{CC} - 0.1V$	
		4.5	1.35			
		5.5	1.65			
V_{OH}	Minimum High Level Output Voltage	3.0	2.9	V	$I_{OUT} = -50 \mu\text{A}$	
		4.5	4.4			
		5.5	5.4			
V_{OL}	Maximum Low Level Output Voltage	3.0	2.4	V	(Note 2) $V_{IN} = V_{IL}$ or V_{IH} $I_{OH} = -12 \text{ mA}$ $I_{OH} = -24 \text{ mA}$ $I_{OH} = -24 \text{ mA}$	
		4.5	3.7			
		5.5	4.7			
V_{OL}	Maximum Low Level Output Voltage	3.0	0.1	V	$I_{OUT} = 50 \mu\text{A}$	
		4.5	0.1			
		5.5	0.1			
V_{OL}	Maximum Low Level Output Voltage	3.0	0.50	V	(Note 2) $V_{IN} = V_{IL}$ or V_{IH} $I_{OL} = 12 \text{ mA}$ $I_{OL} = 24 \text{ mA}$ $I_{OL} = 24 \text{ mA}$	
		4.5	0.50			
		5.5	0.50			
I_{IN}	Maximum Input Leakage Current	5.5	±1.0	µA	$V_I = V_{CC}, \text{ GND}$	

DC Characteristics for 'AC Family Devices (Continued)

Symbol	Parameter	V _{CC} (V)	54AC		Units	Conditions
			T _A = -55°C to +125°C			
			Guaranteed Limits			
I _{OZ}	Maximum TRI-STATE Current	5.5	±5.0		μA	V _I (OE) = V _{IL} , V _{IH} V _I = V _{CC} , V _{GND} V _O = V _{CC} , GND
I _{OLD}	Minimum Dynamic	5.5	50		mA	V _{OLD} = 1.65V Max
I _{OHD}	Output Current (Note 3)	5.5	-50		mA	V _{OHD} = 3.85V Min
I _{CC}	Maximum Quiescent Supply Current	5.5	80.0		μA	V _{IN} = V _{CC} or GND

Note 3: Maximum test duration 2.0 ms, one output loaded at a time.

Note 4: I_{IN} and I_{CC} @ 3.0V are guaranteed to be less than or equal to the respective limit @ 5.5V V_{CC}.

I_{CC} for 54AC @ 25°C is identical to 74AC @ 25°C.

DC Characteristics for 'ACT Family Devices

Symbol	Parameter	V _{CC} (V)	54ACT		Units	Conditions
			T _A = -55°C to +125°C			
			Guaranteed Limits			
V _{IH}	Minimum High Level Input Voltage	4.5	2.0		V	V _{OUT} = 0.1V or V _{CC} - 0.1V
		5.5	2.0			
V _{IL}	Maximum Low Level Input Voltage	4.5	0.8		V	V _{OUT} = 0.1V or V _{CC} - 0.1V
		5.5	0.8			
V _{OH}	Minimum High Level Output Voltage	4.5	4.4		V	I _{OUT} = -50 μA
		5.5	5.4			
		4.5	3.70		V	(Note 5) V _{IN} = V _{IL} or V _{IH} I _{OH} = -24 mA I _{OH} = -24 mA
		5.5	4.70			
V _{OL}	Maximum Low Level Output Voltage	4.5	0.1		V	I _{OUT} = 50 μA
		5.5	0.1			
		4.5	0.50		V	(Note 5) V _{IN} = V _{IL} or V _{IH} I _{OL} = 24 mA I _{OL} = 24 mA
	5.5	0.50				
I _{IN}	Maximum Input Leakage Current	5.5	±1.0		μA	V _I = V _{CC} , GND
I _{OZ}	Maximum TRI-STATE Current	5.5	±5.0		μA	V _I = V _{IL} , V _{IH} V _O = V _{CC} , GND
I _{CCT}	Maximum I _{CC} /Input	5.5	1.6		mA	V _I = V _{CC} - 2.1V
I _{OLD}	Minimum Dynamic	5.5	50		mA	V _{OLD} = 1.65V Max
I _{OHD}	Output Current (Note 6)	5.5	-50		mA	V _{OHD} = 3.85V Min
I _{CC}	Maximum Quiescent Supply Current	5.5	80.0		μA	V _{IN} = V _{CC} or GND

Note 5: All outputs loaded; thresholds on input associated with output under test.

Note 6: Maximum test duration 2.0 ms, one output loaded at a time.

Note 7: I_{CC} for 54ACT @ 25°C is identical to 74ACT @ 25°C.

AC Electrical Characteristics

Symbol	Parameter	V _{CC} (V) (Note 8)	54AC		Units
			T _A = -55°C to +125°C C _L = 50 pF		
			Min	Max	
t _{PLH}	Propagation Delay S _n to Z or \bar{Z}	3.3	1.0	21.0	ns
		5.0	1.0	15.5	
t _{PHL}	Propagation Delay S _n to Z or \bar{Z}	3.3	1.0	21.0	ns
		5.0	1.0	15.5	
t _{PLH}	Propagation Delay I _n to Z or \bar{Z}	3.3	1.0	17.0	ns
		5.0	1.0	12.0	
t _{PHL}	Propagation Delay I _n to Z or \bar{Z}	3.3	1.0	16.5	ns
		5.0	1.0	12.0	
t _{PZH}	Output Enable Time \overline{OE} to Z or \bar{Z}	3.3	1.0	13.0	ns
		5.0	1.0	10.0	
t _{PZL}	Output Enable Time \overline{OE} to Z or \bar{Z}	3.3	1.0	13.0	ns
		5.0	1.0	10.0	
t _{PHZ}	Output Disable Time \overline{OE} to Z or \bar{Z}	3.3	3.5	14.0	ns
		5.0	2.5	11.0	
t _{PLZ}	Output Disable Time \overline{OE} to Z or \bar{Z}	3.3	4.0	13.0	ns
		5.0	3.0	10.0	

Note 8: Voltage Range 3.3 is 3.3V ±0.3V
Voltage Range 5.0 is 5.0V ±0.5V

AC Electrical Characteristics

Symbol	Parameter	V _{CC} (V) (Note 9)	54ACT		Units
			T _A = -55°C to +125°C C _L = 50 pF		
			Min	Max	
t _{PLH}	Propagation Delay S _n to Z or \bar{Z}	5.0	1.0	18.0	ns
		5.0	1.0	18.0	
t _{PHL}	Propagation Delay S _n to Z or \bar{Z}	5.0	1.0	13.5	ns
		5.0	1.0	13.5	
t _{PLH}	Propagation Delay I _n to Z or \bar{Z}	5.0	1.0	13.5	ns
		5.0	1.0	13.5	
t _{PZH}	Output Enable Time \overline{OE} to Z or \bar{Z}	5.0	1.0	10.0	ns
		5.0	1.0	9.5	
t _{PZL}	Output Enable Time \overline{OE} to Z or \bar{Z}	5.0	1.0	12.5	ns
		5.0	1.0	8.5	
t _{PHZ}	Output Disable Time \overline{OE} to Z or \bar{Z}	5.0	1.0	12.5	ns
		5.0	1.0	8.5	
t _{PLZ}	Output Disable Time \overline{OE} to Z or \bar{Z}	5.0	1.0	8.5	ns
		5.0	1.0	8.5	

Note 9: Voltage Range 5.0 is 5.0V ±0.5V

Capacitance

Symbol	Parameter	Typ	Units	Conditions
C _{IN}	Input Capacitance	4.5	pF	V _{CC} = OPEN
C _{PD}	Power Dissipation Capacitance	70.0	pF	V _{CC} = 5.0V

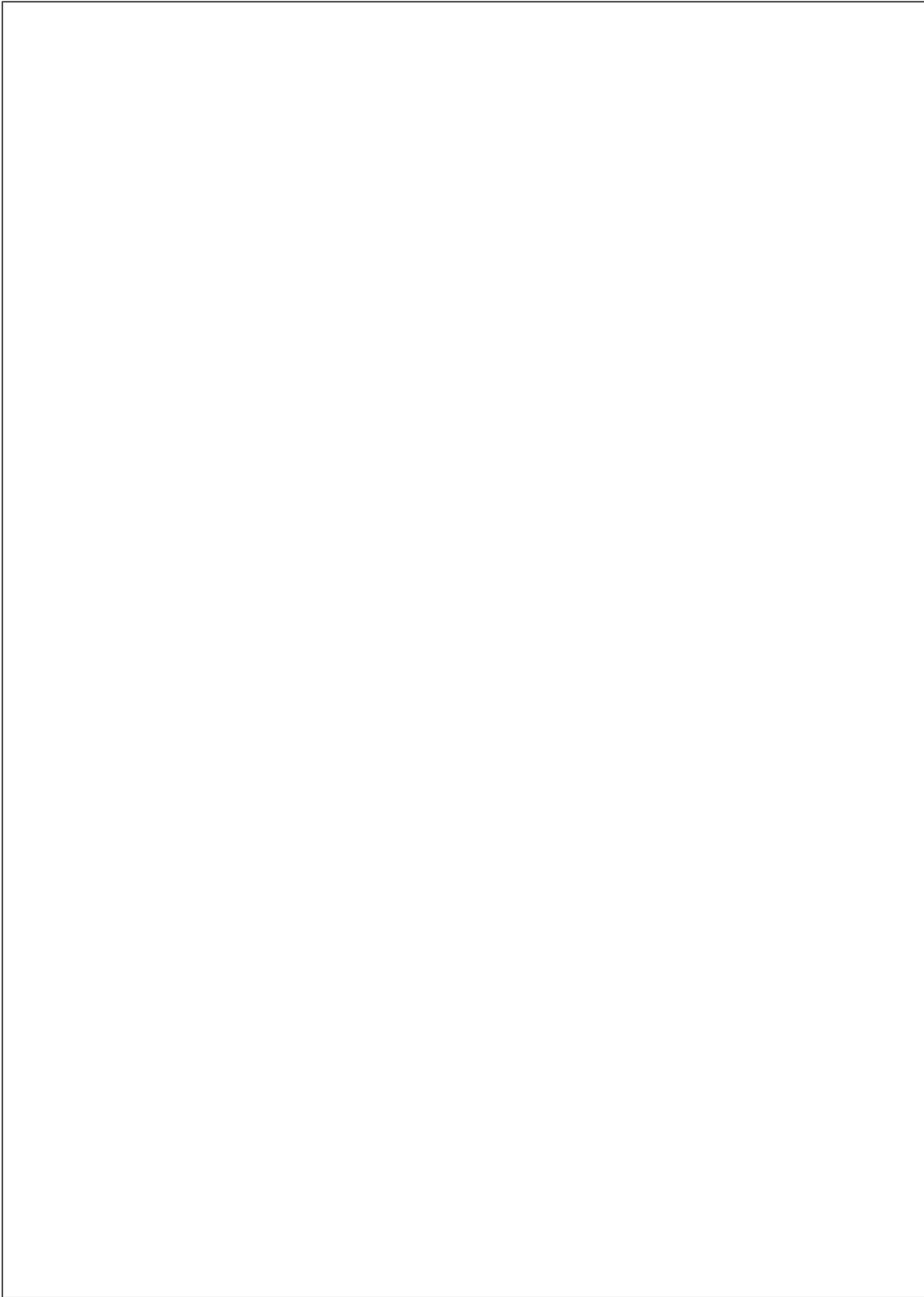

Physical Dimensions inches (millimeters) unless otherwise noted

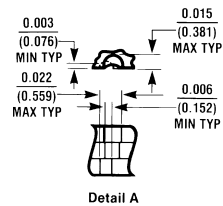
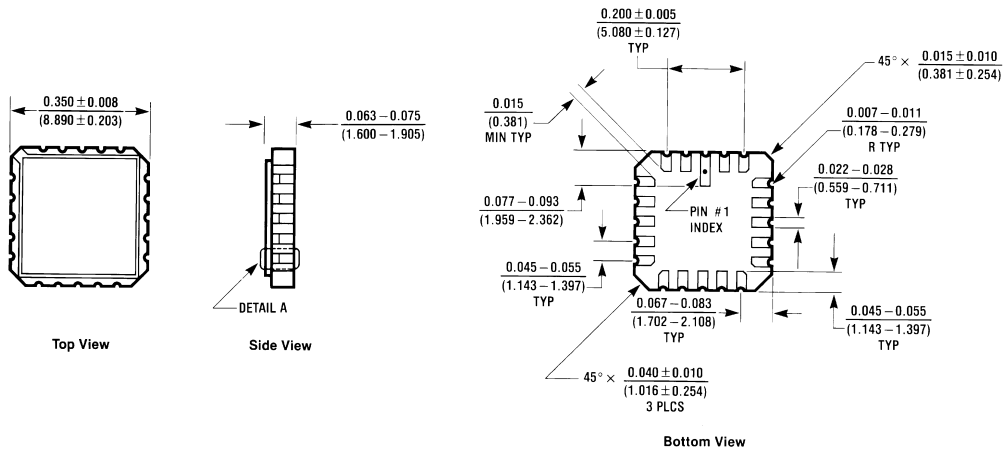

20 Terminal Ceramic Leadless Chip Carrier (L)
 NS Package Number E20A

E20A (REV D)

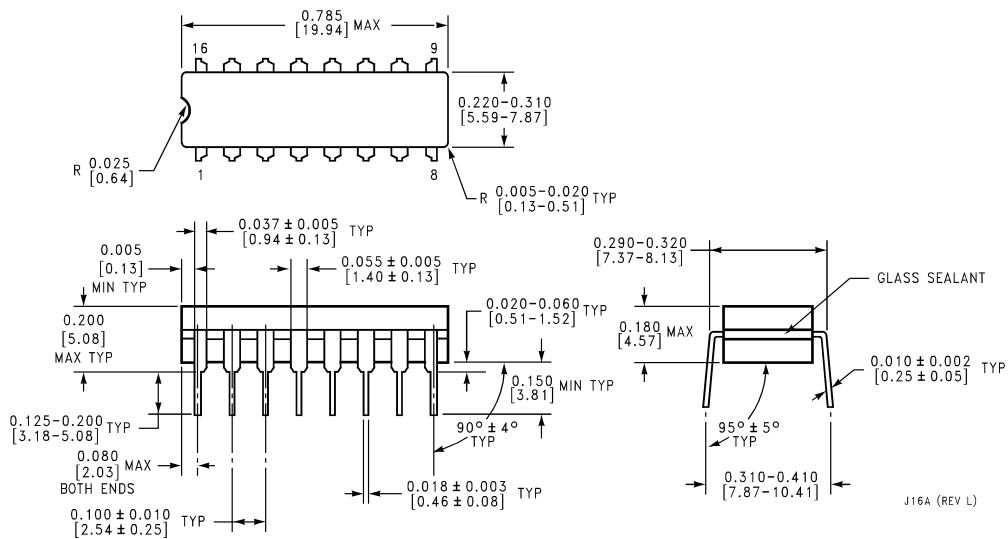

16 Lead Ceramic Dual-In-Line Package (D)
 NS Package Number J16A

J16A (REV L)

Physical Dimensions inches (millimeters) unless otherwise noted (Continued)

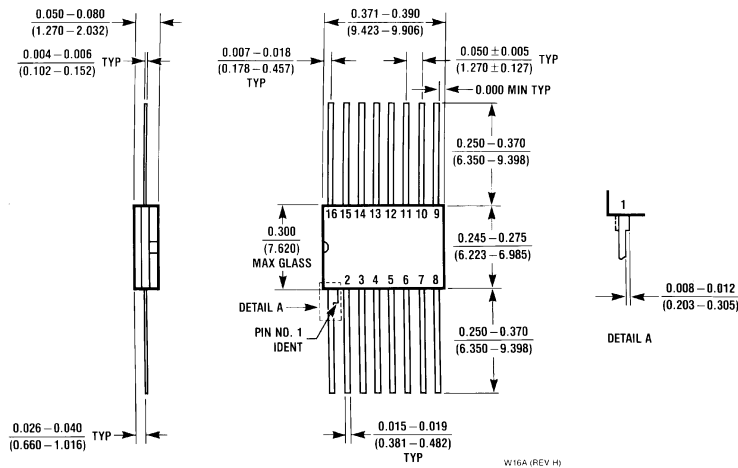

**16 Lead Ceramic Flatpak (F)
NS Package Number W16A**

LIFE SUPPORT POLICY

NATIONAL'S PRODUCTS ARE NOT AUTHORIZED FOR USE AS CRITICAL COMPONENTS IN LIFE SUPPORT DEVICES OR SYSTEMS WITHOUT THE EXPRESS WRITTEN APPROVAL OF THE PRESIDENT OF NATIONAL SEMICONDUCTOR CORPORATION. As used herein:

1. Life support devices or systems are devices or systems which, (a) are intended for surgical implant into the body, or (b) support or sustain life, and whose failure to perform when properly used in accordance with instructions for use provided in the labeling, can be reasonably expected to result in a significant injury to the user.
2. A critical component in any component of a life support device or system whose failure to perform can be reasonably expected to cause the failure of the life support device or system, or to affect its safety or effectiveness.



National Semiconductor Corporation
Americas
Tel: 1-800-272-9959
Fax: 1-800-737-7018
Email: support@nsc.com

National Semiconductor Europe
Fax: +49 (0) 1 80-530 85 86
Email: europe.support@nsc.com
Deutsch Tel: +49 (0) 1 80-530 85 85
English Tel: +49 (0) 1 80-532 78 32
Français Tel: +49 (0) 1 80-532 93 58
Italiano Tel: +49 (0) 1 80-534 16 80

National Semiconductor Asia Pacific Customer Response Group
Tel: 65-2544466
Fax: 65-2504466
Email: sea.support@nsc.com

National Semiconductor Japan Ltd.
Tel: 81-3-5620-6175
Fax: 81-3-5620-6179

www.national.com

Product Folder

54AC251 8-Input Multiplexer with TRI-STATE Output

Contents

- [General Description](#)
- [Features](#)
- [Datasheet](#)
- [Package Availability, Models, Samples & Pricing](#)

General Description

The 'AC'/ACT251 is a high-speed 8-input digital multiplexer. It provides, in one package, the ability to select one bit of data from up to eight sources. It can be used as universal function generator to generate any logic function of four variables. Both true and complementary outputs are provided.

Features

- I_{CC} reduced by 50%
- Multifunctional capability
- On-chip select logic decoding
- Inverting and noninverting TRI-STATE outputs
- Outputs source/sink 24 mA
- 'ACT251 has TTL-compatible inputs
- Standard Military Drawing (SMD) -'AC251: 5962-87692 -'ACT251: 5962-89599

Datasheet

Title	Size (in Kbytes)	Date	<input type="checkbox"/> View Online	<input type="checkbox"/> Download	<input type="checkbox"/> Receive via Email
54AC251 54ACT251 8-Input Multiplexer with TRI-STATE Output	158 Kbytes	24-Aug-98	View Online	Download	Receive via Email

Please use [Adobe Acrobat](#) to view PDF file(s).

If you have trouble printing, see [Printing Problems](#).

Package Availability, Models, Samples & Pricing

Part Number	Package		Status	Models		Samples & Electronic Orders	Budgetary Pricing		Std Pack Size	Package Marking
	Type	# pins		SPICE	IBIS		Quantity	\$US each		
54AC251LMQB-RH	LCC	20	Full production	N/A	N/A	.			tube of N/A	[logo]çZçSç4çA 54AC251 LMQB-RH R87692012A QçM\$E
5962-87692012A	LCC	20	Full production	N/A	N/A	Order Parts	50+	\$8.0000	tube of 50	[logo]çZçSç4çA 54AC251 LMQB /QçM\$E 5962- 87692012A
54AC251DMQB-RH	Cerdip	16	Full production	N/A	N/A	.			tube of N/A	[logo]çZçSç4çA\$E 54AC251DMQB-RH QçM 5962R8769201EA
5962-8769201EA	Cerdip	16	Full production	N/A	N/A	.	50+	\$6.4000	tube of 25	[logo]çZçSç4çA\$E 54AC251DMQB /QçM 5962-8769201EA
54AC251FMQB-RH	Cerpack	16	Full production	N/A	N/A	.			tube of N/A	[logo]çZçSç4çA\$E 54AC251FMQB -RH /QçM 5962 R8769201FA
5962-8769201FA	Cerpack	16	Full production	N/A	N/A	Order Parts	50+	\$8.0000	tube of 19	[logo]çZçSç4çA\$E 54AC251FMQB QçM 5962- 8769201FA
5962R8769201V2A	LCC	20	Full production	N/A	N/A	.	50+	\$138.0000	tube of 50	[logo]çZçSç4çA 54AC251E RQMLV \$E 5962R 8769201V2A
5962R8769201VEA	Cerdip	16	Full production	N/A	N/A	.	50+	\$138.0000	tube of 25	[logo]çZçSç4çA\$E 54AC251JRQMLV 5962R8769201VEA
RM54AC251VFA	Cerpack	16	Preliminary	N/A	N/A	.			tube of N/A	[logo]çZçSç4çA\$E RM54AC251VFA çR WAFER #
5962R8769201VFA	Cerpack	16	Full production	N/A	N/A	.	50+	\$138.0000	tube of 19	[logo]çZçSç4çA\$E 54AC251W RQMLV 5962 R8769201VFA
54AC251FM-MLS	Cerpack	16	Lifetime buy	N/A	N/A	.	50+	\$152.0000	tube of 19	[logo]çZçSç4çA\$E 54AC251FM- MLS

[Information as of 6-Dec-2000]

Quick Search

[Parametric
Search](#)

[System
Diagrams](#)

[Product
Tree](#)

[Home](#)

[About Languages](#) . [About the Site](#) . [About "Cookies"](#)

[National is QS 9000 Certified](#) . [Privacy/Security](#)

[Copyright © National Semiconductor Corporation](#)

[Preferences](#) . [Feedback](#)