

54AC821 • 54ACT821 10-Bit D Flip-Flop with TRI-STATE® Outputs

General Description

The 'AC/'ACT821 is a 10-bit D flip-flop with TRI-STATE outputs arranged in a broadside pinout.

The 'AC/'ACT821 is functionally identical to the AM29821.

Features

- TRI-STATE outputs for bus interfacing

- Noninverting outputs
- Outputs source/sink 24 mA
- 'ACT821 has TTL-compatible inputs
- Standard Microcircuit Drawing (SMD)
 - 'ACT821: 5962-88705
 - 'AC821: 5962-91606

Logic Symbols

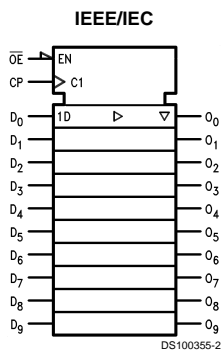
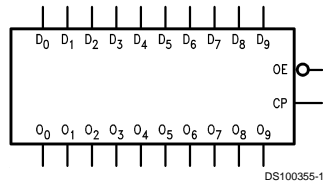

Pin Names	Description
D ₀ –D ₉	Data Inputs
O ₀ –O ₉	Data Outputs
\overline{OE}	Output Enable Input
CP	Clock Input

Connection Diagrams

Pin Assignment for DIP and Flatpak

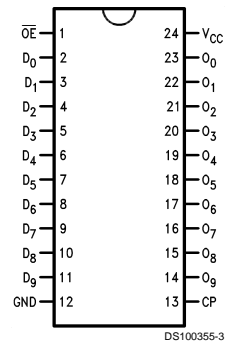

Pin Assignment for LCC

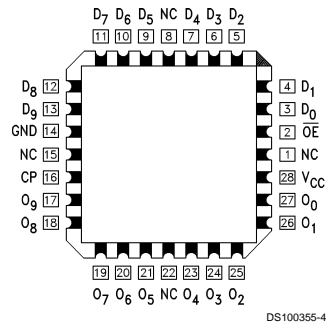

TRI-STATE® is a registered trademark of National Semiconductor Corporation.
FACT® is a registered trademark of Fairchild Semiconductor Corporation.

Functional Description

The 'AC/ACT821 consists of ten D-type edge-triggered flip-flops. The buffered Clock (CP) and buffered Output Enable (\overline{OE}) are common to all flip-flops. The flip-flops will store the state of their individual D inputs that meet the setup and hold time requirements on the LOW-to-HIGH CP transition. With \overline{OE} LOW the contents of the flip-flops are available at

the outputs. When \overline{OE} is HIGH the outputs go to the high impedance state. Operation of the \overline{OE} input does not affect the state of the flip-flops.

The 'AC/ACT821 is functionally and pin compatible with the AM29821.

Function Table

\overline{OE}	Inputs		Internal Q	Outputs O	Function
	CP	D			
H	↗	L	L	Z	High Z
H	↗	H	H	Z	High Z
L	↗	L	L	L	Load
L	↗	H	H	H	Load

H = HIGH Voltage Level
 L = LOW Voltage Level
 Z = HIGH Impedance
 ↗ = LOW-to-HIGH Clock Transition

Logic Diagram

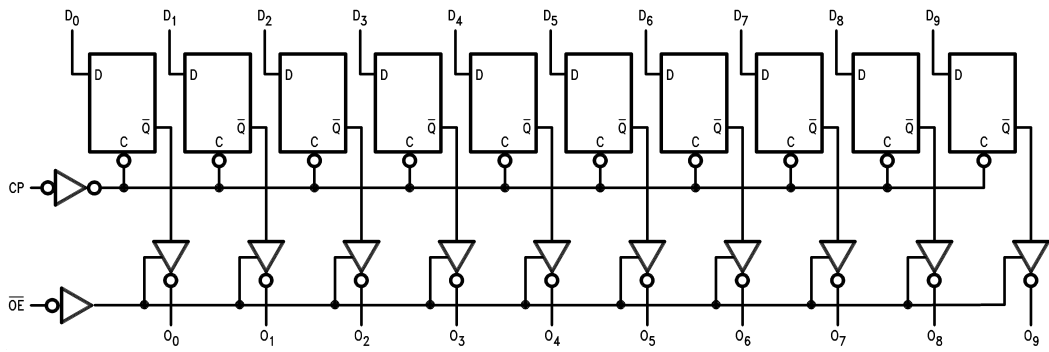

DS100355-5

Please note that this diagram is provided only for the understanding of logic operations and should not be used to estimate propagation delays.

Absolute Maximum Ratings (Note 1)

If Military/Aerospace specified devices are required, please contact the National Semiconductor Sales Office/Distributors for availability and specifications.

Supply Voltage (V_{CC})	-0.5V to +7.0V
DC Input Diode Current (I_{IK})	
$V_I = -0.5V$	-20 mA
$V_I = V_{CC} + 0.5V$	+20 mA
DC Input Voltage (V_I)	-0.5V to $V_{CC} + 0.5V$
DC Output Diode Current (I_{OK})	
$V_O = -0.5V$	-20 mA
$V_O = V_{CC} + 0.5V$	+20 mA
DC Output Voltage (V_O)	-0.5V to $V_{CC} + 0.5V$
DC Output Source or Sink Current (I_O)	±50 mA
DC V_{CC} or Ground Current per Output Pin (I_{CC} or I_{GND})	±50 mA
Storage Temperature (T_{STG})	-65°C to +150°C
Junction Temperature (T_J)	
CDIP	175°C

Recommended Operating Conditions

Supply Voltage (V_{CC})	
'AC	2.0V to 6.0V
'ACT	4.5V to 5.5V
Input Voltage (V_I)	0V to V_{CC}
Output Voltage (V_O)	0V to V_{CC}
Operating Temperature (T_A)	
54AC/ACT	-55°C to +125°C
Minimum Input Edge Rate ($\Delta V/\Delta t$)	
'AC Devices	
V_{IN} from 30% to 70% of V_{CC}	
V_{CC} @ 3.3V, 4.5V, 5.5V	125 mV/ns
Minimum Input Edge Rate ($\Delta V/\Delta t$)	
'ACT Devices	
V_{IN} from 0.8V to 2.0V	
V_{CC} @ 4.5V, 5.5V	125 mV/ns

Note 1: Absolute maximum ratings are those values beyond which damage to the device may occur. The databook specifications should be met, without exception, to ensure that the system design is reliable over its power supply, temperature, and output/input loading variables. National does not recommend operation of FACT® circuits outside databook specifications.

DC Characteristics for 'AC Family Devices

Symbol	Parameter	V_{CC} (V)	54AC		Units	Conditions	
			$T_A = -55^\circ\text{C to } +125^\circ\text{C}$				
			Guaranteed Limits				
V_{IH}	Minimum High Level Input Voltage	3.0	2.1		V	$V_{OUT} = 0.1V$ or $V_{CC} - 0.1V$	
		4.5	3.15				
		5.5	3.85				
V_{IL}	Maximum Low Level Input Voltage	3.0	0.9		V	$V_{OUT} = 0.1V$ or $V_{CC} - 0.1V$	
		4.5	1.35				
		5.5	1.65				
V_{OH}	Minimum High Level Output Voltage	3.0	2.9		V	$I_{OUT} = -50 \mu A$	
		4.5	4.4				
		5.5	5.4				
			3.0	2.4		V	(Note 2) $V_{IN} = V_{IL}$ or V_{IH} $I_{OH} = -12 \text{ mA}$ $I_{OH} = -24 \text{ mA}$ $I_{OH} = -24 \text{ mA}$
			4.5	3.7			
			5.5	4.7			
V_{OL}	Maximum Low Level Output Voltage	3.0	0.1		V	$I_{OUT} = 50 \mu A$	
		4.5	0.1				
		5.5	0.1				
			3.0	0.50		V	(Note 2) $V_{IN} = V_{IL}$ or V_{IH} $I_{OL} = 12 \text{ mA}$ $I_{OL} = 24 \text{ mA}$ $I_{OL} = 24 \text{ mA}$
			4.5	0.50			
			5.5	0.50			
I_{IN}	Maximum Input Leakage Current	5.5	±1.0		μA	$V_I = V_{CC}, \text{ GND}$	
I_{OZ}	Maximum TRI-STATE Current	5.5	±10.0		μA	$V_I (\text{OE}) = V_{IL}, V_{IH}$ $V_I = V_{CC}, \text{ GND}$ $V_O = V_{CC}, \text{ GND}$	

DC Characteristics for 'AC Family Devices (Continued)

Symbol	Parameter	V _{CC} (V)	54AC		Units	Conditions
			T _A = -55°C to +125°C			
			Guaranteed Limits			
I _{OLD}	(Note 3) Minimum Dynamic Output Current	5.5	50		mA	V _{OLD} = 1.65V Max
I _{OHD}	Output Current	5.5	-50			
I _{CC}	Maximum Quiescent Supply Current	5.5	160.0		μA	V _{IN} = V _{CC} or GND

Note 2: All outputs loaded; thresholds on input associated with output under test.

Note 3: Maximum test duration 2.0 ms, one output loaded at a time.

Note 4: I_{IN} and I_{CC} @ 3.0V are guaranteed to be less than or equal to the respective limit @ 5.5V V_{CC}.

I_{CC} for 54AC @ 25°C is identical to 74AC @ 25°C.

DC Characteristics for 'ACT Family Devices

Symbol	Parameter	V _{CC} (V)	54ACT		Units	Conditions
			T _A = -55°C to +125°C			
			Guaranteed Limits			
V _{IH}	Minimum High Level Input Voltage	4.5	2.0		V	V _{OUT} = 0.1V or V _{CC} - 0.1V
		5.5	2.0			
V _{IL}	Maximum Low Level Input Voltage	4.5	0.8		V	V _{OUT} = 0.1V or V _{CC} - 0.1V
		5.5	0.8			
V _{OH}	Minimum High Level Output Voltage	4.5	4.4		V	I _{OUT} = -50 μA
		5.5	5.4			
		4.5	3.70		V	(Note 5) V _{IN} = V _{IL} or V _{IH} I _{OH} = -24 mA I _{OH} = -24 mA
		5.5	4.70			
V _{OL}	Maximum Low Level Output Voltage	4.5	0.1		V	I _{OUT} = 50 μA
		5.5	0.1			
		4.5	0.50		V	(Note 5) V _{IN} = V _{IL} or V _{IH} I _{OL} = 24 mA I _{OL} = 24 mA
		5.5	0.50			
I _{IN}	Maximum Input Leakage Current	5.5	±1.0		μA	V _I = V _{CC} , GND
I _{OZ}	Maximum TRI-STATE Current	5.5	±10.0		μA	V _I = V _{IL} , V _{IH} V _O = V _{CC} , GND
I _{CCT}	Maximum I _{CC} /Input	5.5	1.6		mA	V _I = V _{CC} - 2.1V
I _{OLD}	(Note 6) Minimum Dynamic Output Current	5.5	50		mA	V _{OLD} = 1.65V Max
I _{OHD}	Output Current	5.5	-50			
I _{CC}	Maximum Quiescent Supply Current	5.5	160.0		μA	V _{IN} = V _{CC} or GND

Note 5: All outputs loaded; thresholds on input associated with output under test.

Note 6: Maximum test duration 2.0 ms, one output loaded at a time.

Note 7: I_{CC} for 54ACT @ 25°C is identical to 74ACT @ 25°C.

AC Electrical Characteristics

Symbol	Parameter	V _{CC} (V) (Note 8)	54AC		Units	Fig. No.
			T _A = -55°C to +125°C C _L = 50 pF			
			Min	Max		
f _{max}	Maximum Clock Frequency	3.3	95		MHz	
		5.0	100			
t _{PLH}	Propagation Delay CP to O _n	3.3	1.0	13.0	ns	
		5.0	1.5	9.5		
t _{PHL}	Propagation Delay CP to O _n	3.3	1.0	13.0	ns	
		5.0	1.5	9.5		
t _{PZH}	Output Enable Time OE to O _n	3.3	1.0	13.0	ns	
		5.0	1.5	9.5		
t _{PZL}	Output Enable Time OE to O _n	3.3	1.0	13.0	ns	
		5.0	1.5	9.5		
t _{PHZ}	Output Disable Time OE to O _n	3.3	1.0	12.0	ns	
		5.0	1.5	10.0		
t _{PLZ}	Output Disable Time OE to O _n	3.3	1.0	12.0	ns	
		5.0	1.5	10.0		

Note 8: Voltage Range 3.3 is 3.3V ±0.3V

Note 9: Voltage Range 5.0 is 5.0V ±0.5V

AC Operating Requirements

Symbol	Parameter	V _{CC} (V) (Note 10)	54AC		Units	Fig. No.
			T _A = -55°C to +125°C C _L = 50 pF			
			Guaranteed Minimum			
t _s	Setup Time, HIGH or LOW D _n to CP	3.3	3.0		ns	
		5.0	3.0			
t _h	Hold Time, HIGH or LOW D _n to CP	3.3	3.0		ns	
		5.0	3.0			
t _w	CP Pulse Width HIGH or LOW	3.3	6.0		ns	
		5.0	5.0			

Note 10: Voltage Range 3.3 is 3.3V ±0.3V

Note 11: Voltage Range 5.0 is 5.0V ±0.5V

AC Electrical Characteristics

Symbol	Parameter	V _{CC} (V) (Note 12)	54ACT		Units	Fig. No.
			T _A = -55°C to +125°C C _L = 50 pF			
			Min	Max		
f _{max}	Maximum Clock Frequency	5.0	85		MHz	
t _{PLH}	Propagation Delay CP to O _n	5.0	1.5	11.5	ns	
t _{PHL}	Propagation Delay CP to O _n	5.0	1.5	11.5	ns	
t _{PZH}	Output Enable Time OE to O _n	5.0	1.5	12.5	ns	

AC Electrical Characteristics (Continued)

Symbol	Parameter	V _{CC} (V) (Note 12)	54ACT		Units	Fig. No.
			T _A = -55°C to +125°C C _L = 50 pF			
			Min	Max		
t _{PZL}	Output Enable Time O _E to O _n	5.0	1.5	13.0	ns	
t _{PHZ}	Output Disable Time O _E to O _n	5.0	1.5	13.5	ns	
t _{PLZ}	Output Disable Time O _E to O _n	5.0	1.5	12.5	ns	

Note 12: Voltage Range 5.0 is 5.0V ±0.5V

AC Operating Requirements

Symbol	Parameter	V _{CC} (V) (Note 13)	54ACT		Units	Fig. No.
			T _A = -55°C to +125°C C _L = 50 pF			
			Guaranteed Minimum			
t _s	Setup Time, HIGH or LOW D _n to CP	5.0	4.0		ns	
t _h	Hold Time, HIGH or LOW D _n to CP	5.0	3.0		ns	
t _w	CP Pulse Width HIGH or LOW	5.0	6.0		ns	

Note 13: Voltage Range 5.0 is 5.0V ±0.5V

Capacitance

Symbol	Parameter	Typ	Units	Conditions
C _{IN}	Input Capacitance	4.5	pF	V _{CC} = OPEN
C _{PD}	Power Dissipation Capacitance	35.0	pF	V _{CC} = 5.0V

Physical Dimensions inches (millimeters) unless otherwise noted

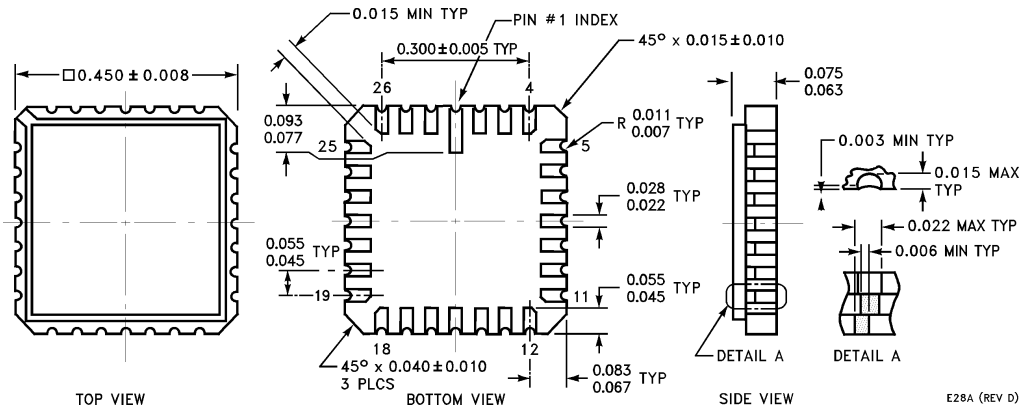

28 Terminal Ceramic Leadless Chip Carrier (L)
NS Package Number E28A

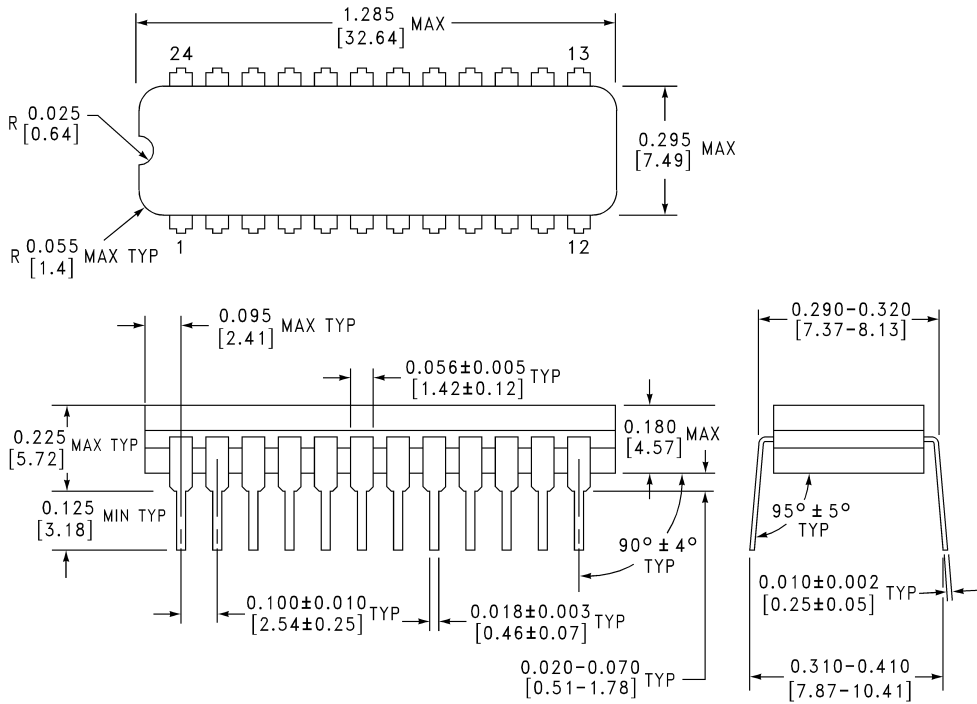

24 Lead Slim (0.300" Wide) Ceramic Dual-In-Line Package (SD)
NS Package Number J24F

Physical Dimensions inches (millimeters) unless otherwise noted (Continued)

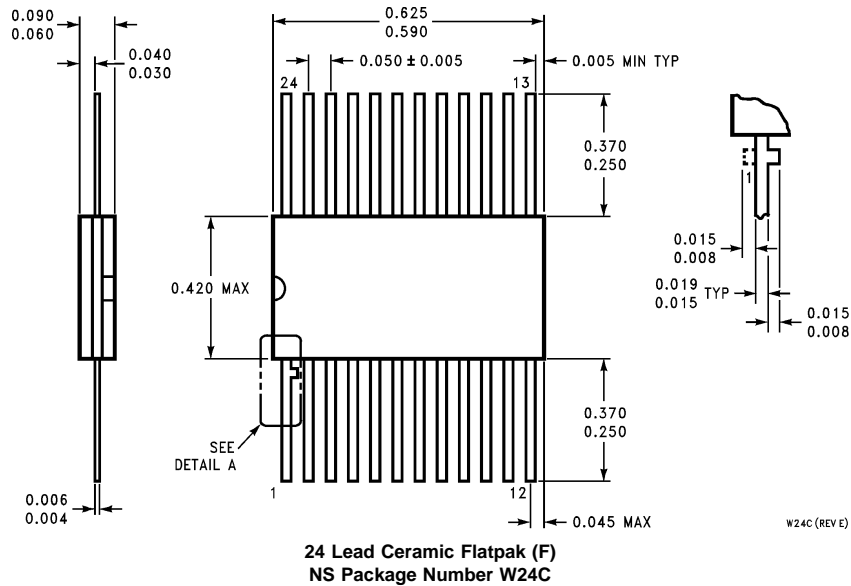

W24C (REV E)

LIFE SUPPORT POLICY

NATIONAL'S PRODUCTS ARE NOT AUTHORIZED FOR USE AS CRITICAL COMPONENTS IN LIFE SUPPORT DEVICES OR SYSTEMS WITHOUT THE EXPRESS WRITTEN APPROVAL OF THE PRESIDENT OF NATIONAL SEMICONDUCTOR CORPORATION. As used herein:

1. Life support devices or systems are devices or systems which, (a) are intended for surgical implant into the body, or (b) support or sustain life, and whose failure to perform when properly used in accordance with instructions for use provided in the labeling, can be reasonably expected to result in a significant injury to the user.
2. A critical component in any component of a life support device or system whose failure to perform can be reasonably expected to cause the failure of the life support device or system, or to affect its safety or effectiveness.



National Semiconductor Corporation
Americas
Tel: 1-800-272-9959
Fax: 1-800-737-7018
Email: support@nsc.com

National Semiconductor Europe
Fax: +49 (0) 1 80-530 85 86
Email: europe.support@nsc.com
Deutsch Tel: +49 (0) 1 80-530 85 85
English Tel: +49 (0) 1 80-532 78 32
Français Tel: +49 (0) 1 80-532 93 58
Italiano Tel: +49 (0) 1 80-534 16 80

National Semiconductor Asia Pacific Customer Response Group
Tel: 65-2544466
Fax: 65-2504466
Email: sea.support@nsc.com

National Semiconductor Japan Ltd.
Tel: 81-3-5620-6175
Fax: 81-3-5620-6179

www.national.com

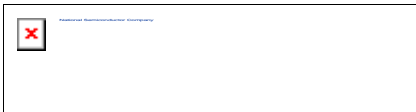

54AC821 10-Bit D Flip-Flop with TRI-STATE Outputs

Contents

- [General Description](#)
- [Features](#)
- [Datasheet](#)
- [Package Availability, Models, Samples & Pricing](#)

General Description



The 'AC/'ACT821 is a 10-bit D flip-flop with TRI-STATE outputs arranged in a broadside pinout.

The 'AC/'ACT821 is functionally identical to the AM29821.

Features



- TRI-STATE outputs for bus interfacing
 - Noninverting outputs
 - Outputs source/sink 24 mA
 - 'ACT821 has TTL-compatible inputs
 - Standard Microcircuit Drawing (SMD) -'ACT821: 5962-88705 -'AC821: 5962-91606
-

Datasheet

Title	Size (in Kbytes)	Date	 View Online	 Download	 Receive via Email
54AC821 54ACT821 10-Bit D Flip-Flop with TRI-STATE Outputs	163 Kbytes	14-Aug-98	View Online	Download	Receive via Email

Please use [Adobe Acrobat](#) to view PDF file(s).
If you have trouble printing, see [Printing Problems](#).

Package Availability, Models, Samples & Pricing

Part Number	Package		Status	Models		Samples & Electronic Orders	Budgetary Pricing		Std Pack Size	Package Marking
	Type	# pins		SPICE	IBIS		Quantity	\$US each		
5962-9160601M3A	LCC	28	Full production	N/A	N/A		50+	\$16.0000	tray of 25	[logo]ZçSç4çA 54AC821 LMQB /QçM\$E 5962- 9160601M3A
5962-9160601MLA	Cerdip	24	Full production	N/A	N/A		50+	\$10.9000	tube of 15	[logo]ZçSç4çA\$E 54AC821SDMQB /QçM 5962-9160601MLA
5962-9160601MKA	Cerpack	24	Full production	N/A	N/A		50+	\$16.0000	tube of 19	[logo]ZçSç4çA\$E 54AC821FMQB QçM 5962- 9160601MKA

[Information as of 1-Sep-2000]

Quick Search

[Parametric Search](#)

[System Diagrams](#)

[Product Tree](#)

[Home](#)

[About Languages](#) . [About the Site](#) . [About "Cookies"](#)
National is [QS 9000 Certified](#) . [Privacy/Security](#)
[Copyright © National Semiconductor Corporation](#)
 [Preferences](#) . [Feedback](#)