



## 54AC/74AC821 • 54ACT/74ACT821 10-Bit D Flip-Flop with TRI-STATE® Outputs

### General Description

The 'AC/'ACT821 is a 10-bit D flip-flop with TRI-STATE outputs arranged in a broadside pinout.

The 'AC/'ACT821 is functionally identical to the AM29821.

### Features

- TRI-STATE outputs for bus interfacing
- Noninverting outputs
- Outputs source/sink 24 mA
- 'ACT821 has TTL-compatible inputs
- Standard Military Drawing (SMD)
  - 'ACT821: 5962-88705

**Ordering Code:** See Section 8

### Logic Symbols

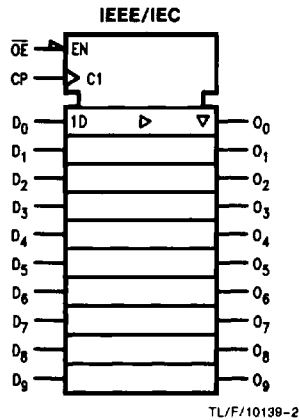
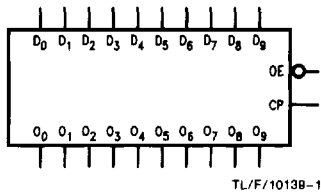

### Connection Diagrams

Pin Assignment  
for DIP, Flatpak and SOIC

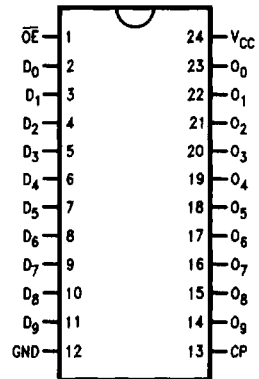

Pin Names	Description
D <sub>0</sub> -D <sub>9</sub>	Data Inputs
O <sub>0</sub> -O <sub>9</sub>	Data Outputs
OE	Output Enable Input
CP	Clock Input

Pin Assignment  
for LCC

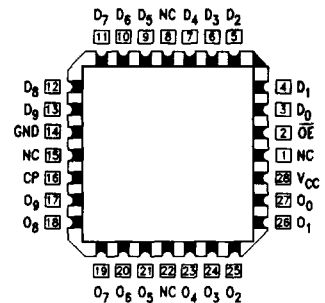





## Functional Description

The 'AC/'ACT821 consists of ten D-type edge-triggered flip-flops. The buffered Clock (CP) and buffered Output Enable ( $\overline{OE}$ ) are common to all flip-flops. The flip-flops will store the state of their individual D inputs that meet the setup and hold time requirements on the LOW-to-HIGH CP transition. With  $\overline{OE}$  LOW the contents of the flip-flops are available at

the outputs. When  $\overline{OE}$  is HIGH the outputs go to the high impedance state. Operation of the  $\overline{OE}$  input does not affect the state of the flip-flops.

The 'AC/'ACT821 is functionally and pin compatible with the AM29821.

Function Table

Inputs			Internal	Outputs	Function
$\overline{OE}$	CP	D	Q	O	
H		L	L	Z	High Z
H		H	H	Z	High Z
L		L	L	L	Load
L		H	H	H	Load

H = HIGH Voltage Level  
 L = LOW Voltage Level  
 Z = HIGH Impedance  
 = LOW-to-HIGH Clock Transition

## Logic Diagram

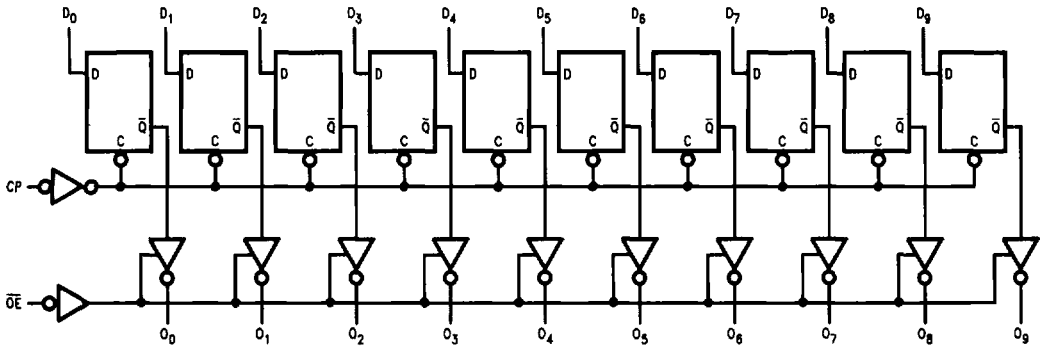

TL/F/10139-5

Please note that this diagram is provided only for the understanding of logic operations and should not be used to estimate propagation delays.

**Absolute Maximum Rating** (Note 1)

If Military/Aerospace specified devices are required, please contact the National Semiconductor Sales Office/Distributors for availability and specifications.

Supply Voltage ( $V_{CC}$ )	-0.5V to +7.0V
DC Input Diode Current ( $I_{IK}$ )	
$V_I = -0.5V$	-20 mA
$V_I = V_{CC} + 0.5V$	+20 mA
DC Input Voltage ( $V_I$ )	-0.5V to $V_{CC} + 0.5V$
DC Output Diode Current ( $I_{OK}$ )	
$V_O = -0.5V$	-20 mA
$V_O = V_{CC} + 0.5V$	+20 mA
DC Output Voltage ( $V_O$ )	-0.5V to $V_{CC} + 0.5V$
DC Output Source or Sink Current ( $I_O$ )	$\pm 50$ mA
DC $V_{CC}$ or Ground Current per Output Pin ( $I_{CC}$ or $I_{GND}$ )	$\pm 50$ mA
Storage Temperature ( $T_{STG}$ )	-65°C to +150°C
Junction Temperature ( $T_J$ )	
CDIP	175°C
PDIP	140°C

Note 1: Absolute maximum ratings are those values beyond which damage to the device may occur. The databook specifications should be met, without exception, to ensure that the system design is reliable over its power supply, temperature, and output/input loading variables. National does not recommend operation of FACT™ circuits outside databook specifications.

**Recommended Operating Conditions**

Supply Voltage ( $V_{CC}$ )	
'AC	2.0V to 6.0V
'ACT	4.5V to 5.5V
Input Voltage ( $V_I$ )	0V to $V_{CC}$
Output Voltage ( $V_O$ )	0V to $V_{CC}$
Operating Temperature ( $T_A$ )	
74AC/ACT	-40°C to +85°C
54AC/ACT	-55°C to +125°C
Minimum Input Edge Rate ( $\Delta V/\Delta t$ )	
'AC Devices	
$V_{IN}$ from 30% to 70% of $V_{CC}$	
$V_{CC}$ @ 3.3V, 4.5V, 5.5V	125 mV/ns
Minimum Input Edge Rate ( $\Delta V/\Delta t$ )	
'ACT Devices	
$V_{IN}$ from 0.8V to 2.0V	
$V_{CC}$ @ 4.5V, 5.5V	125 mV/ns

**DC Characteristics for 'AC Family Devices**

Symbol	Parameter	$V_{CC}$ (V)	74AC		54AC		74AC		Units	Conditions	
			$T_A = +25^\circ\text{C}$		$T_A = -55^\circ\text{C to } +125^\circ\text{C}$		$T_A = -40^\circ\text{C to } +85^\circ\text{C}$				
			Typ	Guaranteed Limits							
$V_{IH}$	Minimum High Level Input Voltage	3.0	1.5	2.1	2.1		2.1		V	$V_{OUT} = 0.1V$ or $V_{CC} - 0.1V$	
		4.5	2.25	3.15	3.15		3.15				
		5.5	2.75	3.85	3.85		3.85				
$V_{IL}$	Maximum Low Level Input Voltage	3.0	1.5	0.9	0.9		0.9		V	$V_{OUT} = 0.1V$ or $V_{CC} - 0.1V$	
		4.5	2.25	1.35	1.35		1.35				
		5.5	2.75	1.65	1.65		1.65				
$V_{OH}$	Minimum High Level Output Voltage	3.0	2.99	2.9	2.9		2.9		V	$I_{OUT} = -50 \mu\text{A}$	
		4.5	4.49	4.4	4.4		4.4				
		5.5	5.49	5.4	5.4		5.4				
			3.0		2.56	2.4		2.46		V	* $V_{IN} = V_{IL}$ or $V_{IH}$ -12 mA $I_{OH}$ -24 mA -24 mA
			4.5		3.86	3.7		3.76			
			5.5		4.86	4.7		4.76			
$V_{OL}$	Maximum Low Level Output Voltage	3.0	0.002	0.1	0.1		0.1		V	$I_{OUT} = 50 \mu\text{A}$	
		4.5	0.001	0.1	0.1		0.1				
		5.5	0.001	0.1	0.1		0.1				
			3.0		0.36	0.50		0.44		V	* $V_{IN} = V_{IL}$ or $V_{IH}$ 12 mA $I_{OL}$ 24 mA 24 mA
			4.5		0.36	0.50		0.44			
			5.5		0.36	0.50		0.44			
$I_{IN}$	Maximum Input Leakage Current	5.5		$\pm 0.1$	$\pm 1.0$		$\pm 1.0$		$\mu\text{A}$	$V_I = V_{CC}, \text{GND}$	

\*All outputs loaded; thresholds on input associated with output under test.

†Maximum test duration 2.0 ms, one output loaded at a time.

## DC Characteristics for 'AC Family Devices (Continued)

Symbol	Parameter	V <sub>CC</sub> (V)	74AC		54AC	74AC	Units	Conditions
			T <sub>A</sub> = +25°C		T <sub>A</sub> = -55°C to +125°C	T <sub>A</sub> = -40°C to +85°C		
			Typ	Guaranteed Limits				
I <sub>OZ</sub>	Maximum TRI-STATE® Current	5.5		±0.5	±10.0	±5.0	μA	V <sub>I</sub> (OE) = V <sub>IL</sub> , V <sub>IH</sub> V <sub>I</sub> = V <sub>CC</sub> , GND V <sub>O</sub> = V <sub>CC</sub> , GND
I <sub>OLD</sub>	†Minimum Dynamic Output Current	5.5			50	75	mA	V <sub>OLD</sub> = 1.65V Max
I <sub>OHD</sub>		5.5			-50	-75	mA	V <sub>OHD</sub> = 3.85V Min
I <sub>CC</sub>	Maximum Quiescent Supply Current	5.5		8.0	160.0	80.0	μA	V <sub>IN</sub> = V <sub>CC</sub> or GND

\*All outputs loaded; thresholds on input associated with output under test.

†Maximum test duration 2.0 ms, one output loaded at a time.

Note: I<sub>IN</sub> and I<sub>CC</sub> @ 3.0V are guaranteed to be less than or equal to the respective limit @ 5.5V V<sub>CC</sub>.

I<sub>CC</sub> for 54AC @ 25°C is identical to 74AC @ 25°C.

## DC Characteristics for 'ACT Family Devices

Symbol	Parameter	V <sub>CC</sub> (V)	74ACT		54ACT	74ACT	Units	Conditions
			T <sub>A</sub> = +25°C		T <sub>A</sub> = -55°C to +125°C	T <sub>A</sub> = -40°C to +85°C		
			Typ	Guaranteed Limits				
V <sub>IH</sub>	Minimum High Level Input Voltage	4.5	1.5	2.0	2.0	2.0	V	V <sub>OUT</sub> = 0.1V or V <sub>CC</sub> - 0.1V
		5.5	1.5	2.0	2.0	2.0		
V <sub>IL</sub>	Maximum Low Level Input Voltage	4.5	1.5	0.8	0.8	0.8	V	V <sub>OUT</sub> = 0.1V or V <sub>CC</sub> - 0.1V
		5.5	1.5	0.8	0.8	0.8		
V <sub>OH</sub>	Minimum High Level Output Voltage	4.5	4.49	4.4	4.4	4.4	V	I <sub>OUT</sub> = -50 μA
		5.5	5.49	5.4	5.4	5.4		
		4.5		3.86	3.70	3.76	V	*V <sub>IN</sub> = V <sub>IL</sub> or V <sub>IH</sub> -24 mA I <sub>OH</sub> -24 mA
		5.5		4.86	4.70	4.76		
V <sub>OL</sub>	Maximum Low Level Output Voltage	4.5	0.001	0.1	0.1	0.1	V	I <sub>OUT</sub> = 50 μA
		5.5	0.001	0.1	0.1	0.1		
		4.5		0.36	0.50	0.44	V	*V <sub>IN</sub> = V <sub>IL</sub> or V <sub>IH</sub> 24 mA I <sub>OL</sub> 24 mA
		5.5		0.36	0.50	0.44		
I <sub>IN</sub>	Maximum Input Leakage Current	5.5		±0.1	±1.0	±1.0	μA	V <sub>I</sub> = V <sub>CC</sub> , GND
I <sub>OZ</sub>	Maximum TRI-STATE® Current	5.5		±0.5	±10.0	±5.0	μA	V <sub>I</sub> = V <sub>IL</sub> , V <sub>IH</sub> V <sub>O</sub> = V <sub>CC</sub> , GND
I <sub>CCT</sub>	Maximum I <sub>CC</sub> /Input	5.5	0.6		1.6	1.5	mA	V <sub>I</sub> = V <sub>CC</sub> - 2.1V
I <sub>OLD</sub>	†Minimum Dynamic Output Current	5.5			50	75	mA	V <sub>OLD</sub> = 1.65V Max
I <sub>OHD</sub>		5.5			-50	-75	mA	V <sub>OHD</sub> = 3.85V Min
I <sub>CC</sub>	Maximum Quiescent Supply Current	5.5		8.0	160.0	80.0	μA	V <sub>IN</sub> = V <sub>CC</sub> or GND

\*All outputs loaded; thresholds on input associated with output under test.

†Maximum test duration 2.0 ms, one output loaded at a time.

Note: I<sub>CC</sub> for 54ACT @ 25°C is identical to 74ACT @ 25°C.

**AC Electrical Characteristics:** See Section 2 for Waveforms

Symbol	Parameter	V <sub>CC</sub> * (V)	74AC			54AC		74AC		Units	Fig. No.
			T <sub>A</sub> = +25°C C <sub>L</sub> = 50 pF			T <sub>A</sub> = -55°C to +125°C C <sub>L</sub> = 50 pF		T <sub>A</sub> = -40°C to +85°C C <sub>L</sub> = 50 pF			
			Min	Typ	Max	Min	Max	Min	Max		
f <sub>max</sub>	Maximum Clock Frequency	3.3 5.0	110 120	145 160		95 100		100 110	MHz		
t <sub>PLH</sub>	Propagation Delay CP to O <sub>n</sub>	3.3 5.0	3.0 2.0	8.0 6.0	13.0 9.5	1.0 1.0	16.0 11.5	3.0 2.0	15.0 10.5	ns	2-3, 4
t <sub>PHL</sub>	Propagation Delay CP to O <sub>n</sub>	3.3 5.0	3.0 2.0	8.0 5.5	13.0 9.5	1.0 1.0	16.0 11.5	3.0 2.0	15.0 10.5	ns	2-3, 4
t <sub>PZH</sub>	Output Enable Time OE to O <sub>n</sub>	3.3 5.0	2.5 1.5	6.0 4.5	11.0 8.0	1.0 1.0	13.0 10.0	2.5 1.5	12.0 9.0	ns	2-5
t <sub>PZL</sub>	Output Enable Time OE to O <sub>n</sub>	3.3 5.0	2.5 1.5	6.5 5.0	11.0 8.0	1.0 1.0	13.5 10.0	2.5 1.5	12.0 9.0	ns	2-6
t <sub>PHZ</sub>	Output Disable Time OE to O <sub>n</sub>	3.3 5.0	2.5 1.5	6.5 5.0	10.5 8.0	1.0 1.0	12.0 10.0	2.5 1.5	11.0 8.5	ns	2-5
t <sub>PLZ</sub>	Output Disable Time OE to O <sub>n</sub>	3.3 5.0	2.5 1.5	6.0 4.5	10.5 8.0	1.0 1.0	12.0 10.0	2.5 1.5	11.0 8.5	ns	2-6

\*Voltage Range 3.3 is 3.3V ± 0.3V  
Voltage Range 5.0 is 5.0V ± 0.5V

**AC Operating Requirements:** See Section 2 for Waveforms

Symbol	Parameter	V <sub>CC</sub> * (V)	74AC		54AC	74AC		Units	Fig. No.
			T <sub>A</sub> = +25°C C <sub>L</sub> = 50 pF		T <sub>A</sub> = -55°C to +125°C C <sub>L</sub> = 50 pF	T <sub>A</sub> = -40°C to +85°C C <sub>L</sub> = 50 pF			
			Typ	Guaranteed Minimum					
t <sub>s</sub>	Setup Time, HIGH or LOW D <sub>n</sub> to CP	3.3 5.0	-1.0 -1.0	1.5 1.5	2.5 2.5	1.5 1.5		ns	2-7
t <sub>h</sub>	Hold Time, HIGH or LOW D <sub>n</sub> to CP	3.3 5.0	-1.0 -1.0	3.5 3.5	4.0 4.0	4.0 4.0		ns	2-7
t <sub>w</sub>	CP Pulse Width HIGH or LOW	3.3 5.0	3.5 2.5	5.0 4.0	6.0 5.0	5.5 4.0		ns	2-3

\*Voltage Range 3.3 is 3.3V ± 0.3V  
Voltage Range 5.0 is 5.0V ± 0.5V

**AC Electrical Characteristics:** See Section 2 for Waveforms

Symbol	Parameter	V <sub>CC</sub> * (V)	74ACT			54ACT		74ACT		Units	Fig. No.
			T <sub>A</sub> = +25°C C <sub>L</sub> = 50 pF			T <sub>A</sub> = -55°C to +125°C C <sub>L</sub> = 50 pF		T <sub>A</sub> = -40°C to +85°C C <sub>L</sub> = 50 pF			
			Min	Typ	Max	Min	Max	Min	Max		
t <sub>max</sub>	Maximum Clock Frequency	5.0	120	150		85		110	MHz		
t <sub>PLH</sub>	Propagation Delay CP to O <sub>n</sub>	5.0	2.0	6.0	9.5	1.0	11.5	1.5	10.5	ns	2-3, 4
t <sub>PHL</sub>	Propagation Delay CP to O <sub>n</sub>	5.0	2.5	6.0	9.5	1.0	11.5	2.0	10.5	ns	2-3, 4
t <sub>PZH</sub>	Output Enable Time OE to O <sub>n</sub>	5.0	2.5	7.0	10.5	1.0	12.5	2.0	11.5	ns	2-5
t <sub>PZL</sub>	Output Enable Time OE to O <sub>n</sub>	5.0	2.5	7.0	10.5	1.0	13.0	2.0	12.0	ns	2-6
t <sub>PHZ</sub>	Output Disable Time OE to O <sub>n</sub>	5.0	1.5	7.5	12.0	1.0	13.5	1.0	13.0	ns	2-5
t <sub>PLZ</sub>	Output Disable Time OE to O <sub>n</sub>	5.0	1.5	7.0	10.5	1.0	12.5	1.0	11.5	ns	2-6

\*Voltage Range 5.0 is 5.0V ± 0.5V

**AC Operating Requirements:** See Section 2 for Waveforms

Symbol	Parameter	V <sub>CC</sub> * (V)	74ACT		54ACT	74ACT		Units	Fig. No.
			T <sub>A</sub> = +25°C C <sub>L</sub> = 50 pF		T <sub>A</sub> = -55°C to +125°C C <sub>L</sub> = 50 pF	T <sub>A</sub> = -40°C to +85°C C <sub>L</sub> = 50 pF			
			Typ		Guaranteed Minimum				
t <sub>s</sub>	Setup Time, HIGH or LOW D <sub>n</sub> to CP	5.0	2.5	2.0	4.0	2.5	ns	2-7	
t <sub>h</sub>	Hold Time, HIGH or LOW D <sub>n</sub> to CP	5.0	-0.5	2.0	3.0	2.5	ns	2-7	
t <sub>w</sub>	CP Pulse Width HIGH or LOW	5.0	3.0	4.5	6.0	5.5	ns	2-3	

\*Voltage Range 5.0 is 5.0V ± 0.5V

**Capacitance**

Symbol	Parameter	Typ	Units	Conditions
C <sub>IN</sub>	Input Capacitance	4.5	pF	V <sub>CC</sub> = 5.0V
C <sub>PD</sub>	Power Dissipation Capacitance	35.0	pF	V <sub>CC</sub> = 5.0V