

# EMIFIL® (Inductor type) Chip Ferrite Bead

## BLM18P Series (0603 Size)

### ■ Dimensions

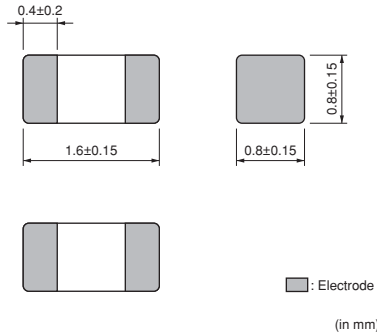

### ■ Equivalent Circuit



### ■ Packaging

Code	Packaging	Minimum Quantity
D	180mm Paper Tape	4000
J	330mm Paper Tape	10000
B	Bulk(Bag)	1000

### ■ Rated Value (□: packaging code)

Part Number	Impedance (at 100MHz/20°C)	Impedance (at 1GHz/20°C)	Rated Current	DC Resistance	Operating Temperature Range
BLM18PG300SN1□	30ohm (Typ.)	-	1000mA	0.05ohm max.	-55 to +125°C
BLM18PG330SN1□	33ohm ±25%	-	3000mA	0.025ohm max.	-55 to +125°C
BLM18PG600SN1□	60ohm (Typ.)	-	500mA	0.10ohm max.	-55 to +125°C
BLM18PG121SN1□	120ohm ±25%	-	2000mA	0.05ohm max.	-55 to +125°C
BLM18PG181SN1□	180ohm ±25%	-	1500mA	0.09ohm max.	-55 to +125°C
BLM18PG221SN1□	220ohm ±25%	-	1400mA	0.10ohm max.	-55 to +125°C
BLM18PG331SN1□	330ohm ±25%	-	1200mA	0.15ohm max.	-55 to +125°C
BLM18PG471SN1□	470ohm ±25%	-	1000mA	0.20ohm max.	-55 to +125°C

Number of Circuits: 1

Continued on the following page.

● This data sheet is applied for CHIP FERRITE BEAD used for General Electronics equipment for your design.

### ⚠ Note:

- This datasheet is downloaded from the website of Murata Manufacturing co., ltd. Therefore, it's specifications are subject to change or our products in it may be discontinued without advance notice. Please check with our sales representatives or product engineers before ordering.
- This datasheet has only typical specifications because there is no space for detailed specifications. Therefore, please approve our product specifications or transact the approval sheet for product specifications before ordering.

Continued from the preceding page.

**Derating of Rated Current**

In operating temperature exceeding +85°C, derating of current is necessary for BLM18PG series. Please apply the derating curve shown in chart according to the operating temperature.

Derating of Rated Current

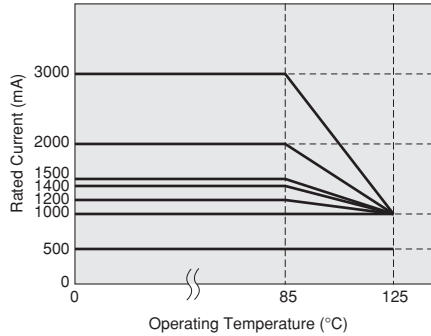

**Impedance-Frequency Characteristics (Main Items)**

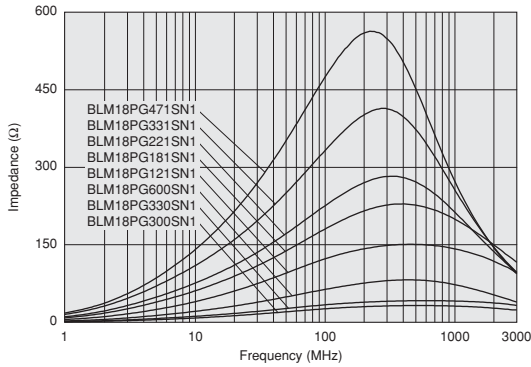

**Impedance-Frequency Characteristics**

**BLM18PG300SN1**

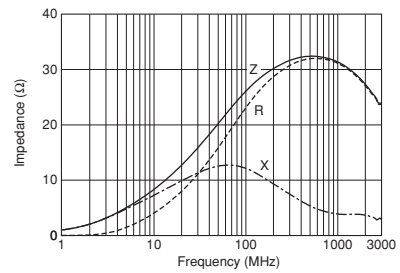

**Impedance-Frequency Characteristics**

**BLM18PG330SN1**

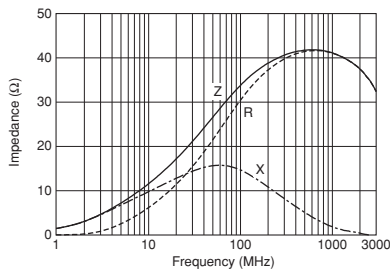

**Impedance-Frequency Characteristics**

**BLM18PG600SN1**

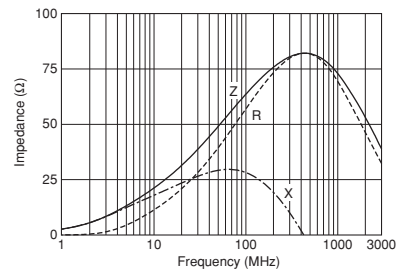

Continued on the following page.

● This data sheet is applied for CHIP FERRITE BEAD used for General Electronics equipment for your design.

**Note:**

1. This datasheet is downloaded from the website of Murata Manufacturing co., ltd. Therefore, it's specifications are subject to change or our products in it may be discontinued without advance notice. Please check with our sales representatives or product engineers before ordering.
2. This datasheet has only typical specifications because there is no space for detailed specifications. Therefore, please approve our product specifications or transact the approval sheet for product specifications before ordering.

Continued from the preceding page.

**Impedance-Frequency Characteristics**  
**BLM18PG121SN1**

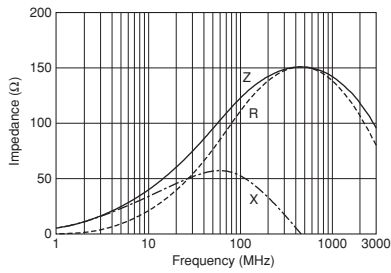

**Impedance-Frequency Characteristics**  
**BLM18PG181SN1**

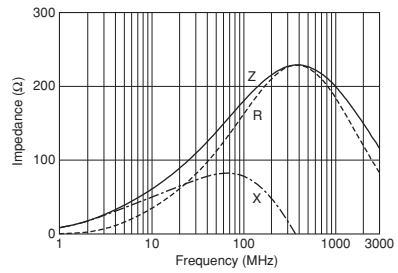

**Impedance-Frequency Characteristics**  
**BLM18PG221SN1**

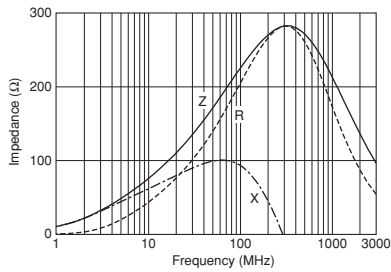

**Impedance-Frequency Characteristics**  
**BLM18PG331SN1**

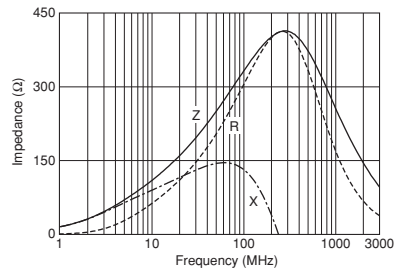

**Impedance-Frequency Characteristics**  
**BLM18PG471SN1**

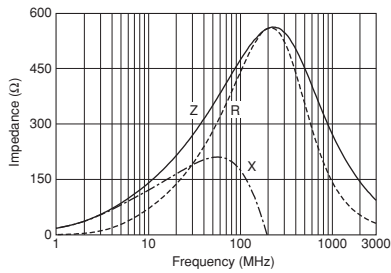

Continued on the following page.

● This data sheet is applied for CHIP FERRITE BEAD used for General Electronics equipment for your design.

**Note:**

1. This datasheet is downloaded from the website of Murata Manufacturing co., ltd. Therefore, it's specifications are subject to change or our products in it may be discontinued without advance notice. Please check with our sales representatives or product engineers before ordering.
2. This datasheet has only typical specifications because there is no space for detailed specifications. Therefore, please approve our product specifications or transact the approval sheet for product specifications before ordering.

 Continued from the preceding page.

### ■ Caution/Notice

#### Caution (Rating)

Do not use products beyond the rated current as this may create excessive heat and deteriorate the insulation resistance.

#### Notice

Solderability of Tin plating termination chip might be deteriorated when low temperature soldering profile where peak solder temperature is below the Tin melting point is used. Please confirm the solderability of Tin plating termination chip before use.

● This data sheet is applied for CHIP FERRITE BEAD used for General Electronics equipment for your design.

#### Note:

1. This datasheet is downloaded from the website of Murata Manufacturing co., ltd. Therefore, it's specifications are subject to change or our products in it may be discontinued without advance notice. Please check with our sales representatives or product engineers before ordering.
2. This datasheet has only typical specifications because there is no space for detailed specifications. Therefore, please approve our product specifications or transact the approval sheet for product specifications before ordering.

# EMIFIL® (Inductor type) Chip Ferrite Bead

## BLM18K Series (0603 Size)

### ■ Dimensions

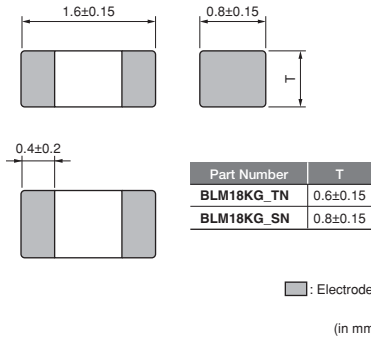

### ■ Equivalent Circuit

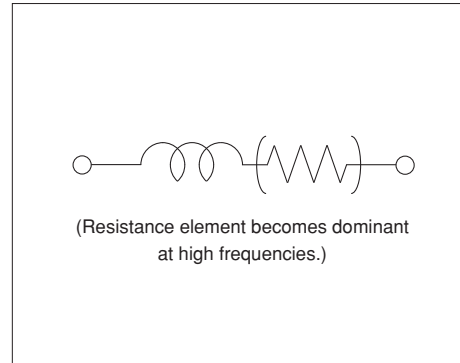

### ■ Packaging

Code	Packaging	Minimum Quantity
D	180mm Paper Tape	4000
J	330mm Paper Tape	10000
B	Bulk(Bag)	1000

### ■ Rated Value (□: packaging code)

Part Number	Impedance (at 100MHz/20°C)	Impedance (at 1GHz/20°C)	Rated Current	DC Resistance	Operating Temperature Range
BLM18KG260TN1□	26ohm ±25%	-	6000mA	0.007ohm max.	-55 to +125°C
BLM18KG300TN1□	30ohm ±25%	-	5000mA	0.010ohm max.	-55 to +125°C
BLM18KG700TN1□	70ohm ±25%	-	3500mA	0.022ohm max.	-55 to +125°C
BLM18KG101TN1□	100ohm ±25%	-	3000mA	0.030ohm max.	-55 to +125°C
BLM18KG121TN1□	120ohm ±25%	-	3000mA	0.030ohm max.	-55 to +125°C
BLM18KG221SN1□	220ohm ±25%	-	2200mA	0.050ohm max.	-55 to +125°C
BLM18KG331SN1□	330ohm ±25%	-	1700mA	0.080ohm max.	-55 to +125°C
BLM18KG471SN1□	470ohm ±25%	-	1500mA	0.130ohm max.	-55 to +125°C
BLM18KG601SN1□	600ohm ±25%	-	1300mA	0.150ohm max.	-55 to +125°C

Number of Circuits: 1

Continued on the following page.

● This data sheet is applied for CHIP FERRITE BEAD used for General Electronics equipment for your design.

### ⚠ Note:

- This datasheet is downloaded from the website of Murata Manufacturing co., ltd. Therefore, it's specifications are subject to change or our products in it may be discontinued without advance notice. Please check with our sales representatives or product engineers before ordering.
- This datasheet has only typical specifications because there is no space for detailed specifications. Therefore, please approve our product specifications or transact the approval sheet for product specifications before ordering.

Continued from the preceding page.

**Derating of Rated Current**

In operating temperature exceeding +85°C, derating of current is necessary for BLM18KG series. Please apply the derating curve shown in chart according to the operating temperature.

Derating of Rated Current

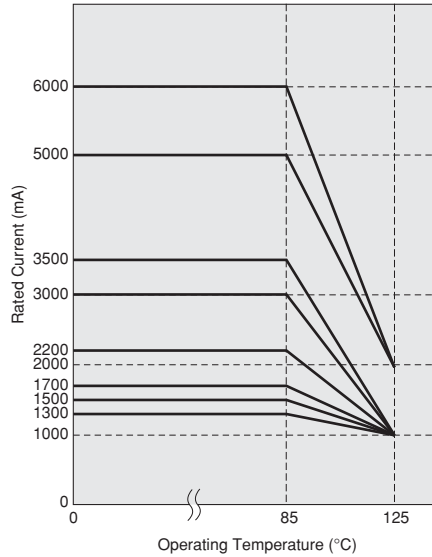

**Impedance-Frequency Characteristics (Main Items)**

**Impedance-Frequency Characteristics BLM18KG260TN1**

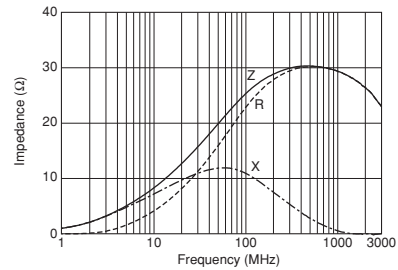
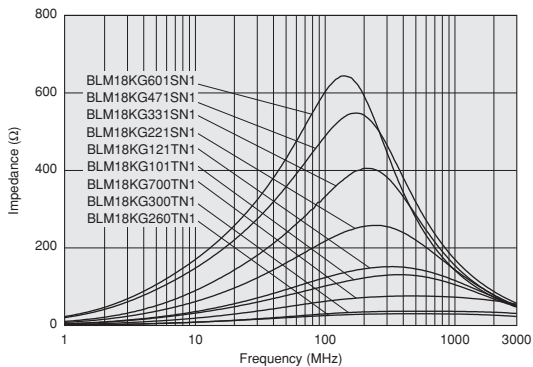

Continued on the following page.

This data sheet is applied for CHIP FERRITE BEAD used for General Electronics equipment for your design.

**Note:**

- This datasheet is downloaded from the website of Murata Manufacturing co., ltd. Therefore, it's specifications are subject to change or our products in it may be discontinued without advance notice. Please check with our sales representatives or product engineers before ordering.
- This datasheet has only typical specifications because there is no space for detailed specifications. Therefore, please approve our product specifications or transact the approval sheet for product specifications before ordering.

Continued from the preceding page.

**Impedance-Frequency Characteristics**  
**BLM18KG300TN1**

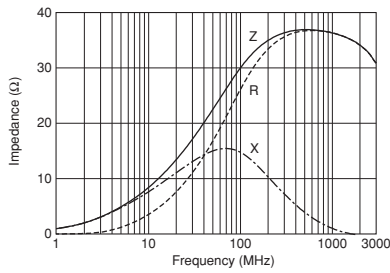

**Impedance-Frequency Characteristics**  
**BLM18KG700TN1**

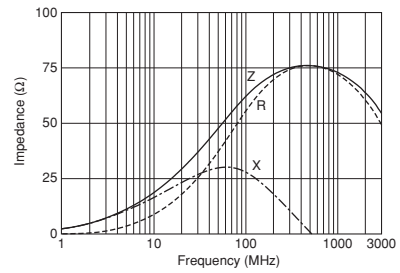

**Impedance-Frequency Characteristics**  
**BLM18KG101TN1**

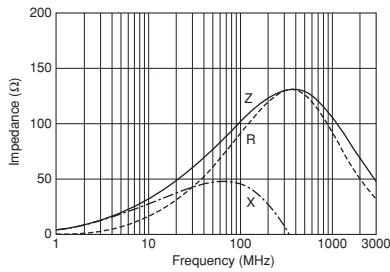

**Impedance-Frequency Characteristics**  
**BLM18KG121TN1**

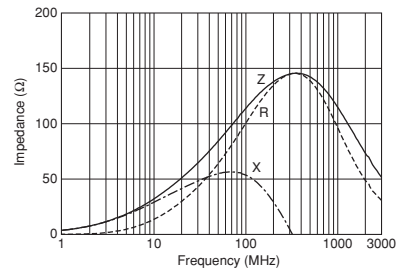

**Impedance-Frequency Characteristics**  
**BLM18KG221SN1**

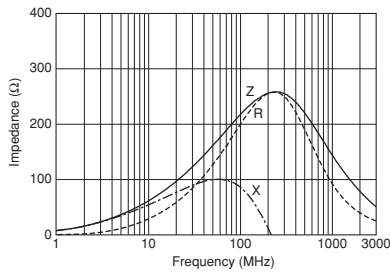

**Impedance-Frequency Characteristics**  
**BLM18KG331SN1**

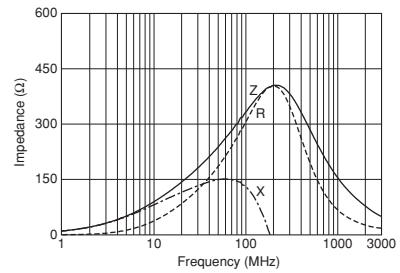

Continued on the following page.

● This data sheet is applied for CHIP FERRITE BEAD used for General Electronics equipment for your design.

**Note:**

1. This datasheet is downloaded from the website of Murata Manufacturing co., ltd. Therefore, it's specifications are subject to change or our products in it may be discontinued without advance notice. Please check with our sales representatives or product engineers before ordering.
2. This datasheet has only typical specifications because there is no space for detailed specifications. Therefore, please approve our product specifications or transact the approval sheet for product specifications before ordering.

Continued from the preceding page.

### ■ Impedance-Frequency Characteristics

#### BLM18KG471SN1

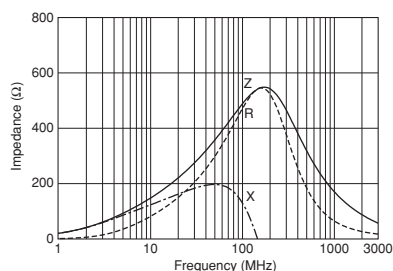

### ■ Impedance-Frequency Characteristics

#### BLM18KG601SN1

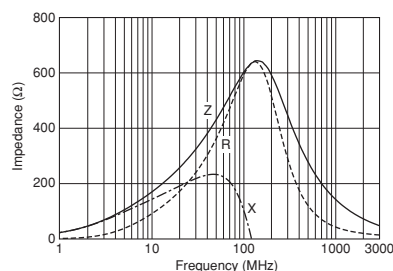

### ■ ⚠ Caution/Notice

#### ⚠ Caution (Rating)

Do not use products beyond the rated current as this may create excessive heat and deteriorate the insulation resistance.

#### Notice

Solderability of Tin plating termination chip might be deteriorated when low temperature soldering profile where peak solder temperature is below the Tin melting point is used. Please confirm the solderability of Tin plating termination chip before use.

● This data sheet is applied for CHIP FERRITE BEAD used for General Electronics equipment for your design.

#### ⚠ Note:

1. This datasheet is downloaded from the website of Murata Manufacturing co., ltd. Therefore, it's specifications are subject to change or our products in it may be discontinued without advance notice. Please check with our sales representatives or product engineers before ordering.
2. This datasheet has only typical specifications because there is no space for detailed specifications. Therefore, please approve our product specifications or transact the approval sheet for product specifications before ordering.



# EMIFIL® (Inductor type) Chip Ferrite Bead for GHz Noise

## BLM18E Series (0603 Size)

### ■ Dimensions

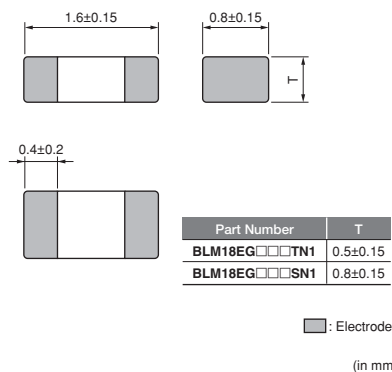

### ■ Equivalent Circuit

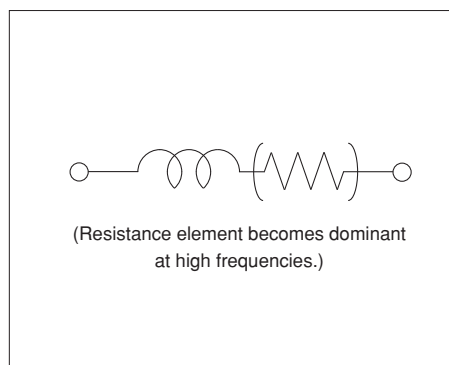

### ■ Packaging

Code	Packaging	Minimum Quantity
D	180mm Paper Tape	4000
J	330mm Paper Tape	10000
B	Bulk(Bag)	1000

### ■ Rated Value (□: packaging code)

Part Number	Impedance (at 100MHz/20°C)	Impedance (at 1GHz/20°C)	Rated Current	DC Resistance	Operating Temperature Range
BLM18EG101TN1□	100ohm ±25%	140ohm (Typ.)	2000mA	0.045ohm max.	-55 to +125°C
BLM18EG121SN1□	120ohm ±25%	145ohm (Typ.)	2000mA	0.04ohm max.	-55 to +125°C
BLM18EG221SN1□	220ohm ±25%	260ohm (Typ.)	2000mA	0.05ohm max.	-55 to +125°C
BLM18EG221TN1□	220ohm ±25%	300ohm (Typ.)	1000mA	0.15ohm max.	-55 to +125°C
BLM18EG331TN1□	330ohm ±25%	450ohm (Typ.)	500mA	0.21ohm max.	-55 to +125°C
BLM18EG391TN1□	390ohm ±25%	520ohm (Typ.)	500mA	0.3ohm max.	-55 to +125°C
BLM18EG471SN1□	470ohm ±25%	550ohm (Typ.)	500mA	0.21ohm max.	-55 to +125°C
BLM18EG601SN1□	600ohm ±25%	700ohm (Typ.)	500mA	0.35ohm max.	-55 to +125°C

Number of Circuits: 1

Continued on the following page.

● This data sheet is applied for CHIP FERRITE BEAD used for General Electronics equipment for your design.

### ⚠ Note:

- This datasheet is downloaded from the website of Murata Manufacturing co., ltd. Therefore, it's specifications are subject to change or our products in it may be discontinued without advance notice. Please check with our sales representatives or product engineers before ordering.
- This datasheet has only typical specifications because there is no space for detailed specifications. Therefore, please approve our product specifications or transact the approval sheet for product specifications before ordering.

Continued from the preceding page.

**Derating of Rated Current**

In operating temperature exceeding +85°C, derating of current is necessary for BLM18EG series. Please apply the derating curve shown in chart according to the operating temperature.

Derating of Rated Current

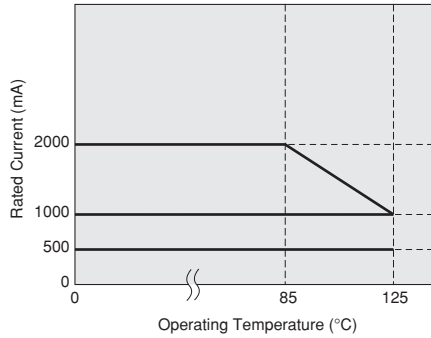

**Impedance-Frequency Characteristics (Main Items) BLM18EG\_TN1 Series**

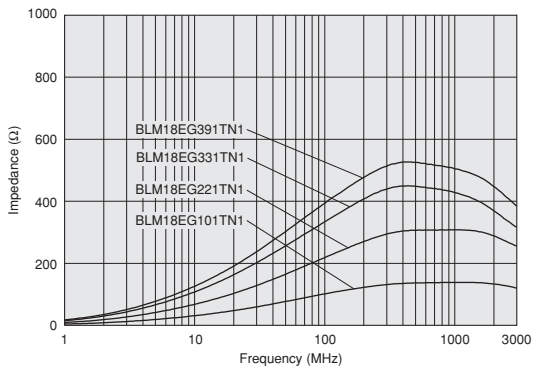

**Impedance-Frequency Characteristics (Main Items) BLM18EG\_SN1 Series**

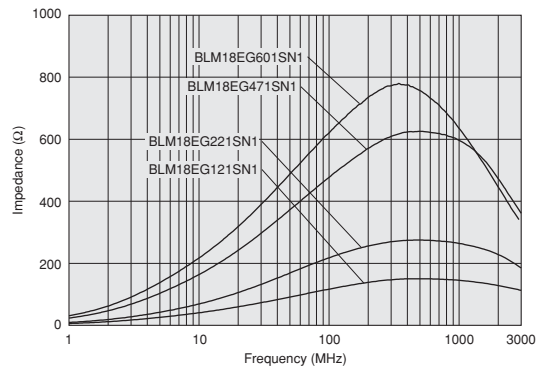

**Impedance-Frequency Characteristics BLM18EG101TN1**

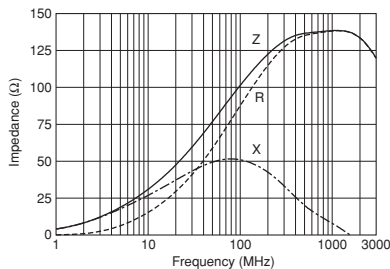

**Impedance-Frequency Characteristics BLM18EG121SN1**

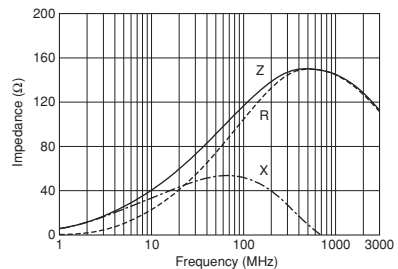

Continued on the following page.

This data sheet is applied for CHIP FERRITE BEAD used for General Electronics equipment for your design.

**Note:**

- This datasheet is downloaded from the website of Murata Manufacturing co., ltd. Therefore, it's specifications are subject to change or our products in it may be discontinued without advance notice. Please check with our sales representatives or product engineers before ordering.
- This datasheet has only typical specifications because there is no space for detailed specifications. Therefore, please approve our product specifications or transact the approval sheet for product specifications before ordering.

Continued from the preceding page.

**Impedance-Frequency Characteristics**  
**BLM18EG221SN1**

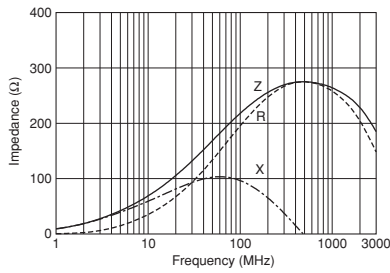

**Impedance-Frequency Characteristics**  
**BLM18EG221TN1**

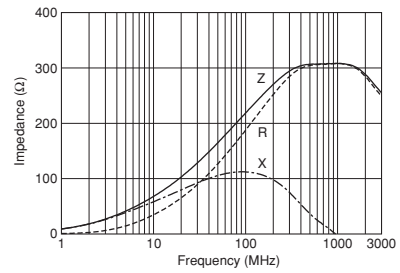

**Impedance-Frequency Characteristics**  
**BLM18EG331TN1**

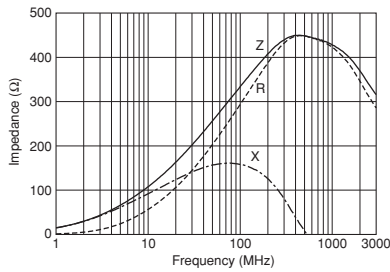

**Impedance-Frequency Characteristics**  
**BLM18EG391TN1**

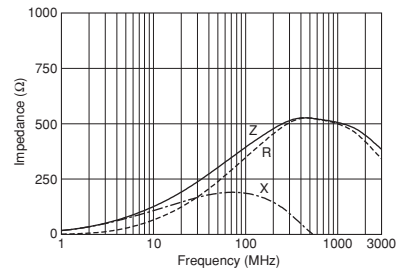

**Impedance-Frequency Characteristics**  
**BLM18EG471SN1**

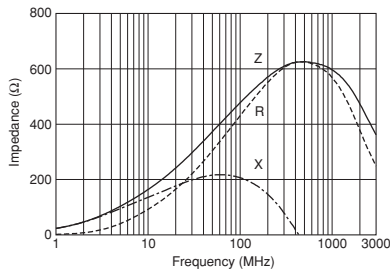

**Impedance-Frequency Characteristics**  
**BLM18EG601SN1**

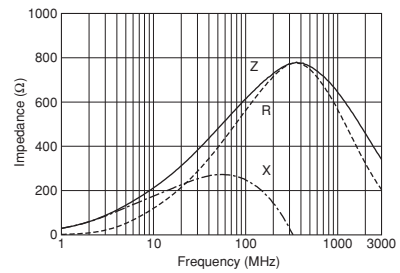

Continued on the following page.

● This data sheet is applied for CHIP FERRITE BEAD used for General Electronics equipment for your design.

**Note:**

1. This datasheet is downloaded from the website of Murata Manufacturing co., ltd. Therefore, it's specifications are subject to change or our products in it may be discontinued without advance notice. Please check with our sales representatives or product engineers before ordering.
2. This datasheet has only typical specifications because there is no space for detailed specifications. Therefore, please approve our product specifications or transact the approval sheet for product specifications before ordering.

 Continued from the preceding page.

### ■ Caution/Notice

#### Caution (Rating)

Do not use products beyond the rated current as this may create excessive heat and deteriorate the insulation resistance.

#### Notice

Solderability of Tin plating termination chip might be deteriorated when low temperature soldering profile where peak solder temperature is below the Tin melting point is used. Please confirm the solderability of Tin plating termination chip before use.

● This data sheet is applied for CHIP FERRITE BEAD used for General Electronics equipment for your design.

#### Note:

1. This datasheet is downloaded from the website of Murata Manufacturing co., ltd. Therefore, it's specifications are subject to change or our products in it may be discontinued without advance notice. Please check with our sales representatives or product engineers before ordering.
2. This datasheet has only typical specifications because there is no space for detailed specifications. Therefore, please approve our product specifications or transact the approval sheet for product specifications before ordering.

# EMIFIL® (Capacitor type) Single Circuit Type for Large Current

## NFM18PS Series (0603 Size)

### ■ Dimensions

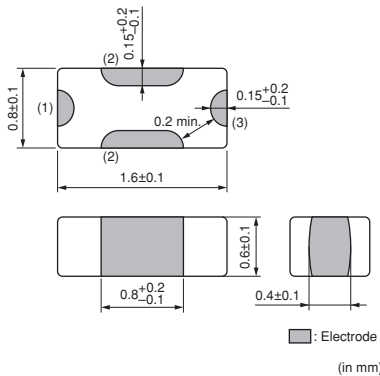

### ■ Insertion Loss Characteristics (Main Items)

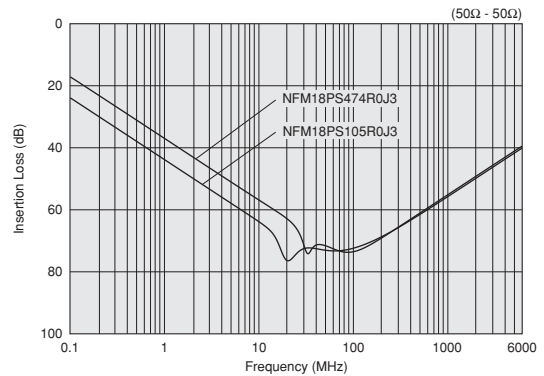

### ■ Equivalent Circuit

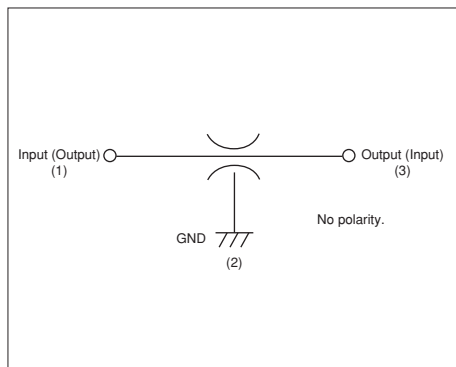

### ■ Packaging

Code	Packaging	Minimum Quantity
D	180mm Paper Tape	4000
B	Bulk(Bag)	500

### ■ Rated Value (□: packaging code)

Part Number	Capacitance	Rated Current	Rated Voltage	Insulation Resistance (min.)	Operating Temperature Range
NFM18PS474R0J3□	0.47μF ±20%	2A	6.3Vdc	1000M ohm	-55 to +125°C
NFM18PS105R0J3□	1.0μF ±20%	2A	6.3Vdc	500M ohm	-55 to +105°C

Number of Circuit: 1

### ■ ⚠ Caution/Notice

#### ⚠ Caution (Rating)

Do not use products beyond the rated current and rated voltage as this may create excessive heat and deteriorate the insulation resistance.

#### Notice

Solderability of Tin plating termination chip might be deteriorated when low temperature soldering profile where peak solder temperature is below the Tin melting point is used. Please confirm the solderability of Tin plating termination chip before use.

● This data sheet is applied for CHIP EMIFIL® used for General Electronics equipment for your design.

#### ⚠ Note:

- This datasheet is downloaded from the website of Murata Manufacturing co., ltd. Therefore, it's specifications are subject to change or our products in it may be discontinued without advance notice. Please check with our sales representatives or product engineers before ordering.
- This datasheet has only typical specifications because there is no space for detailed specifications. Therefore, please approve our product specifications or transact the approval sheet for product specifications before ordering.

# EMIFIL® (Capacitor type) Single Circuit Type for Large Current

## NFM18PC Series (0603 Size)

### ■ Dimensions

NFM18PC (0.1 to 0.47μF, 2.2μF - 6.3V)

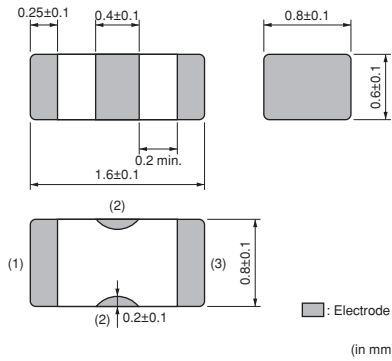

### ■ Dimensions

NFM18PC (1μF, 2.2μF - 10V)

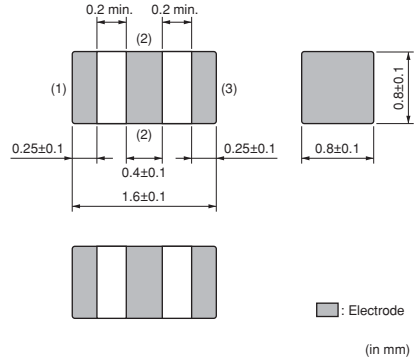

### ■ Insertion Loss Characteristics (Main Items)

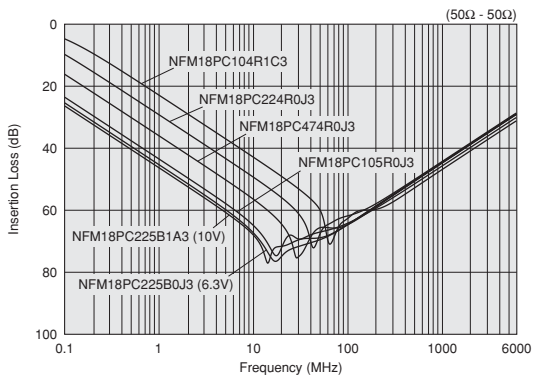

### ■ Equivalent Circuit

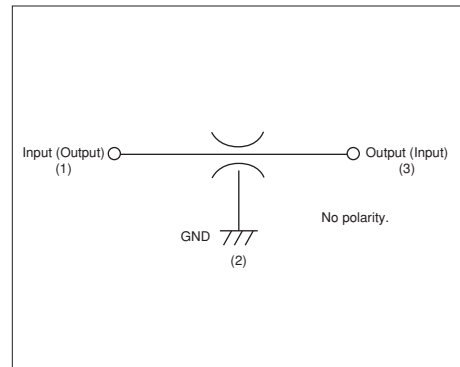

### ■ Packaging

Code	Packaging	Minimum Quantity
D	180mm Paper Tape	4000
B	Bulk(Bag)	500

### ■ Rated Value (□: packaging code)

Part Number	Capacitance	Rated Current	Rated Voltage	Insulation Resistance (min.)	Operating Temperature Range
NFM18PC104R1C3□	0.1μF ±20%	2A	16Vdc	1000M ohm	-55 to +125°C
NFM18PC224R0J3□	0.22μF ±20%	2A	6.3Vdc	1000M ohm	-55 to +125°C
NFM18PC474R0J3□	0.47μF ±20%	2A	6.3Vdc	1000M ohm	-55 to +125°C
NFM18PC105R0J3□	1.0μF ±20%	4A	6.3Vdc	500M ohm	-55 to +105°C
NFM18PC225B0J3□	2.2μF ±20%	2A	6.3Vdc	200M ohm	-40 to +85°C
NFM18PC225B1A3□	2.2μF ±20%	4A	10Vdc	200M ohm	-40 to +85°C

Number of Circuit: 1

Continued on the following page.

● This data sheet is applied for CHIP EMIFIL® used for General Electronics equipment for your design.

### ⚠ Note:

- This datasheet is downloaded from the website of Murata Manufacturing co., ltd. Therefore, it's specifications are subject to change or our products in it may be discontinued without advance notice. Please check with our sales representatives or product engineers before ordering.
- This datasheet has only typical specifications because there is no space for detailed specifications. Therefore, please approve our product specifications or transact the approval sheet for product specifications before ordering.

 Continued from the preceding page.

### ■ Caution/Notice

#### Caution (Rating)

Do not use products beyond the rated current and rated voltage as this may create excessive heat and deteriorate the insulation resistance.

#### Notice

Solderability of Tin plating termination chip might be deteriorated when low temperature soldering profile where peak solder temperature is below the Tin melting point is used. Please confirm the solderability of Tin plating termination chip before use.

● This data sheet is applied for CHIP EMIFIL® used for General Electronics equipment for your design.

#### Note:

1. This datasheet is downloaded from the website of Murata Manufacturing co., ltd. Therefore, it's specifications are subject to change or our products in it may be discontinued without advance notice. Please check with our sales representatives or product engineers before ordering.
2. This datasheet has only typical specifications because there is no space for detailed specifications. Therefore, please approve our product specifications or transact the approval sheet for product specifications before ordering.

# Common Mode Choke Coil Wire Wound Type for Large Current

## DLW5AH/DLW5BS Series (2014/2020 Size)

### ■ Dimensions

#### DLW5AH Series

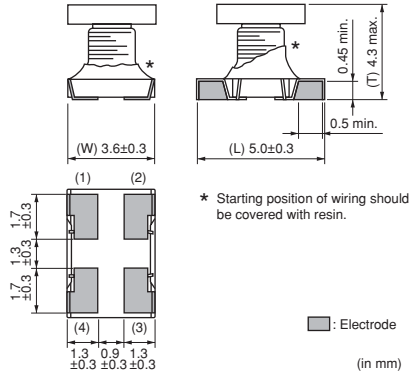

### ■ Dimensions

#### DLW5BS Series

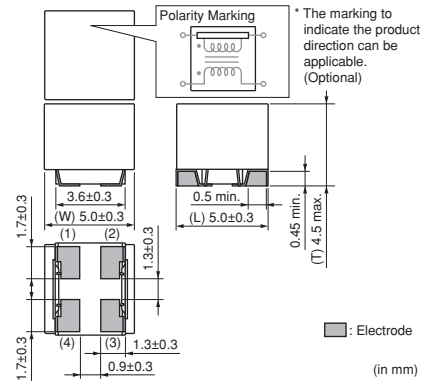

### ■ Impedance-Frequency Characteristics (Main Items)

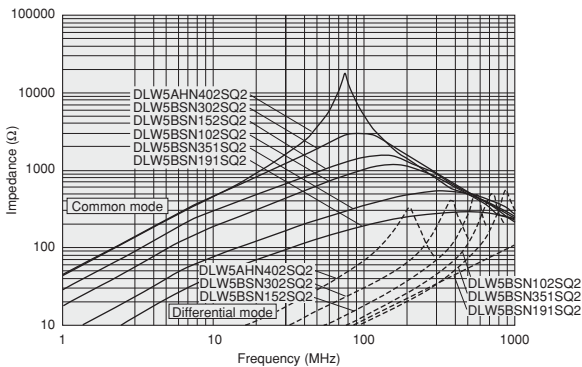

### ■ Equivalent Circuit

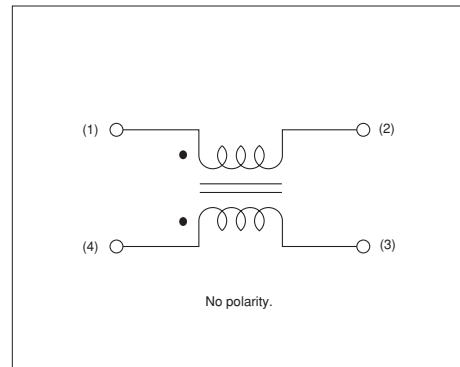

### ■ Packaging

Code	Packaging	Minimum Quantity
L	180mm Embossed Tape	400
K	330mm Embossed Tape	1500
B	Bulk(Bag)	100

### ■ Rated Value (□: packaging code)

Part Number	Common Mode Impedance (at 100MHz/20°C)	Rated Current	Rated Voltage	Insulation Resistance (min.)	Withstand Voltage	DC Resistance	Operating Temperature Range
DLW5AHN402SQ2□	4000ohm (Typ.)	200mA	50Vdc	10M ohm	125Vdc	3.0ohm max.	-25 to +85°C
DLW5BSN191SQ2□	190ohm (Typ.)	5000mA	50Vdc	10M ohm	125Vdc	0.02ohm max.	-40 to +85°C
DLW5BSN351SQ2□	350ohm (Typ.)	2000mA	50Vdc	10M ohm	125Vdc	0.04ohm max.	-40 to +85°C
DLW5BSN102SQ2□	1000ohm (Typ.)	1500mA	50Vdc	10M ohm	125Vdc	0.06ohm max.	-40 to +85°C
DLW5BSN152SQ2□	1500ohm (Typ.)	1000mA	50Vdc	10M ohm	125Vdc	0.1ohm max.	-40 to +85°C
DLW5BSN302SQ2□	3000ohm (Typ.)	500mA	50Vdc	10M ohm	125Vdc	0.3ohm max.	-40 to +85°C

Number of Circuit: 1

Continued on the following page.

● This data sheet is applied for CHIP COMMON MODE CHOKE COIL used for General Electronics equipment for your design.

#### ⚠ Note:

- This datasheet is downloaded from the website of Murata Manufacturing co., ltd. Therefore, it's specifications are subject to change or our products in it may be discontinued without advance notice. Please check with our sales representatives or product engineers before ordering.
- This datasheet has only typical specifications because there is no space for detailed specifications. Therefore, please approve our product specifications or transact the approval sheet for product specifications before ordering.



 Continued from the preceding page.

## Derating of Rated Current

In operating temperature exceeding  $+75^{\circ}\text{C}$ , derating of current is necessary for DLW5BSN191SQ2 series. Please apply the derating curve shown in chart according to the operating temperature.

Derating of Rated Current

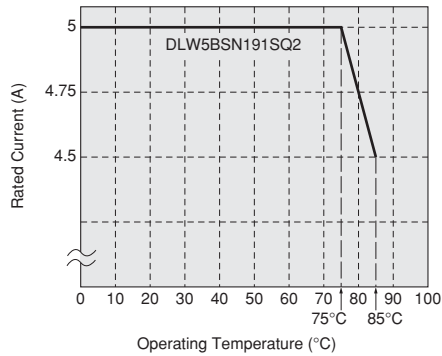

## Caution/Notice

### Caution (Rating)

Do not use products beyond the rated current and rated voltage as this may create excessive heat and deteriorate the insulation resistance.

### Notice

Solderability of Tin plating termination chip might be deteriorated when low temperature soldering profile where peak solder temperature is below the Tin melting point is used. Please confirm the solderability of Tin plating termination chip before use.

● This data sheet is applied for CHIP COMMON MODE CHOKE COIL used for General Electronics equipment for your design.

### Note:

1. This datasheet is downloaded from the website of Murata Manufacturing co., ltd. Therefore, it's specifications are subject to change or our products in it may be discontinued without advance notice. Please check with our sales representatives or product engineers before ordering.
2. This datasheet has only typical specifications because there is no space for detailed specifications. Therefore, please approve our product specifications or transact the approval sheet for product specifications before ordering.

# Common Mode Choke Coil Wire Wound Type for Large Current

## DLW5AT Series (2014 Size)

### ■ Dimensions

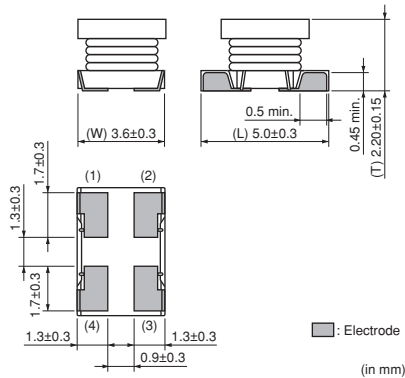

### ■ Impedance-Frequency Characteristics (Main Items)

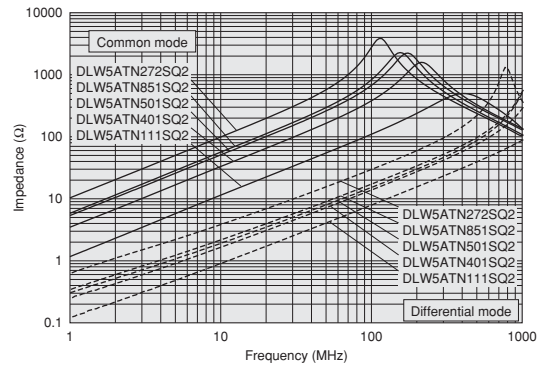

### ■ Equivalent Circuit

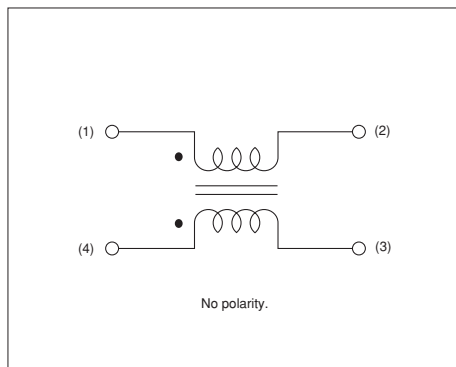

### ■ Packaging

Code	Packaging	Minimum Quantity
L	180mm Embossed Tape	700
K	330mm Embossed Tape	2500
B	Bulk(Bag)	100

### ■ Rated Value (□: packaging code)

Part Number	Common Mode Impedance (at 100MHz/20°C)	Rated Current	Rated Voltage	Insulation Resistance (min.)	Withstand Voltage	DC Resistance	Operating Temperature Range
DLW5ATN111SQ2□	110ohm (Typ.)	5.0A	50Vdc	10M ohm	125Vdc	0.014ohm±40%	-40 to +85°C
DLW5ATN401SQ2□	400ohm (Typ.)	2.0A	50Vdc	10M ohm	125Vdc	0.024ohm±40%	-40 to +85°C
DLW5ATN501SQ2□	500ohm (Typ.)	1.5A	50Vdc	10M ohm	125Vdc	0.040ohm±40%	-40 to +85°C
DLW5ATN851SQ2□	850ohm (Typ.)	1.5A	50Vdc	10M ohm	125Vdc	0.052ohm±40%	-40 to +85°C
DLW5ATN272SQ2□	2700ohm (Typ.)	1.0A	50Vdc	10M ohm	125Vdc	0.080ohm±40%	-40 to +85°C

Number of Circuit: 1

Continued on the following page.

● This data sheet is applied for CHIP COMMON MODE CHOKE COIL used for General Electronics equipment for your design.

#### ⚠ Note:

- This datasheet is downloaded from the website of Murata Manufacturing co., Ltd. Therefore, it's specifications are subject to change or our products in it may be discontinued without advance notice. Please check with our sales representatives or product engineers before ordering.
- This datasheet has only typical specifications because there is no space for detailed specifications. Therefore, please approve our product specifications or transact the approval sheet for product specifications before ordering.

 Continued from the preceding page.

## Derating of Rated Current

In operating temperature exceeding +60°C, derating of current is necessary for DLW5AT series. Please apply the derating curve shown in chart according to the operating temperature.

Derating of Rated Current

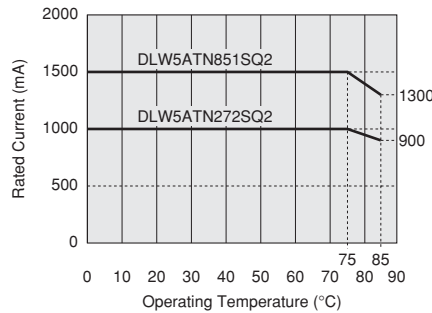
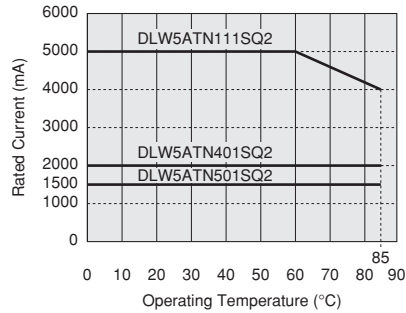

## Caution/Notice

### Caution (Rating)

Do not use products beyond the rated current and rated voltage as this may create excessive heat and deteriorate the insulation resistance.

### Notice

Solderability of Tin plating termination chip might be deteriorated when low temperature soldering profile where peak solder temperature is below the Tin melting point is used. Please confirm the solderability of Tin plating termination chip before use.

● This data sheet is applied for CHIP COMMON MODE CHOKE COIL used for General Electronics equipment for your design.

### Note:

1. This datasheet is downloaded from the website of Murata Manufacturing co., ltd. Therefore, it's specifications are subject to change or our products in it may be discontinued without advance notice. Please check with our sales representatives or product engineers before ordering.
2. This datasheet has only typical specifications because there is no space for detailed specifications. Therefore, please approve our product specifications or transact the approval sheet for product specifications before ordering.

# Common Mode Choke Coil Wire Wound Type for Large Current

## DLW5BT Series (2020 Size)

### ■ Dimensions

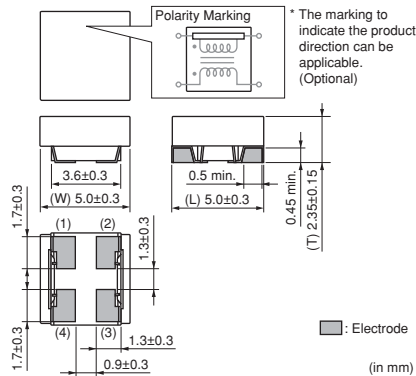

### ■ Impedance-Frequency Characteristics (Main Items)

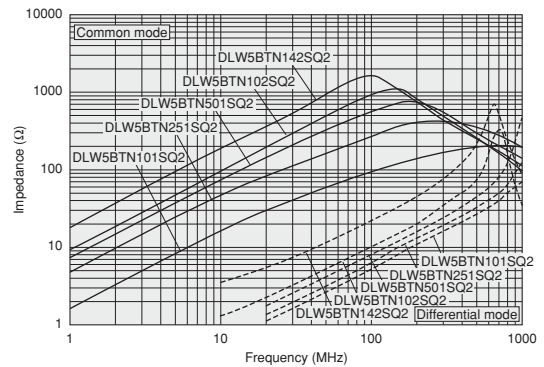

### ■ Equivalent Circuit

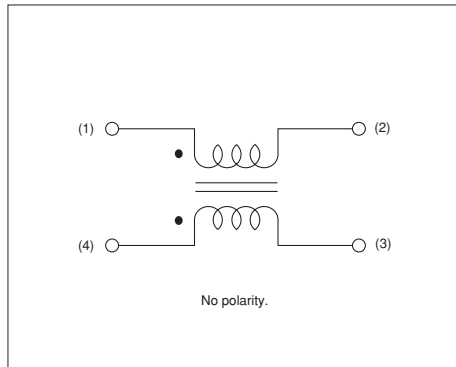

### ■ Packaging

Code	Packaging	Minimum Quantity
L	180mm Embossed Tape	700
K	330mm Embossed Tape	2500
B	Bulk(Bag)	100

### ■ Rated Value (□: packaging code)

Part Number	Common Mode Impedance (at 100MHz/20°C)	Rated Current	Rated Voltage	Insulation Resistance (min.)	Withstand Voltage	DC Resistance	Operating Temperature Range
DLW5BTN101SQ2□	100ohm (Typ.)	6000mA	50Vdc	10M ohm	125Vdc	0.009ohm±40%	-40 to +85°C
DLW5BTN251SQ2□	250ohm (Typ.)	5000mA	50Vdc	10M ohm	125Vdc	0.014ohm±40%	-40 to +85°C
DLW5BTN501SQ2□	500ohm (Typ.)	4000mA	50Vdc	10M ohm	125Vdc	0.019ohm±40%	-40 to +85°C
DLW5BTN102SQ2□	1000ohm (Typ.)	2000mA	50Vdc	10M ohm	125Vdc	0.024ohm±40%	-40 to +85°C
DLW5BTN142SQ2□	1400ohm (Typ.)	1500mA	50Vdc	10M ohm	125Vdc	0.040ohm±40%	-40 to +85°C

Number of Circuit: 1

Continued on the following page.

● This data sheet is applied for CHIP COMMON MODE CHOKE COIL used for General Electronics equipment for your design.

### ⚠ Note:

1. This datasheet is downloaded from the website of Murata Manufacturing co., ltd. Therefore, it's specifications are subject to change or our products in it may be discontinued without advance notice. Please check with our sales representatives or product engineers before ordering.
2. This datasheet has only typical specifications because there is no space for detailed specifications. Therefore, please approve our product specifications or transact the approval sheet for product specifications before ordering.

 Continued from the preceding page.

## Derating of Rated Current

In operating temperature exceeding +60°C, derating of current is necessary for the following part name of DLW5BT series. Please apply the derating curve shown in chart according to the operating temperature.

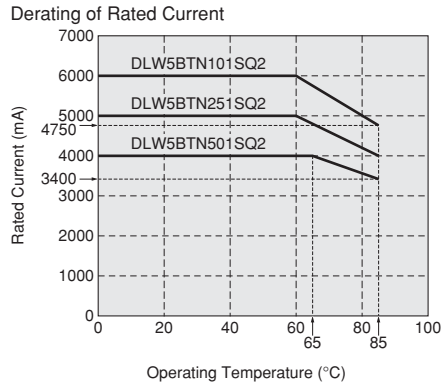

## Caution/Notice

### Caution (Rating)

Do not use products beyond the rated current and rated voltage as this may create excessive heat and deteriorate the insulation resistance.

### Notice

Solderability of Tin plating termination chip might be deteriorated when low temperature soldering profile where peak solder temperature is below the Tin melting point is used. Please confirm the solderability of Tin plating termination chip before use.

● This data sheet is applied for CHIP COMMON MODE CHOKE COIL used for General Electronics equipment for your design.

### Note:

1. This datasheet is downloaded from the website of Murata Manufacturing co., ltd. Therefore, it's specifications are subject to change or our products in it may be discontinued without advance notice. Please check with our sales representatives or product engineers before ordering.
2. This datasheet has only typical specifications because there is no space for detailed specifications. Therefore, please approve our product specifications or transact the approval sheet for product specifications before ordering.