

LQW18AS10NG0C#

“#” indicates a package specification code.

Air-core inductor with non-magnetic electrode material which does not disturb magnetic field in magnetic field utilized application such as MRI.



< List of part numbers with package codes >

LQW18AS10NG0CB LQW18AS10NG0CJ LQW18AS10NG0CD

Appearance & Shape

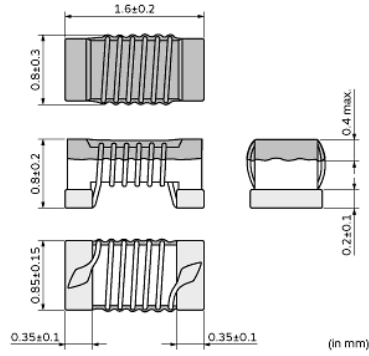
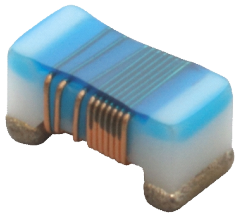

References

Packaging	Specifications	Minimum Order Quantity
B	Bulk(Bag)	500
J	330mm Paper Tape	10000
D	180mm Paper Tape	4000

Mass (typ.)	
1 piece	0.003g

Attention

1.This datasheet is downloaded from the website of Murata Manufacturing Co., Ltd. Therefore, it's specifications are subject to change or our products in it may be discontinued without advance notice. Please check with our sales representatives or product engineers before ordering.

2.This datasheet has only typical specifications because there is no space for detailed specifications.

Therefore, please review our product specifications or consult the approval sheet for product specifications before ordering.

LQW18AS10NG0C#

“#” indicates a package specification code.

Specifications

L size	1.6±0.2mm
W size	0.8±0.3mm
T size	0.8±0.2mm
Size code inch (mm)	0603 (1608)
Inductance	10nH±2%
Inductance Test Frequency	250MHz
Rated current (Itemp) (Based on Temperature rise)	700mA
Max. of DC resistance	0.13Ω
Operating Temperature Range (Self-temperature rise is included)	-40°C to 85°C
Q(min.)	31
Q Test Frequency	250MHz
Self resonance frequency (min.)	4800MHz
Series	LQW18AS_0C

Attention

1.This datasheet is downloaded from the website of Murata Manufacturing Co., Ltd. Therefore, it's specifications are subject to change or our products in it may be discontinued without advance notice. Please check with our sales representatives or product engineers before ordering.

2.This datasheet has only typical specifications because there is no space for detailed specifications.

Therefore, please review our product specifications or consult the approval sheet for product specifications before ordering.

LQW18AS10NG0C#

“#” indicates a package specification code.

Characteristic Data

The charts below may show another part number which shares its characteristics.

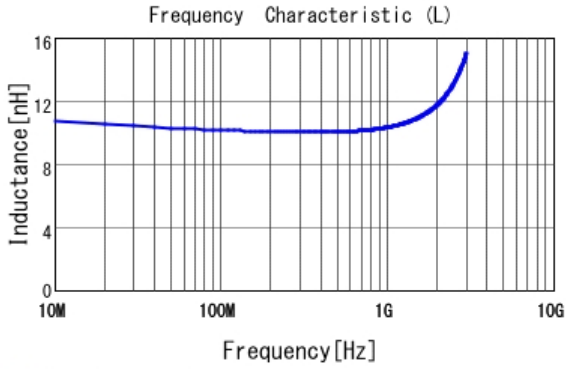

■ LQW18AS10NG0C L

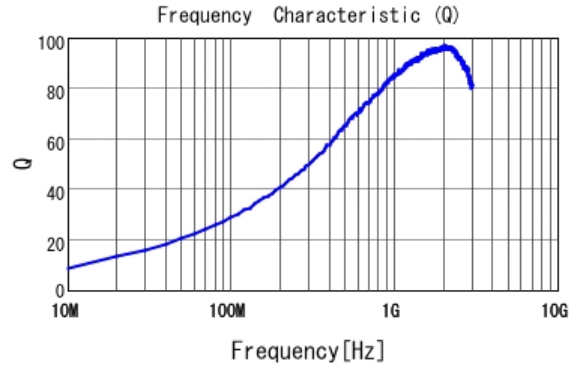

■ LQW18AS10NG0C Q

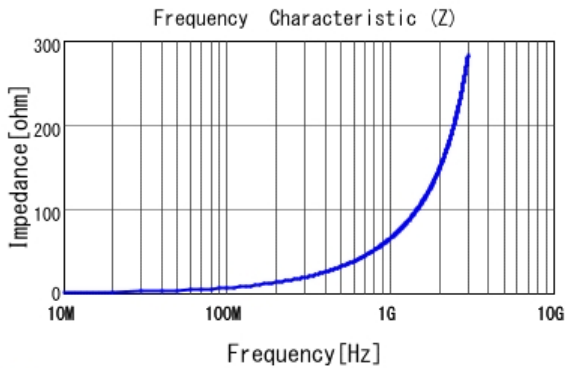

■ LQW18AS10NG0C |Z|

Attention

- 1.This datasheet is downloaded from the website of Murata Manufacturing Co., Ltd. Therefore, it's specifications are subject to change or our products in it may be discontinued without advance notice. Please check with our sales representatives or product engineers before ordering.
- 2.This datasheet has only typical specifications because there is no space for detailed specifications.
Therefore, please review our product specifications or consult the approval sheet for product specifications before ordering.