

NFL18ZT507H1A3#

“#” indicates a package specification code.



< List of part numbers with package codes >

NFL18ZT507H1A3D NFL18ZT507H1A3B

Appearance & Shape

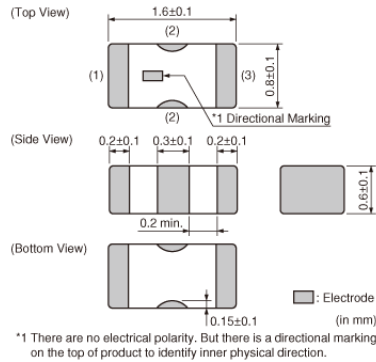

Features

Features (NFL18ST_H/NFL18ZT series)

1. This product is compact size EMI suppression filter of 1.6x0.8x0.6mm. It has steep and deep insertion loss characteristics with T-type circuit.
2. This product has large insertion loss in wide frequency range, results to good noise suppression effect.
3. Sharp insertion loss curve enables both high noise suppression effect and low damage to signal waveform.
4. There are 6 line up of cutoff frequency between 50MHz to 500MHz.

Applications

Automotive Usage	Infotainment
------------------	--------------

Packaging Information

Packaging	Specifications	Minimum Order Quantity
D	180mm Paper Tape	4000
B	Bulk(Bag)	1000

Attention

1. This datasheet is downloaded from the website of Murata Manufacturing Co., Ltd. Therefore, it's specifications are subject to change or our products in it may be discontinued without advance notice. Please check with our sales representatives or product engineers before ordering.
2. This datasheet has only typical specifications because there is no space for detailed specifications. Therefore, please review our product specifications or consult the approval sheet for product specifications before ordering.

NFL18ZT507H1A3#

“#” indicates a package specification code.



Specifications

Shape	SMD	Capacitance	10pF
Size Code (in mm)	1608	Inductance	42nH
Size Code (in inch)	0603	Insertion Loss	6dB max.(0 to 500MHz) 30dB min.(1700 to 2000MHz)
Length	1.6mm		
Length Tolerance	±0.1mm		
Width	0.8mm		
Width Tolerance	±0.1mm		
Thickness	0.6mm		
Thickness Tolerance	±0.1mm		
Rated Current	100mA		
Operating Temperature Range	-55°C to 125°C		
Mass(typ.)	0.004g		
Number of Circuit	1		
Rated Voltage	10Vdc		
Withstanding Voltage	30Vdc		
Insulation Resistance(min.)	1000MΩ		
Nominal Cut-off Frequency	500MHz		

Attention

1.This datasheet is downloaded from the website of Murata Manufacturing Co., Ltd. Therefore, it's specifications are subject to change or our products in it may be discontinued without advance notice. Please check with our sales representatives or product engineers before ordering.

2.This datasheet has only typical specifications because there is no space for detailed specifications.

Therefore, please review our product specifications or consult the approval sheet for product specifications before ordering.

NFL18ZT507H1A3#

“#” indicates a package specification code.

Product Data

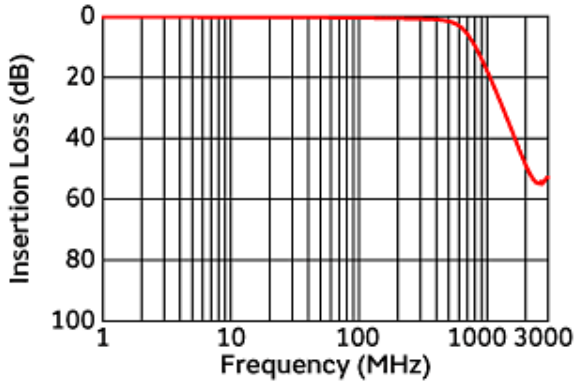

Insertion Loss Characteristics

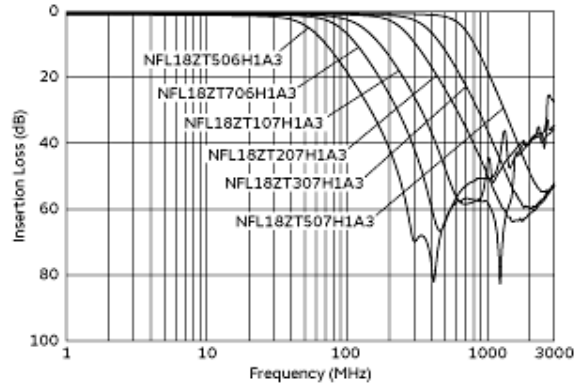

Insertion Loss Characteristics (Main Items)

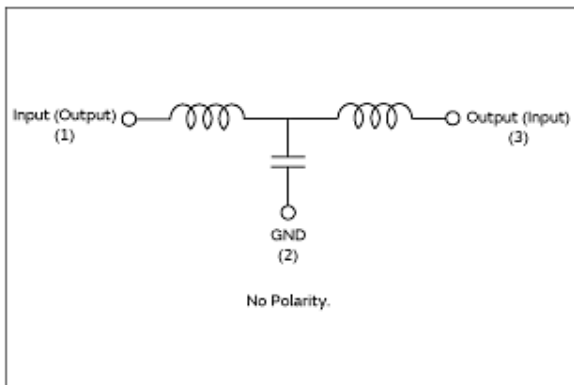

Equivalent Circuit

Attention

- 1.This datasheet is downloaded from the website of Murata Manufacturing Co., Ltd. Therefore, it's specifications are subject to change or our products in it may be discontinued without advance notice. Please check with our sales representatives or product engineers before ordering.
- 2.This datasheet has only typical specifications because there is no space for detailed specifications. Therefore, please review our product specifications or consult the approval sheet for product specifications before ordering.