

LQW15AN4N0C10#

indicates a package specification code.



< List of part numbers with package codes >
 LQW15AN4N0C10D , LQW15AN4N0C10B

Shape

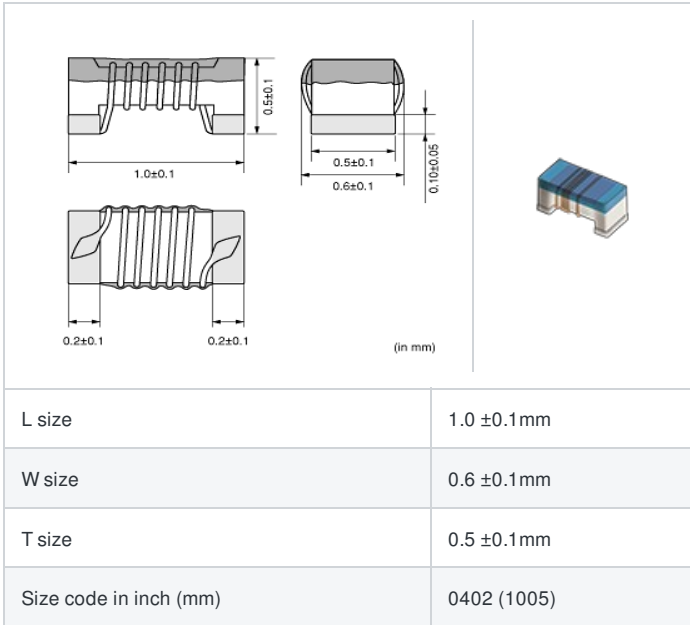

References

Packaging code	Specifications	Minimum quantity
D	φ180mm Paper taping	10000
B	Packing in bulk	500

Mass (Typ.)	
1 piece	0.0008g

Specifications

Inductance	4.0nH ±0.2nH
Inductance test frequency	100MHz
Rated current (Itemp) (Based on Temperature rise)	800mA
Max. of DC resistance	0.051Ω
Q (min.)	30
Q test frequency	250MHz
Self resonance frequency (min.)	6.5GHz
Operating temperature range (Self-temperature rise is not included)	-55~125°C
Series	LQW15AN_10

Attention

- 1.This datasheet is downloaded from the website of Murata Manufacturing Co., Ltd. Therefore, it's specifications are subject to change or our products in it may be discontinued without advance notice. Please check with our sales representatives or product engineers before ordering.
- 2.This datasheet has only typical specifications because there is no space for detailed specifications. Therefore, please review our product specifications or consult the approval sheet for product specifications before ordering.

Chart of characteristic data (The charts below may show another part number which shares its characteristics.)

▪ Inductance-Frequency characteristics (Typ.)

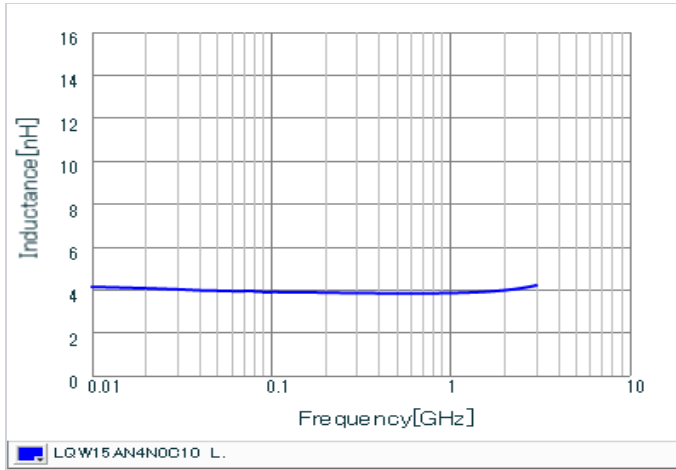

▪ Q-Frequency characteristics (Typ.)

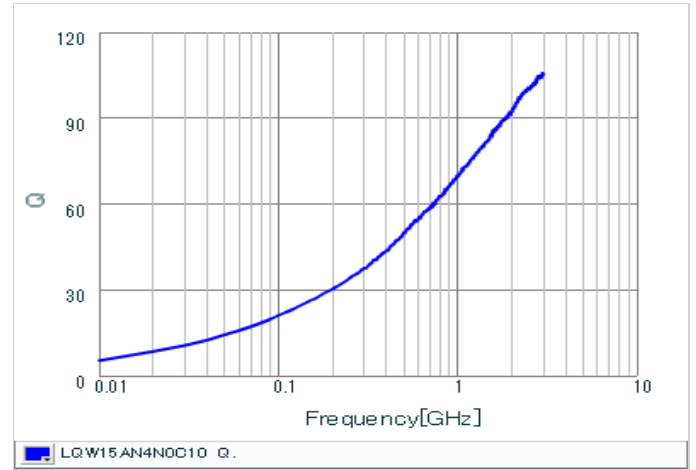

⚠ Attention

- 1.This datasheet is downloaded from the website of Murata Manufacturing Co., Ltd. Therefore, it's specifications are subject to change or our products in it may be discontinued without advance notice. Please check with our sales representatives or product engineers before ordering.
- 2.This datasheet has only typical specifications because there is no space for detailed specifications. Therefore, please review our product specifications or consult the approval sheet for product specifications before ordering.