

GRM188R71H102KA01#

"#" indicates a package specification code.



< List of part numbers with package codes >

GRM188R71H102KA01D , GRM188R71H102KA01J

Shape

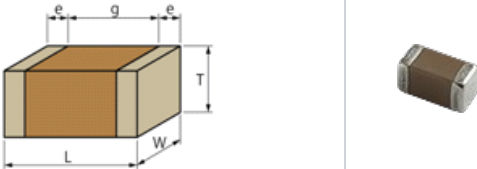

| | |
|---------------------------------------|--------------|
| L size | 1.6 ±0.1mm |
| W size | 0.8 ±0.1mm |
| T size | 0.8 ±0.1mm |
| External terminal width e | 0.2 to 0.5mm |
| Distance between external terminals g | 0.5mm min. |
| Size code in inch(mm) | 0603 (1608M) |

Notes

Please use replacements or Recommended.

References

| Packaging | Specifications | Minimum quantity |
|-----------|---------------------|------------------|
| D | φ180mm Paper taping | 4000 |
| J | φ330mm Paper taping | 10000 |

| Mass (typ.) | |
|-------------|-------|
| 1 piece | 6.3mg |
| φ180mm Reel | 144g |

Specifications

| | |
|--|--------------|
| Capacitance | 1000pF ±10% |
| Rated voltage | 50Vdc |
| Temperature characteristics (complied standard) | X7R(EIA) |
| Capacitance change rate | ±15.0% |
| Temperature range of temperature characteristics | -55 to 125°C |
| Operating temperature range | -55 to 125°C |

Attention

- 1.This datasheet is downloaded from the website of Murata Manufacturing Co., Ltd. Therefore, it's specifications are subject to change or our products in it may be discontinued without advance notice. Please check with our sales representatives or product engineers before ordering.
- 2.This datasheet has only typical specifications because there is no space for detailed specifications. Therefore, please review our product specifications or consult the approval sheet for product specifications before ordering.

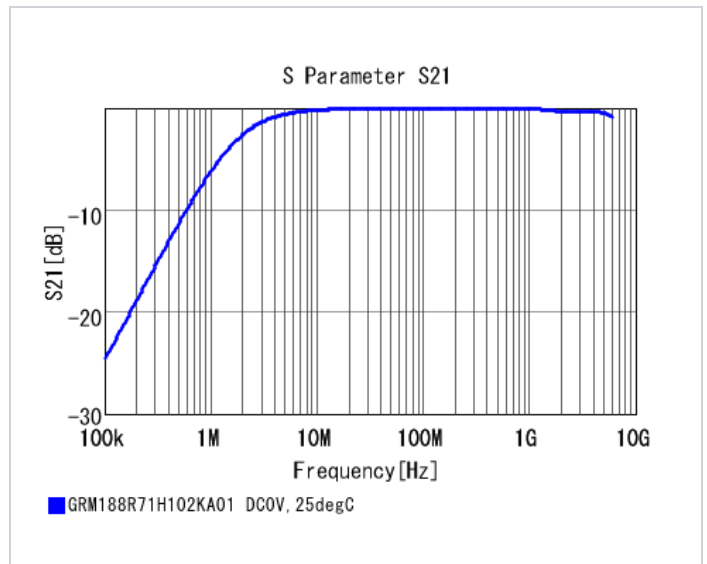
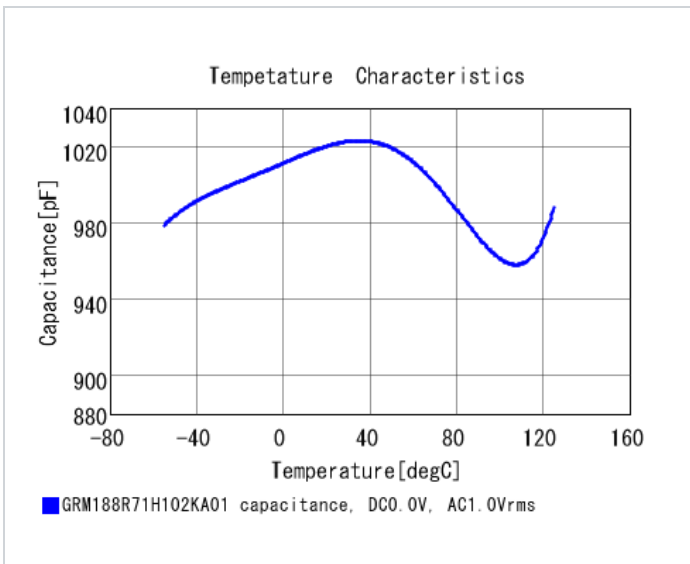
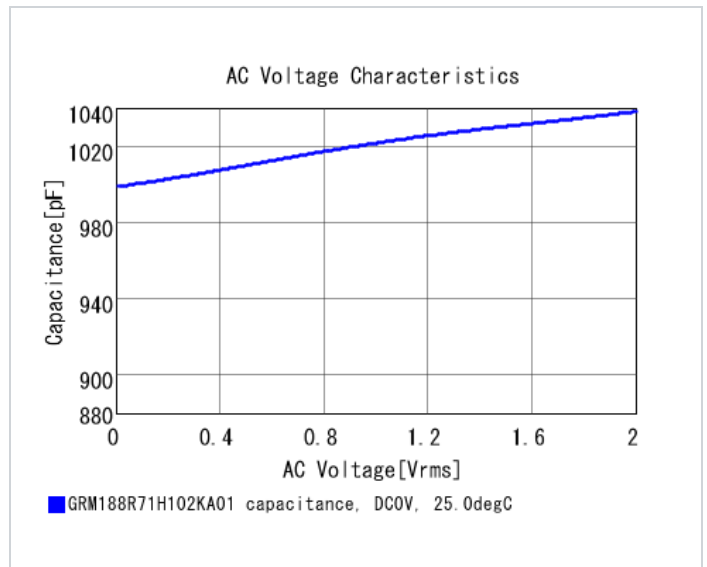
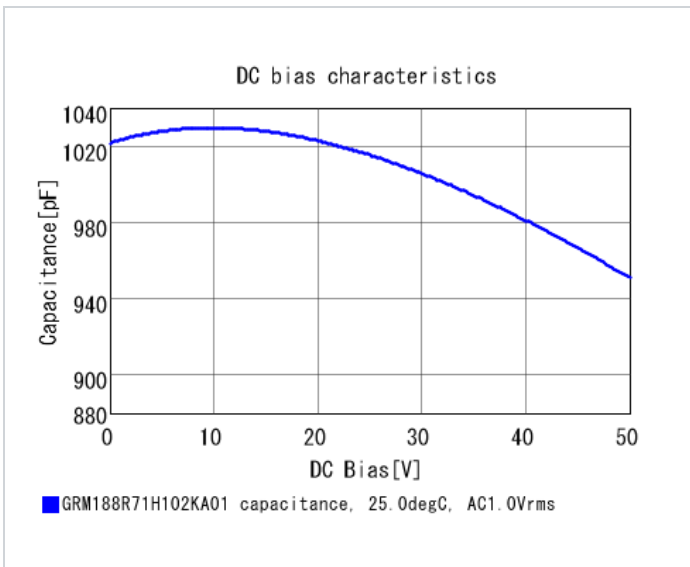
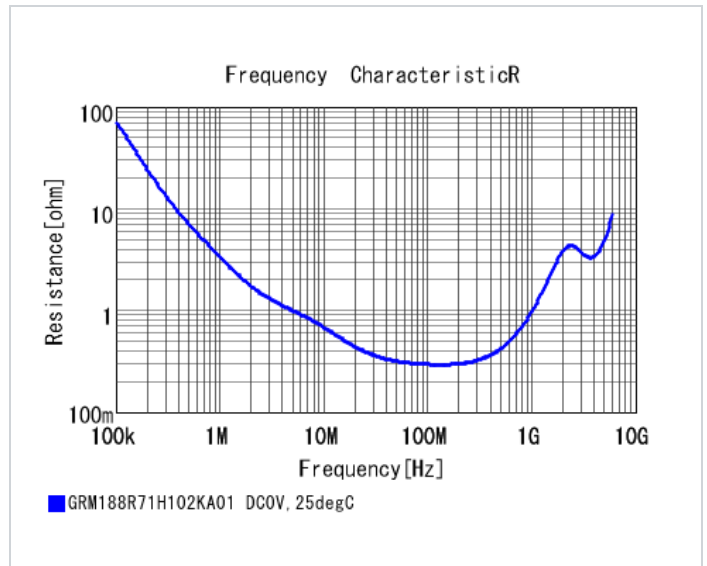
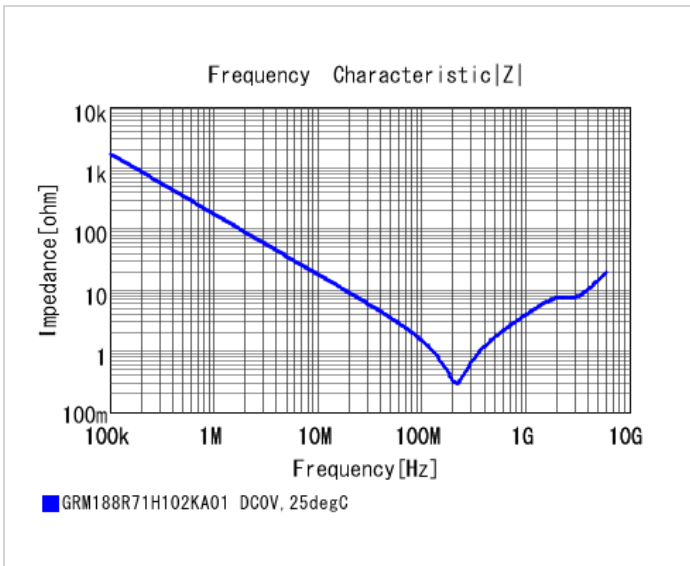

⚠ Attention

- 1.This datasheet is downloaded from the website of Murata Manufacturing Co., Ltd. Therefore, it's specifications are subject to change or our products in it may be discontinued without advance notice. Please check with our sales representatives or product engineers before ordering.
 - 2.This datasheet has only typical specifications because there is no space for detailed specifications.
- Therefore, please review our product specifications or consult the approval sheet for product specifications before ordering.