

LQB15NNR39K10#

indicates a package specification code.



< List of part numbers with package codes >
LQB15NNR39K10D , LQB15NNR39K10B

Shape

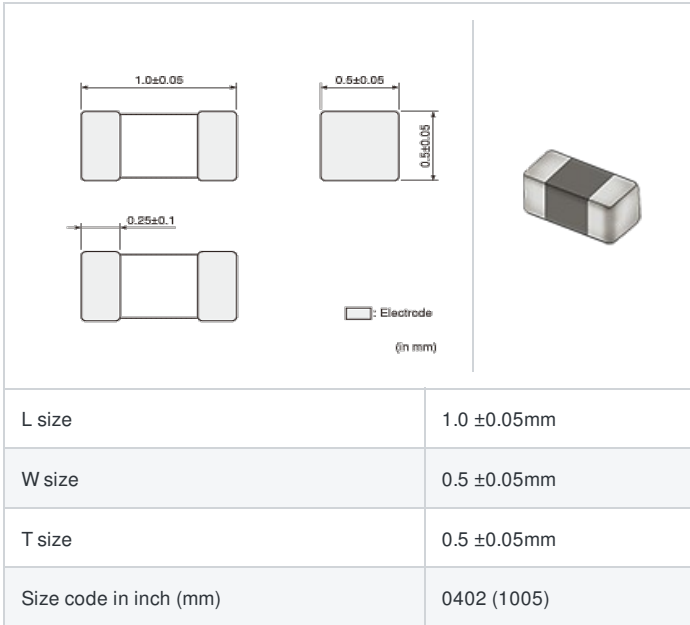

Notes

When rated current is applied to the products, self-generation of heat will rise to 25°C or less.

References

Packaging code	Specifications	Minimum quantity
D	φ180mm Paper taping	10000
B	Packing in bulk	1000

Mass (Typ.)	
1 piece	0.001g

Specifications

Inductance	390nH ±10%
Inductance test frequency	25MHz
Rated current (Itemp) (Based on Temperature rise)	300mA
Max. of DC resistance	0.675Ω
Avg. of DC resistance	0.54Ω±25%
Q (min.)	10
Q test frequency	25MHz
Self resonance frequency (min.)	80MHz
Operating temperature range	-55~125°C
Class of magnetic shield	Ferrite Core
Series	LQB15NN_10

Attention

- 1.This datasheet is downloaded from the website of Murata Manufacturing Co., Ltd. Therefore, it's specifications are subject to change or our products in it may be discontinued without advance notice. Please check with our sales representatives or product engineers before ordering.
- 2.This datasheet has only typical specifications because there is no space for detailed specifications. Therefore, please review our product specifications or consult the approval sheet for product specifications before ordering.

Chart of characteristic data (The charts below may show another part number which shares its characteristics.)

▪ Inductance-Current characteristics (Typ.)

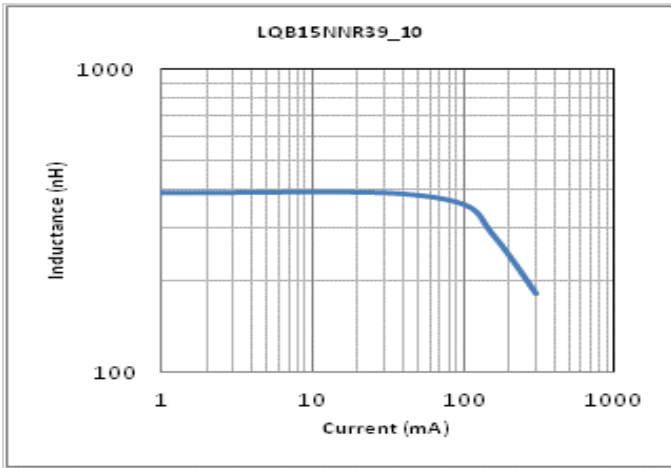

▪ Q-Frequency characteristics (Typ.)

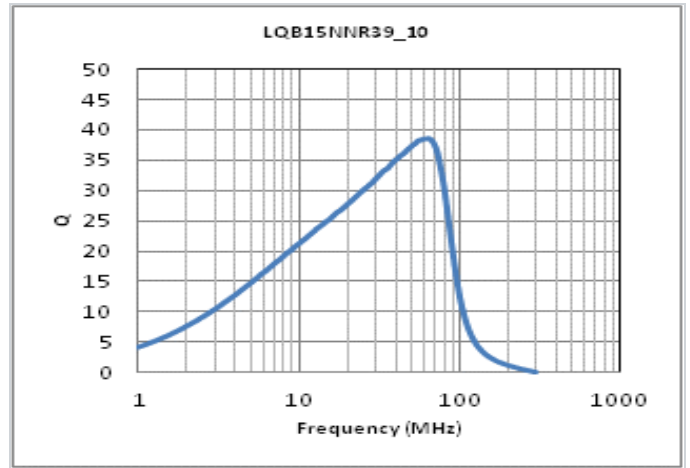

⚠ Attention

- 1.This datasheet is downloaded from the website of Murata Manufacturing Co., Ltd. Therefore, it's specifications are subject to change or our products in it may be discontinued without advance notice. Please check with our sales representatives or product engineers before ordering.
- 2.This datasheet has only typical specifications because there is no space for detailed specifications.
Therefore, please review our product specifications or consult the approval sheet for product specifications before ordering.