

GA352QR7GF681KW01#

"#" indicates a package specification code.



< List of part numbers with package codes >
GA352QR7GF681KW01L , GA352QR7GF681KW01K

Shape

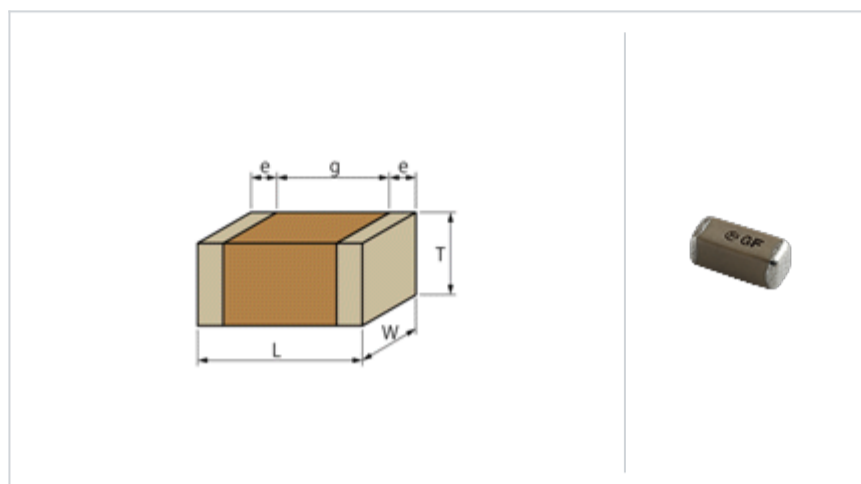

L size	5.7 ± 0.4mm
W size	2.8 ± 0.3mm
T size	1.5 +0.0/-0.3mm
External terminal width e	0.3mm min.
Distance between external terminals g	4.0mm min.
Size code in inch(mm)	2211 (5728)

Notes

X1/Y2 Class Certified Products

References

Packaging	Specifications	Minimum quantity
L	180mm Embossed taping	1000
K	330mm Embossed taping	4000

Mass (typ.)	
1 piece	120mg

Specifications

Capacitance	680pF ± 10%
Rated voltage	250Vac
Temperature characteristics (complied standard)	X7R(EIA)
Capacitance change rate	± 15.0%
Temperature range of temperature characteristics	-55 to 125
Operating temperature range	-55 to 125

⚠ Attention

- 1.This datasheet is downloaded from the website of Murata Manufacturing Co., Ltd. Therefore, it ' s specifications are subject to change or our products in it may be discontinued without advance notice. Please check with our sales representatives or product engineers before ordering.
- 2.This datasheet has only typical specifications because there is no space for detailed specifications. Therefore, please review our product specifications or consult the approval sheet for product specifications before ordering.

▪ Frequency characteristics (ESR, Impedance)

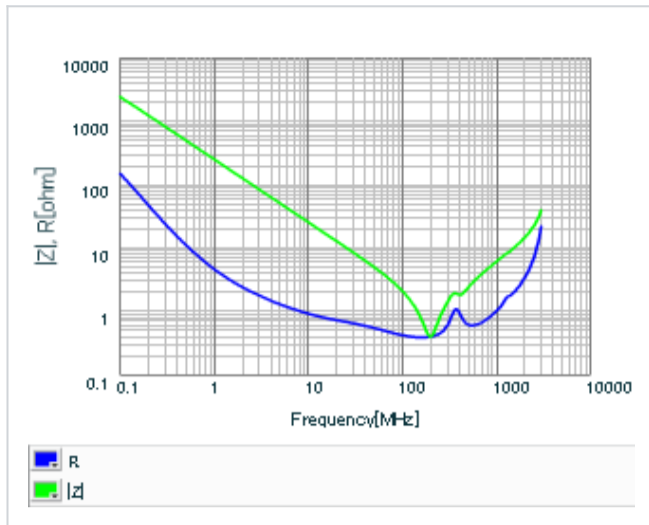

▪ S parameter (Smith chart S11)

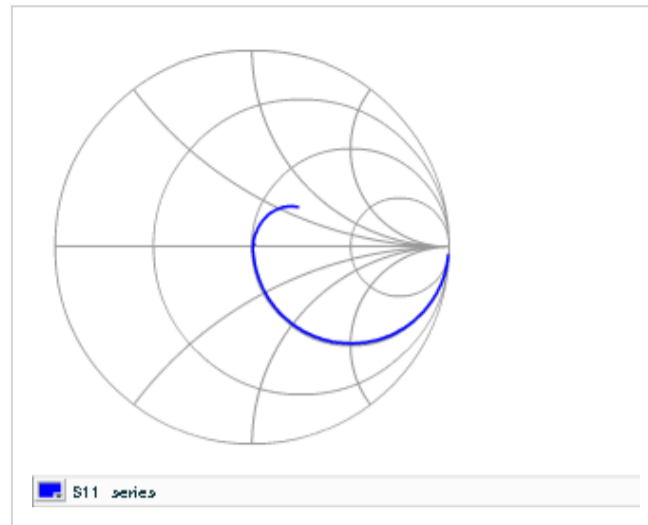

▪ DC bias characteristics

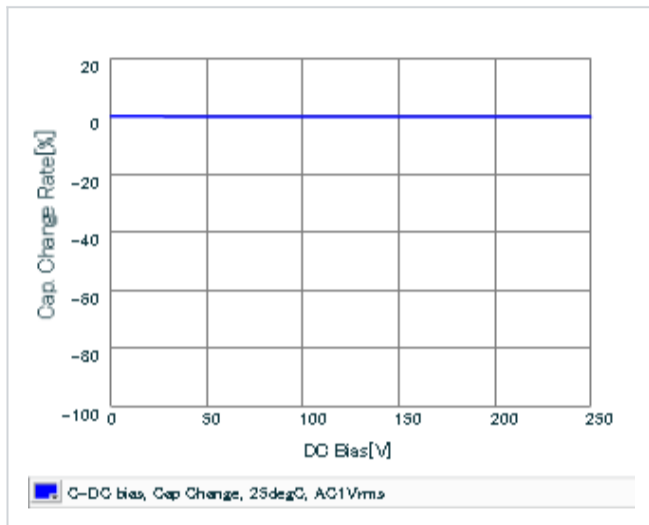

▪ AC voltage characteristics

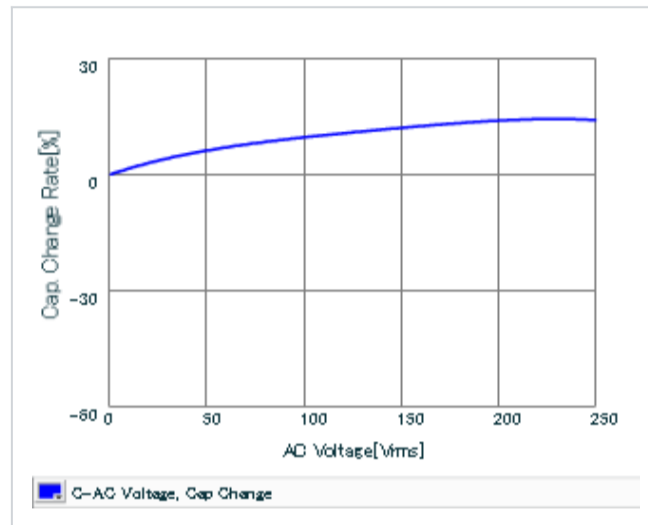

▪ Capacitance - temperature characteristics

