

The documentation and process conversion measures necessary to comply with this revision shall be completed by 1 May 2013.

INCH-POUND

MIL-PRF-19500/406K
w/AMENDMENT 2
1 April 2013
SUPERSEDING
MIL-PRF-19500/406K
w/AMENDMENT 1
9 November 2012

PERFORMANCE SPECIFICATION SHEET

SEMICONDUCTOR DEVICES, DIODE, SILICON, VOLTAGE REGULATOR, TYPES 1N4460, 1N4460C, 1N4460D THROUGH 1N4496, 1N4496C, 1N4496D, AND 1N6485, 1N6485C, 1N6485D THROUGH 1N6491, 1N6491C, 1N6491D, 1N4460US, 1N4460CUS, 1N4460DUS THROUGH 1N4496US, 1N4496CUS, 1N4496DUS, AND 1N6485US, 1N6485CUS, 1N6485DUS THROUGH 1N6491US, 1N6491CUS, 1N6491DUS, 1N4460UM THROUGH 1N4496UM, PLUS C AND D TOLERANCE SUFFIX; JAN, JANTX, JANTXV, AND JANS

This specification is approved for use by all Departments and Agencies of the Department of Defense.

The requirements for acquiring the product described herein shall consist of this specification sheet and MIL-PRF-19500.

1. SCOPE

1.1 Scope. This specification covers the performance requirements for micro-miniature 1.5 watt silicon, low leakage, voltage regulator diodes with tolerances of 5 percent, 2 percent, and 1 percent. Four levels of product assurance are provided for each encapsulated device type as specified in MIL-PRF-19500.

1.2 Physical dimensions. See [figure 1](#) (DO-41), [figure 2](#) (surface mount), and [figure 3](#) (UM surface mount).

1.3 Maximum ratings. $T_{STG} = T_{J(max)} = -65^{\circ}C$ to $+175^{\circ}C$. Maximum ratings are as shown in maximum and primary test ratings (see [3.11](#)) herein and as follows:

P_T at $T_L = +112^{\circ}C$ $L = .375$ inch (9.53 mm)	P_T at $T_{EC} = +145^{\circ}C$	$P_{T(PCB1)}$ at $T_A = +55^{\circ}C$	$P_{T(PCB2)}$ $T_A = +55^{\circ}C$	P_T At $T_{SP} = +25^{\circ}C$	$R_{\theta JL}$ at $L = .375$ inch (9.52 mm)
1.5 W (1)	1.5 W (2)	0.6 W (3)	1.5 W (4)	1.5 W (5)	42°C/W (6)

$R_{\theta JEC}$	$R_{\theta JSP}$	$R_{\theta JA(PCB1)}$	$R_{\theta JA(PCB2)}$	Barometric pressure reduced (high altitude operation)
20°C/W (6) (7)	56°C/W (8)	200°C/W (3)	80°C/W (4)	8 mm Hg

- (1) Derate: See [figure 4](#) herein.
- (2) Derate: See [figure 5](#) herein.
- (3) Derate: See [figure 6](#) herein and [6.4.1](#) (PCB1) herein.
- (4) Derate: See [figure 7](#) herein and [6.4.2](#) (PCB2) herein.
- (5) Derate: See [figure 8](#) herein.
- (6) See [figures 9](#) and [10](#) herein.
- (7) See [figures 11](#) and [12](#) herein.
- (8) See [figure 13](#) herein.

Comments, suggestions, or questions on this document should be addressed to DLA Land and Maritime, ATTN: VAC, P.O. Box 3990, Columbus, OH 43218-3990, or emailed to Semiconductor@dla.mil. Since contact information can change, you may want to verify the currency of this address information using the ASSIST Online database at <https://assist.dla.mil>.

MIL-PRF-19500/406K
w/AMENDMENT 2

1.4 Primary electrical characteristics. Primary electrical characteristics are as shown in maximum and primary test ratings (see 3.11) and as follows: $3.3 \text{ V dc} \leq V_Z \leq 200 \text{ V dc}$ (nominal).

- a. 1N4460D through 1N4496D and 1N6485D through 1N6491D are 1 percent voltage tolerance.
- b. 1N4460C through 1N4496C and 1N6485C through 1N6491C are 2 percent voltage tolerance.
- c. 1N4460 through 1N4496 and 1N6485 through 1N6491 are 5 percent voltage tolerance.
 $R_{\theta JL} = 42^\circ\text{C/W}$ (max) at $L = .375$ inch (9.52 mm) (nonsurface mount).
 $R_{\theta JEC} = 20^\circ\text{C/W}$ (max) (non-surface mount).
For thermal impedance curves, see figures 9, 10, 11, 12 and 13.
 $R_{\theta JSP} = 56^\circ\text{C/W}$ (max) (UM surface mount).

2. APPLICABLE DOCUMENTS

2.1 General. The documents listed in this section are specified in sections 3, 4, or 5 of this specification. This section does not include documents cited in other sections of this specification or recommended for additional information or as examples. While every effort has been made to ensure the completeness of this list, document users are cautioned that they must meet all specified requirements of documents cited in sections 3, 4, or 5 of this specification, whether or not they are listed.

2.2 Government documents.

2.2.1 Specifications, standards, and handbooks. The following specifications, standards, and handbooks form a part of this document to the extent specified herein. Unless otherwise specified, the issues of these documents are those cited in the solicitation or contract.

DEPARTMENT OF DEFENSE SPECIFICATIONS

MIL-PRF-19500 - Semiconductor Devices, General Specification for.

DEPARTMENT OF DEFENSE STANDARDS

MIL-STD-750 - Test Methods for Semiconductor Devices.

(Copies of these documents are available online at <https://assist.dla.mil/quicksearch/> or <https://assist.dla.mil> . or from the Standardization Document Order Desk, 700 Robbins Avenue, Building 4D, Philadelphia, PA 19111-5094.)

2.3 Order of precedence. Unless otherwise noted herein or in the contract, in the event of a conflict between the text of this document and the references cited herein, the text of this document takes precedence. Nothing in this document, however, supersedes applicable laws and regulations unless a specific exemption has been obtained.

MIL-PRF-19500/406K
w/AMENDMENT 2

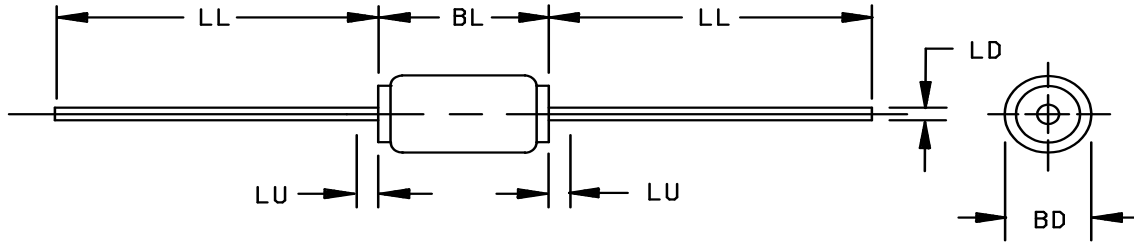

Ltr	Dimensions				Notes
	Inches		Millimeters		
	Min	Max	Min	Max	
BD	.060	.085	1.52	2.16	3
BL	.106	.160	2.69	4.06	3
LD	.028	.032	0.71	0.81	
LL	.800	1.300	20.32	33.02	
LU		.050		1.27	4

NOTES:

1. Dimensions are in inches.
2. Millimeters are given for general information only.
3. Package contour optional with BD and length BL. Heat slugs, if any, shall be included within this cylinder length but shall not be subject to minimum limit of BD.
4. The specified lead diameters apply in the zone between .050 inch (1.27 mm) from the diode body and the end of the lead.
5. In accordance with ASME Y14.5M, diameters are equivalent to Φ x symbology.

FIGURE 1. Physical dimensions of non-surface mount device (DO-41).

MIL-PRF-19500/406K
w/AMENDMENT 2

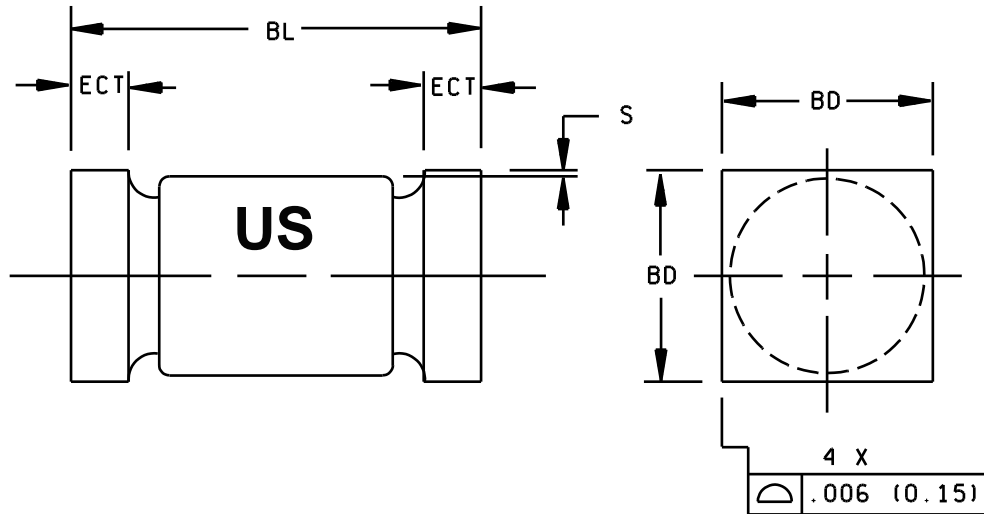

Ltr	Dimensions			
	Inches		Millimeters	
	Min	Max	Min	Max
BD	.091	.103	2.31	2.62
BL	.168	.200	4.28	5.08
ECT	.019	.028	0.48	0.71
S	.003		0.08	

NOTES:

1. Dimensions are in inches.
2. Millimeters are given for general information only.
3. Dimensions are pre-solder dip.
4. In accordance with ASME Y14.5M, diameters are equivalent to Φ x symbology.

FIGURE 2. Physical dimensions of surface mount device (US).

MIL-PRF-19500/406K
w/AMENDMENT 2

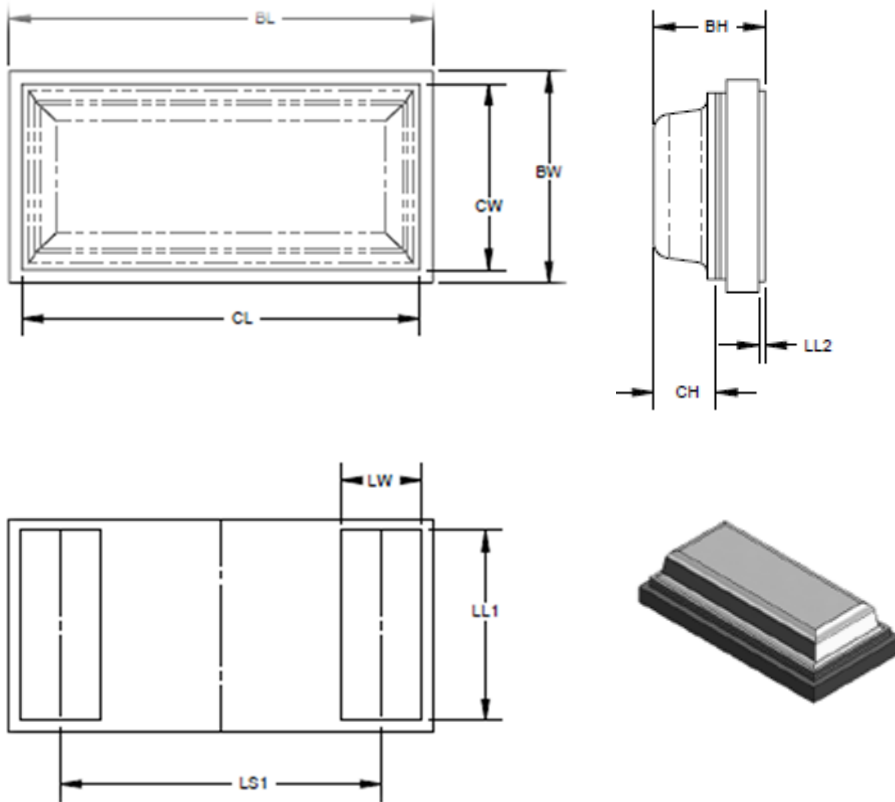

Ltr	Dimensions			
	Inches		Millimeters	
	Min	Max	Min	Max
BL	.192	.202	4.877	5.131
BW	.093	.104	2.362	2.642
BH	.044	.062	1.117	1.574
LW	.030	.044	.762	1.118
LL1	.083	.094	2.108	2.387
LL2	.0024	.0035	.0609	.0889
LS1	.144	.155	3.657	3.937
CH	.020	.034	.508	.864
CL	.179	.191	4.546	4.851
CW	.081	.093	2.057	2.362

FIGURE 3. Physical dimensions of DPC surface mount device, UM.

MIL-PRF-19500/406K
w/AMENDMENT 2

3. REQUIREMENTS

3.1 General. The individual item requirements shall be as specified in MIL-PRF-19500 and as modified herein.

3.2 Qualification. Devices furnished under this specification shall be products that are authorized by the qualifying activity for listing on the applicable qualified manufacturer's list (QML) before contract award (see 4.2 and 6.3).

3.3 Abbreviations, symbols, and definitions. The abbreviations, symbols, and definitions used herein shall be as specified in MIL-PRF-19500, and as follows:

EC	End-cap.
IZT	Zener test current.
US	Surface mount case outline, square end-cap.
UM	Surface mount case outline, DPC package.
ZK	Knee impedance.
α_{VZ}	Temperature coefficient.

3.4 Interface and physical dimensions. Interface and physical dimensions shall be as specified in MIL-PRF-19500, and on figures 1 and 2 herein.

* 3.4.1 Diode construction (except UM version). All devices shall be metallurgically bonded, double plug construction, thermally matched, and non-cavity in accordance with the requirements of MIL-PRF-19500. US version devices shall be structurally identical to the axial leaded type except for lead attachment.

3.4.1.1 Metallurgical bond for diodes with V_Z greater than 6.8 V dc (except UM version). These devices shall be constructed utilizing category I metallurgical bonds for diodes with V_Z greater than 6.8 V dc as defined in MIL-PRF-19500.

3.4.1.2 Metallurgical bond for diodes with V_Z less than or equal to 6.8 V dc (except UM version). These devices shall be constructed utilizing category I or category III metallurgical bonds as defined in MIL-PRF-19500.

3.5 Marking. Marking shall be in accordance with MIL-PRF-19500.

3.5.1 Marking of US devices. US devices shall be marked with a cathode band as a minimum; or a minimum of three evenly spaced contrasting color dots around the periphery of the cathode end may be used. At the option of the manufacturer, US devices may include laser marking on an end-cap, to include part number and lot date code for all levels. JANS devices which are laser marked shall also include serialization. The prefixes JAN, JANTX, JANTXV, or JANS may be abbreviated as J, JX, JV, or JS, respectively. (For example: The part number may be reduced to JS4460). All device marking, except for polarity and serial numbers, shall also appear on the unit package used as the initial protection for delivery.

3.5.2 Marking of UM version devices. For UM version devices only, all marking shall be on lid to include part number, date code, serial number and cathode end.

3.6 Lead finish. Lead finish shall be solderable in accordance with MIL-PRF-19500, MIL-STD-750, and herein. When solder alloy is used for lead finish the maximum lead temperature shall be 175°C max. Where a choice of lead finish is desired, it shall be specified in the acquisition document (see 6.2).

* 3.7 Polarity. The polarity of all types shall be indicated with a contrasting color band to denote the cathode end. For UM devices, a line on the lid shall denote the cathode end.

MIL-PRF-19500/406K
w/AMENDMENT 2

3.8. Selection of tighter tolerance devices. The C and D suffix devices shall be selected from JAN, JANTX, JANTXV, or JANS devices, which have successfully completed all applicable screening, and groups A, B, and C testing as ± 5 percent tolerance devices. All sublots of C and D suffix devices shall pass [table I](#), subgroup 2, at tightened tolerances. Tighter tolerances for mounting clip temperature shall be maintained for reference purposes to establish correlation. For C and D tolerance levels, $T_L = 25^\circ\text{C}, +1^\circ\text{C}, -3^\circ\text{C}$ at .375 inch (9.53 mm) from body, or zero inches for surface mount devices or equivalent.

3.9. Electrical performance characteristics. Unless otherwise specified herein, the electrical performance characteristics are as specified in [1.3](#), [1.4](#), [table I](#) and [table II](#) herein.

3.10. Electrical test requirements. The electrical test requirements shall be the subgroups specified in [table I](#) herein.

3.11. Maximum and primary test ratings. Maximum and primary test ratings for voltage regulator diodes are specified in [table III](#) herein.

3.12. Workmanship. Semiconductor devices shall be processed in such a manner as to be uniform in quality and shall be free from other defects that will affect life, serviceability, or appearance.

4. VERIFICATION

4.1. Classification of inspections. The inspection requirements specified herein are classified as follows:

- a. Qualification inspection (see [4.2](#)).
- b. Screening (see [4.3](#)).
- c. Conformance inspection (see [4.4](#)).

4.2. Qualification inspection. Qualification inspection shall be in accordance with MIL-PRF-19500, and as specified herein.

4.2.1 Group E qualification. Group E inspection shall be performed for qualification or requalification only. In case qualification was awarded to a prior revision of the specification sheet that did not request the performance of [table II](#) tests, the tests specified in [table II](#) herein that were not performed in the prior revision shall be performed on the first inspection lot of this revision to maintain qualification.

MIL-PRF-19500/406K
w/AMENDMENT 2

4.3 Screening (JANS, JANTXV and JANTX levels only). Screening shall be in accordance with table E-IV of MIL-PRF-19500, and as specified herein. The following measurements shall be made in accordance with table I herein. Devices that exceed the limits of table I herein shall not be acceptable.

Screen (see table E-IV of MIL-PRF-19500)	Measurements	
	JANS level	JANTX and JANTXV levels
3b (1) 3c	Not applicable Thermal impedance, see 4.3.1	Not applicable Thermal impedance, see 4.3.1
9	I_{R1} and V_Z (1N4466 thru 1N4496 only)	Not applicable
10	Required for device > 10 V dc.	Not applicable
11	I_{R1} and V_Z $\Delta I_{R1} \leq \pm 100$ percent of initial reading or 50 nA, whichever is greater. $\Delta V_Z \leq \pm 2$ percent of initial reading (2)	I_{R1} and V_Z
12	Required see 4.3.2	Required see 4.3.2
13	Scope display see 4.5.7 Subgroups 2 and 3 of table I herein; ΔI_{R1} (max) $\leq \pm 100$ percent of initial reading or 25 percent of column 12 in table III (1N6485 – 1N4466); 50 nA (1N4467 – 1N4496), whichever is greater; $\Delta V_Z \leq \pm 2$ percent of initial reading	Subgroup 2 of table I herein; ΔI_{R1} (max) $\leq \pm 100$ percent of initial reading or 25 percent of column 12 in table III (1N6485 – 1N4466); 50 nA (1N4467 – 1N4496), whichever is greater; $\Delta V_Z \leq \pm 2$ percent of initial reading

(1) Shall be performed any time after temperature cycling, screen 3a; JANTX and JANTXV levels do not need to be repeated in screening requirements.

4.3.1 Thermal impedance. The thermal impedance measurements shall be performed in accordance with method 3101 or 4081 of MIL-STD-750, as applicable, using the guidelines in that method for determining I_M , I_H , t_H , t_{SW} (V_C and V_H where appropriate). See table II, group E, subgroup 4 herein.

4.3.2 Free air power burn-in conditions. Power burn-in conditions are as follows (see 4.5.6): $T_A = 75^\circ\text{C}$ maximum. Test conditions in accordance with method 1038 of MIL-STD-750, condition B. Adjust I_Z or T_A to achieve the required T_J , and $I_{Z(\min)}$ shall be ≥ 50 percent of column 8 of table III. $T_J = 135^\circ\text{C}$ minimum. With approval of the qualifying activity and preparing activity, alternate burn-in criteria (hours, bias conditions, T_J , mounting conditions) may be used for JANTX and JANTXV quality levels. A justification demonstrating equivalence is required. In addition, the manufacturing site's burn-in data and performance history will be essential criteria for burn-in modification approval.

4.4 Conformance inspection. Conformance inspection shall be in accordance with MIL-PRF-19500 and as specified herein.

4.4.1 Group A inspection. Group A inspection shall be in accordance with MIL-PRF-19500 and table I herein.

4.4.2 Group B inspection. Group B inspection shall be conducted in accordance with the conditions specified for subgroup testing in appendix E, table E-VIa (JANS) and E-VIb (JAN, JANTX, and JANTXV) of MIL-PRF-19500. Electrical measurements (end-points) shall be in accordance with the applicable inspections of table I, subgroup 2 herein. $Z_{\theta JX}$ is an end-point for these subgroups: B2 and B3 (JAN, JANTX, and JANTXV product levels only).

MIL-PRF-19500/406K
w/AMENDMENT 2

4.4.2.1 Group B inspection, table E-VIa (JANS) of MIL-PRF-19500.

<u>Subgroup</u>	<u>Method</u>	<u>Condition</u>
B3	1056	0°C to +100°C, 25 cycles, n = 22, c = 0.
B3	1051	-55°C to +175°C, 100 cycles, n = 22, c = 0.
B3	1071	Fine leak and gross leak shall be performed for UM version devices. Test condition E shall be performed for non-UM version devices. NOTE: For non-transparent devices, hermetic seal may be performed after electrical measurements.
B4	1037	I _Z = 80 percent of column 8 of table III at T _A = room ambient as defined in the general requirements of 4.5 of MIL-STD-750; for 2,000 cycles.
B5	1027	I _Z = 50 percent of column 8 of table III minimum; adjust either T _A , and or I _Z to achieve T _J minimum. Temporary leads may be added for surface mount devices, n = 45, c = 0. Option 1: T _A = +100°C max; T _J = +275°C minimum; t = 96 hours. n = 22, c = 0. Option 2: T _A = +100°C max; T _J = +175°C minimum; t = 1,000 hours. n = 45, c = 0.

4.4.2.2 Group B inspection, table E-VIb (JAN, JANTX, and JANTXV of MIL-PRF-19500).

<u>Subgroup</u>	<u>Method</u>	<u>Condition</u>
B2	1056	0°C to +100°C, 10 cycles, n = 22, c = 0.
B2	1051	-55°C to +175°C, 25, cycles, n = 22, c = 0.
B2	1071	Fine leak and gross leak shall be performed for UM version devices. Test condition E shall be performed for non-UM version devices. NOTE: For non-transparent devices, hermetic seal may be performed after electrical measurements.
B3	1027	I _{Z(min)} = 50 percent of column 8 of table III minimum. Adjust either T _A , I _Z , or both to achieve T _J = 150°C min (see 4.5.6).

MIL-PRF-19500/406K
w/AMENDMENT 2

4.4.3 Group C inspection. Group C inspection shall be conducted in accordance with the conditions specified for subgroup testing in appendix E, table E-VII of MIL-PRF-19500 and herein. Electrical measurements (end-points) shall be in accordance with the applicable inspections of [table I](#), subgroup 2 herein. $Z_{\theta JX}$ is an end-point for these subgroups: C2 and C6 (JAN, JANTX, and JANTXV product levels only).

* 4.4.3.1 Group C inspection, table E-VII of MIL-PRF-19500.

<u>Subgroup</u>	<u>Method</u>	<u>Condition</u>
C2	1056	0°C to +100°C, 15 cycles, n = 22, c = 0.
C2	1051	-55°C to +175°C, 25 cycles, n = 22, c = 0.
C2	1071	Fine leak and gross leak shall be performed for UM version devices. Test condition E shall be performed for non-UM version devices. NOTE: For non-transparent devices, hermetic seal may be performed after electrical measurements.
C2	2036	Tension - test condition A; 10 lbs; t = 15 s ±3 s. Lead fatigue - Test condition E. NOTE: Not applicable to US and UM versions.
C2	2036	US, URS devices - Tension: Condition A, 10 pounds, t = 15s. Suitable fixtures may be used to pull the end-caps in a manner which does not aid construction. Reference to axial lead may be interpreted as end-cap with fixtures used for mounting (see figure 14 herein).
C5	4081	$R_{\theta JL}$ and $R_{\theta JEC}$ see 1.3 and 4.3.2 herein.
C6	1026	$I_{Z(min)}$ = 50 percent of column 8 of table III minimum. Adjust I_Z or T_A to achieve $T_J = 150^\circ\text{C}$ min (see 4.5.6).
* C7	1018	Not applicable, except for UM package.
C8	4071	Temperature coefficient for JAN, JANTX, and JANTXV only; I_Z = column 5 of table III ; $T_{A1} = +25^\circ\text{C} \pm 5^\circ\text{C}$; $T_{A2} = +125^\circ\text{C} \pm 5^\circ\text{C}$; limit = column 13 of table III (see 4.5.3), n = 22, c = 0.

4.4.4 Group E inspection. Group E inspection shall be conducted in accordance with the conditions specified for subgroup testing in table E-IX of MIL-PRF-19500 and as specified in [table II](#) herein. Electrical measurements (end-points) shall be in accordance with [table I](#), subgroup 2 herein.

MIL-PRF-19500/406K
w/AMENDMENT 2

4.5 Methods of inspection. Methods of inspection shall be as specified in the appropriate tables and as follows.

4.5.1 Voltage regulation ($V_{Z(\text{reg})}$). The breakdown voltage shall be measured at $I_Z = 10$ percent of column 8 of [table III](#) and at $I_Z = 50$ percent of column 8 of [table III](#). The difference between these voltages shall then be determined and shall not exceed column 9 of [table III](#). The voltage measurement at $I_Z = 10$ percent of column 8 of [table III](#) shall be a pulse measurement in accordance with [4.5.5](#). The measurement at $I_Z = 50$ percent of column 8 of [table III](#) shall be made after current has been applied for 30 ± 3 seconds. For this time interval, the device shall be suspended in free air by its leads with mounting clips with inside edge .375 inch (9.53 mm) from the body, and the point of connection shall be maintained at a temperature of $+25^\circ\text{C}$, $+8^\circ\text{C}$, -2°C . No forced air across the device shall be permitted. US suffix devices shall be mounted with the end-caps maintained at $+25^\circ\text{C}$, $+8^\circ\text{C}$, -2°C . For JANHC and JANKC, the die shall be stabilized at $+25^\circ\text{C}$ and the test shall be performed utilizing pulse conditions. The ΔV_Z measurement may be performed after a shorter time interval following application of the test current if correlation can be established to the satisfaction of the qualifying activity.

4.5.2 Surge current (I_{ZSM}). The peak currents specified in column 10 of [table III](#) shall be applied in the reverse direction and shall be superimposed on the current ($I_Z =$ column 5 of [table III](#)) a total of five surges at 1 minute intervals. Each individual surge shall be at one-half square wave pulse of 8.3 millisecond duration or an equivalent sine wave with the same effective (rms) current.

4.5.3 Temperature coefficient of regulator voltage (α_{VZ}). The device shall be temperature stabilized with current applied prior to reading regulator voltage at the specified ambient temperature.

4.5.4 Regulator voltage. The test current (column 5 of [table III](#)) shall be applied until thermal equilibrium is attained prior to reading the regulator voltage. For this test, the diode shall be suspended by its leads (non-surface mount) with mounting clips whose inside edge is located at $.375 \pm .010$ inch (9.53 ± 0.25 mm) from the body and the lead temperature at inside edge of the mounting clips shall be maintained at a temperature of $+23^\circ\text{C}$ to $+33^\circ\text{C}$. For surface mount diodes, the diode shall be suspended by the end-caps with the temperature of the end-caps being maintained at $+23^\circ\text{C}$ to $+33^\circ\text{C}$. This measurement may be performed after a shorter time following application of the test current than that which provides thermal equilibrium if correlation to stabilized readings can be established to the satisfaction of the qualifying activity.

4.5.5 Pulse measurements. Conditions for pulse measurements shall be as specified in section 4 of MIL-STD-750.

4.5.6 Free air power burn-in and life tests. The use of a current limiting or ballast resistor is permitted provided that each DUT still sees at least $I_{Z(\text{min})}$ described in [4.3.2](#) and that the minimum applied voltage, where applicable, is maintained through-out the burn-in period. Use method 3100 of MIL-STD-750 to measure T_J .

4.5.7 Scope display evaluation. Scope display evaluation shall be sharp and stable in accordance with method 4023 of MIL-STD-750. Scope display may be performed on ATE (automatic test equipment) for screening only, with the approval of the qualifying activity. Scope display in [table I](#), subgroup 4 shall be performed on a scope. The reverse current (I_{BR}) over the knee shall be 500 μA peak.

4.5.7.1 Scope display option. At the suppliers option, 100-percent scope display evaluation may be discontinued after three consecutive lots are 100-percent tested with zero failures. Any [table I](#) failure shall require 100-percent scope display to be re-invoked.

MIL-PRF-19500/406K
w/AMENDMENT 2

TABLE I. Group A inspection.

Inspection <u>1/</u>	MIL-STD-750		Symbol	Limits <u>2/</u>		Unit
	Method	Conditions		Min	Max	
<u>Subgroup 1</u> Visual and mechanical examination	2071					
<u>Subgroup 2</u> Thermal impedance	3101	See 4.3.1	$Z_{\theta JX}$			°C/W
Forward voltage	4011	$I_F = 200$ mA dc	V_{F1}		1.0	V dc
Forward voltage	4011	$I_F = 1$ A dc	V_{F2}		1.5	V dc
Reverse current leakage	4016	DC method; $V_R =$ column 11 of table III	I_{R1}		Column 12	μA dc
Regulator voltage	4022	$I_Z =$ column 5 of table III (see 4.5.4)	V_Z	Column 3 -5, -2, -1 percent	Column 4 +5, +2, +1 percent	V dc
<u>Subgroup 3</u> High temperature operation		$T_A = +150^\circ\text{C}$				
Reverse current leakage	4016	DC method; $V_R =$ column 11 of table III	I_{R2}		Column 15	μA dc
<u>Subgroup 4</u> Small-signal reverse breakdown impedance	4051	$I_Z =$ column 5 of table III I_{sig} $= 10$ percent I_Z	Z_Z		Column 6	ohms
Knee impedance	4051	$I_{ZK} =$ column 14 of table III $I_{sig} = 10$ percent I_{ZK}	Z_{ZK}		Column 7	ohms
Scope display	4023	See 4.5.7				

See footnotes at end of table.

MIL-PRF-19500/406K
w/AMENDMENT 2

TABLE I. Group A inspection - Continued.

Inspection <u>1/</u>	MIL-STD-750		Symbol	Limits <u>2/</u>		Unit
	Method	Conditions		Min	Max	
<u>Subgroup 5</u> Not applicable						
<u>Subgroup 6</u> Surge current	4066	I_{ZSM} = column 10 of table III at $T_A + 25^\circ\text{C}$ (see 4.5.2)	I_{ZSM}		Column 10	
End-point electrical measurements		See table I , subgroup 2 except $Z_{\theta JX}$				
<u>Subgroup 7</u> Voltage regulation		See 4.5.4	$V_{Z(\text{reg})}$		Column 9	V dc
Temperature coefficient of regulator voltage	4071	JANS level only I_Z = column 5 of table III $T_{A1} = +25^\circ\text{C} \pm 5^\circ\text{C}$, $T_{A2} = 120^\circ\text{C} \leq T_2 \leq 130^\circ\text{C}$	α_{VZ}		Column 13	%/°C

1/ For sampling plan, see MIL-PRF-19500.

2/ Column references are to [table III](#).

MIL-PRF-19500/406K
w/AMENDMENT 2

TABLE II. Group E inspection (all quality levels).

Inspection ^{1/}	MIL-STD-750		Sampling plan
	Method	Conditions	
<u>Subgroup 1</u>			22 devices c = 0
Thermal shock	1056	20 cycles, condition D except low temperature shall be achieved using liquid nitrogen (-195°C). Perform a visual inspection for cracked glass.	
Temp cycling	1051	-65°C to +175°C, 500 cycles.	
Hermetic seal Fine leak Gross leak	1071	For UM version devices only.	
Electrical measurements		See table I , subgroup 2.	
<u>Subgroup 2</u>			22 devices c = 0
Steady-state intermittent operating life	1037	$I_Z = I_{Z2}$ (column 8 of table III) at T_A = room ambient for 10,000 cycles. No forced air cooling on the device shall be permitted.	
Electrical measurements		See table I , subgroup 2.	
<u>Subgroup 4</u>			Sample size N/A
Thermal impedance curves		See MIL-PRF-19500, table E-IX, group E, subgroup 4.	
<u>Subgroups 5 and 6</u>			
Not applicable			
<u>Subgroup 8</u>			45 devices c=0
Resistance to glass cracking (Not applicable for UM devices).	1057	Condition B. Step stress to destruction by increased cycles or up to a maximum of 25 cycles.	

^{1/} A separate sample may be pulled for each test.

TABLE III. Electrical characteristics and test conditions (all case outlines).

Col 1	Col 2	Col 3	Col 4	Col 5	Col 6	Col 7	Col 8	Col 9	Col 10	Col 11	Col 12	Col 13	Col 14	Col 15
Device type	V_Z Nom	V_Z Min 1/ 2/	V_Z Max 1/ 2/	I_Z test current $T_A =$ $+25^\circ\text{C}$	Z_Z Imped- ance	ZK Knee imped- ance	$I_{Z(\text{max})}$ dc current $T_A =$ $+25^\circ\text{C}$ 3/	$V_{Z(\text{reg})}$ Voltage regula- tion 4/	I_{ZSM} $T_A =$ $+25^\circ\text{C}$ 5/	V_R Reverse voltage	I_R Reverse current dc I_{R1}	α_{VZ} Temper- ature coeffi- cient 6/	I_{ZK} Test current	I_R $T_A =$ $+150^\circ\text{C}$ I_{R2}
	V	V	V	mA	Ω	Ω	mA	V	A	V	μA	%/ $^\circ\text{C}$	mA	μA
1N6485	3.3	3.14	3.46	76	10	400	433	0.9	4.2	1.0	50.00	-.075	1.00	500
1N6486	3.6	3.42	3.78	69	10	400	397	0.8	3.9	1.0	50.00	-.070	1.00	200
1N6487	3.9	3.71	4.09	64	9	400	366	.75	3.6	1.0	35.00	-.060	1.00	100
1N6488	4.3	4.09	4.51	58	9	400	332	.70	3.3	1.0	5.00	-.050	1.00	100
1N6489	4.7	4.47	4.93	53	8	500	304	.60	3.0	1.0	4.00	\pm .025	1.00	100
1N6490	5.1	4.85	5.35	49	7	500	280	.50	2.7	1.0	1.00	\pm .030	1.00	100
1N6491	5.6	5.32	5.88	45	5	600	255	.40	2.5	2.0	.50	\pm .040	1.00	100
1N4460	6.2	5.89	6.51	40	4	200	230	.35	2.3	3.72	10.00	+0.050	1.00	50
1N4461	6.8	6.46	7.14	37	2.5	200	210	.30	2.1	4.08	5.00	+0.057	1.00	20
1N4462	.5	7.13	7.87	34	2.5	400	191	.35	1.9	4.50	1.00	+0.061	0.50	10
1N4463	8.2	7.79	8.61	31	3.0	400	174	.40	1.7	4.92	0.50	+0.065	0.50	5
1N4464	9.1	8.65	9.55	28	4.0	500	157	.45	1.6	5.46	0.30	+0.068	0.50	3
1N4465	10	9.50	10.50	25	5.0	500	143	.50	1.4	8.0	0.30	+0.071	0.25	3
1N4466	11	10.45	11.55	23	6.0	550	130	.55	1.3	8.8	0.30	+0.073	0.25	2
1N4467	12	11.40	12.60	21	7.0	550	119	.60	1.2	9.6	0.20	+0.076	0.25	2
1N4468	13	12.35	13.65	19	8.0	550	110	.65	1.1	10.4	.05	+0.079	0.25	2
1N4469	15	14.25	15.75	17	9.0	600	95	.75	.95	12.0	.05	+0.082	0.25	2
1N4470	16	15.20	16.80	15.5	10.0	600	90	.80	.90	12.8	.05	+0.083	0.25	2
1N4471	18	17.10	18.90	14	11.0	650	79	.83	.79	14.4	.05	+0.085	0.25	2
1N4472	20	19.00	21.00	12.5	12.0	650	71	.95	.71	16.0	.05	+0.086	0.25	2
1N4473	22	20.90	23.10	11.5	14	650	65	1.0	.65	17.6	.05	+0.087	0.25	2
1N4474	24	22.80	25.20	10.5	16	700	60	1.1	.60	19.2	.05	+0.088	0.25	2
1N4475	27	25.70	28.30	9.5	18	700	53	1.3	.53	21.6	.05	+0.090	0.25	2
1N4476	30	28.50	31.50	8.5	20	750	48	1.4	.48	24.0	.05	+0.091	0.25	2
1N4477	33	31.40	34.60	7.5	25	800	43	1.5	.43	26.4	.05	+0.092	0.25	2

MIL-PRF-19500/406K
W/AMENDMENT 2

TABLE III. Electrical characteristics and test conditions (all case outlines) - Continued.

Col 1	Col 2	Col 3	Col 4	Col 5	Col 6	Col 7	Col 8	Col 9	Col 10	Col 11	Col 12	Col 13	Col 14	Col 15
Device type	V _Z Nom	V _Z Min 1/ 2/	V _Z Max 1/ 2/	I _Z test current T _A = +25°C	Z _Z Impedance	Z _K Knee impedance	I _{Z(max)} dc current T _A = +25°C 3/	V _{Z(reg)} Voltage regulation 4/	I _{ZSM} T _A = +25°C 5/	V _R Reverse voltage	I _R Reverse current dc I _{R1}	α _{VZ} Temperature coefficient 6/	I _{ZK} Test current	I _R T _A = +150°C I _{R2}
	V	V	V	mA	Ω	Ω	mA	V	A	V	μA	%/°C	mA	μA
1N4478	36	34.2	37.8	7.0	27	850	40	1.7	.40	28.8	.05	+0.093	0.25	2
1N4479	39	37.1	40.9	6.5	30	900	37	1.8	.37	31.2	.05	+0.094	0.25	2
1N4480	43	40.9	45.1	6.0	40	950	33	1.9	.33	34.4	.05	+0.095	0.25	2
1N4481	47	44.7	49.3	5.5	50	1000	30	2.1	.30	37.6	.05	+0.095	0.25	2
1N4482	51	48.5	53.5	5.0	60	1100	28	2.3	.28	40.8	.05	+0.096	0.25	2
1N4483	56	53.2	58.8	4.5	70	1300	26	2.5	.26	44.8	.25	+0.096	0.25	10
1N4484	62	58.9	65.1	4.0	80	1500	23	2.7	.23	49.6	.25	+0.097	0.25	10
1N4485	68	64.6	71.4	3.7	100	1700	21	3.0	.21	54.4	.25	+0.097	0.25	10
1N4486	75	71.3	78.7	3.3	130	2000	19	3.3	.19	60.0	.25	+0.098	0.25	10
1N4487	82	77.9	86.1	3.0	160	2500	17	3.6	.17	65.6	.25	+0.098	0.25	10
1N4488	91	86.5	95.5	2.8	200	3000	16	4.0	.16	72.8	.25	+0.099	0.25	10
1N4489	100	95.0	105.0	2.5	250	3100	14	4.4	.14	80.0	.25	+0.100	0.25	10
1N4490	110	104.5	115.5	2.3	300	4000	13	5.0	.13	88.0	.25	+0.100	0.25	10
1N4491	120	114.0	126.0	2.0	400	4500	12	5.5	.12	96.0	.25	+0.100	0.25	10
1N4492	130	123.5	136.5	1.9	500	5000	11	6.0	.11	104	.25	+0.100	0.25	10
1N4493	150	142.5	157.5	1.7	700	6000	9.5	7.0	.095	120	.25	+0.100	0.25	10
1N4494	160	152	168	1.6	1000	6500	8.9	8.0	.089	128	.25	+0.100	0.25	10
1N4495	180	171	189	1.4	1300	7000	7.9	10.0	.079	144	.25	+0.100	0.25	10
1N4496	200	190	210	1.2	1500	8000	7.2	12.0	.072	160	.25	+0.100	0.25	10

1/ See 4.5.5. Voltages shown are for 5 percent tolerance devices. Voltages for 2 and 1 percent tolerances devices shall be calculated accordingly.

2/ 1N4460D through 1N4496D and 1N6485D through 1N6491D are 1 percent voltage tolerance.

1N4460C through 1N4496C and 1N6485C through 1N6491C are 2 percent voltage tolerance.

1N4460 through 1N4496 and 1N6485 through 1N6491 are 5 percent voltage tolerance.

3/ See 1.3 for P_T temperature conditions for lead, end-cap and UM package where I_{ZM} is applicable.

4/ See 4.5.1.

5/ See 4.5.2.

6/ See 4.5.3.

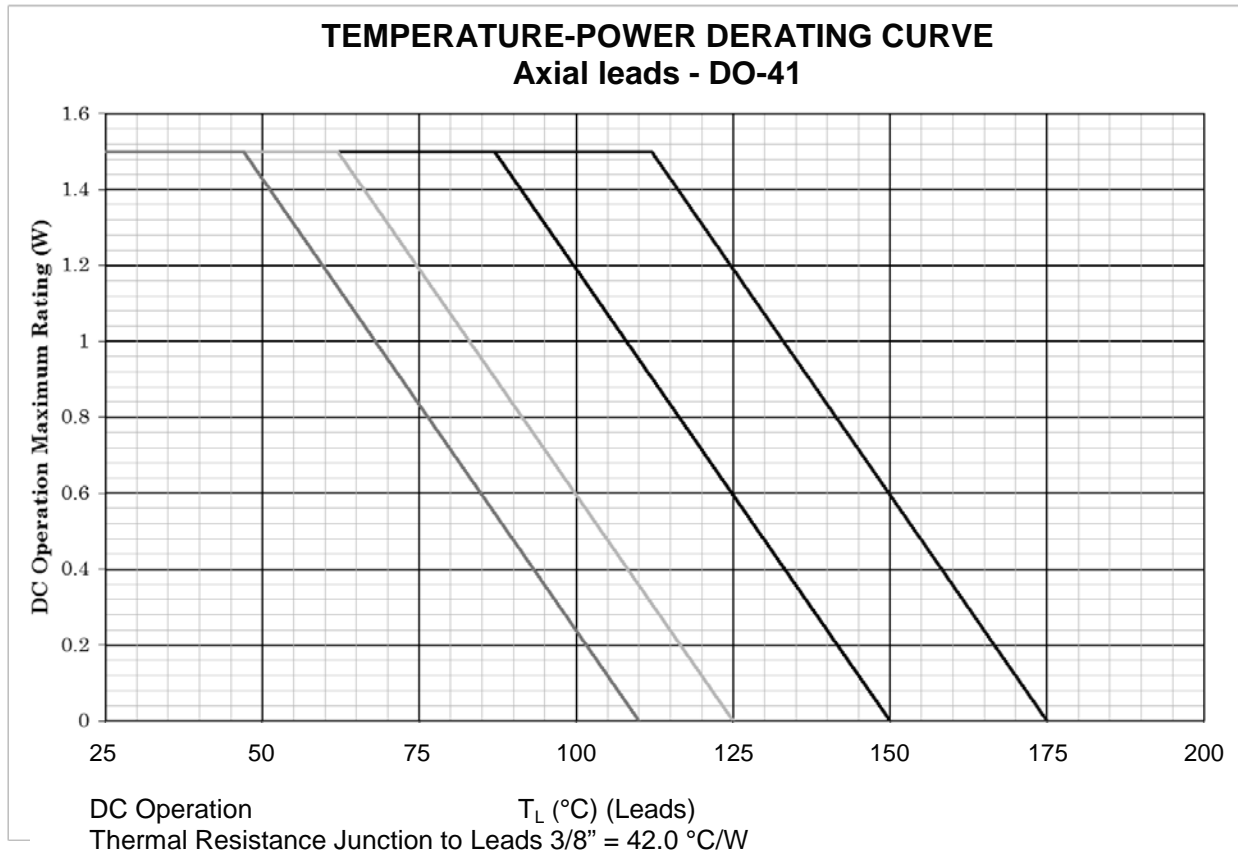

NOTES:

1. All devices are capable of operating at $\leq T_J$ specified on this curve. Any parallel line to this curve will intersect the appropriate power for the desired maximum T_J allowed.
2. Derate design curve constrained by the maximum junction temperature ($T_J \leq 175^\circ\text{C}$) and power rating specified. (See 1.3 herein.)
3. Derate design curve chosen at $T_J \leq 150^\circ\text{C}$, where the maximum temperature of electrical test is performed.
4. Derate design curves chosen at $T_J \leq 125^\circ\text{C}$, and 110°C to show power rating where most users want to limit T_J in their application.

FIGURE 4. Temperature/power derating curve.

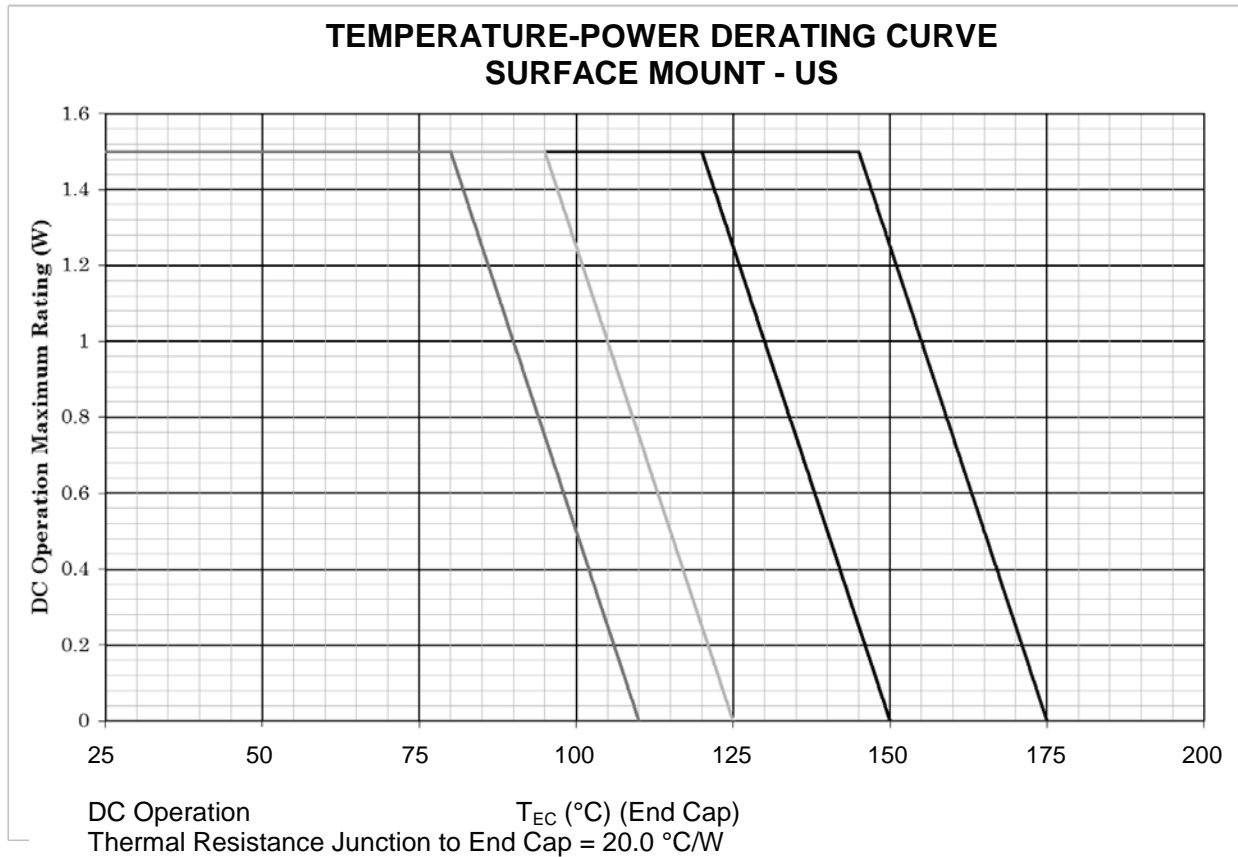

NOTES:

1. All devices are capable of operating at $\leq T_J$ specified on this curve. Any parallel line to this curve will intersect the appropriate power for the desired maximum T_J allowed.
2. Derate design curve constrained by the maximum junction temperature ($T_J \leq 175^\circ\text{C}$) and power rating specified. (See 1.3 herein.)
3. Derate design curve chosen at $T_J \leq 150^\circ\text{C}$, where the maximum temperature of electrical test is performed.
4. Derate design curves chosen at $T_J \leq 125^\circ\text{C}$, and 110°C to show power rating where most users want to limit T_J in their application.

FIGURE 5. Temperature/power derating curve.

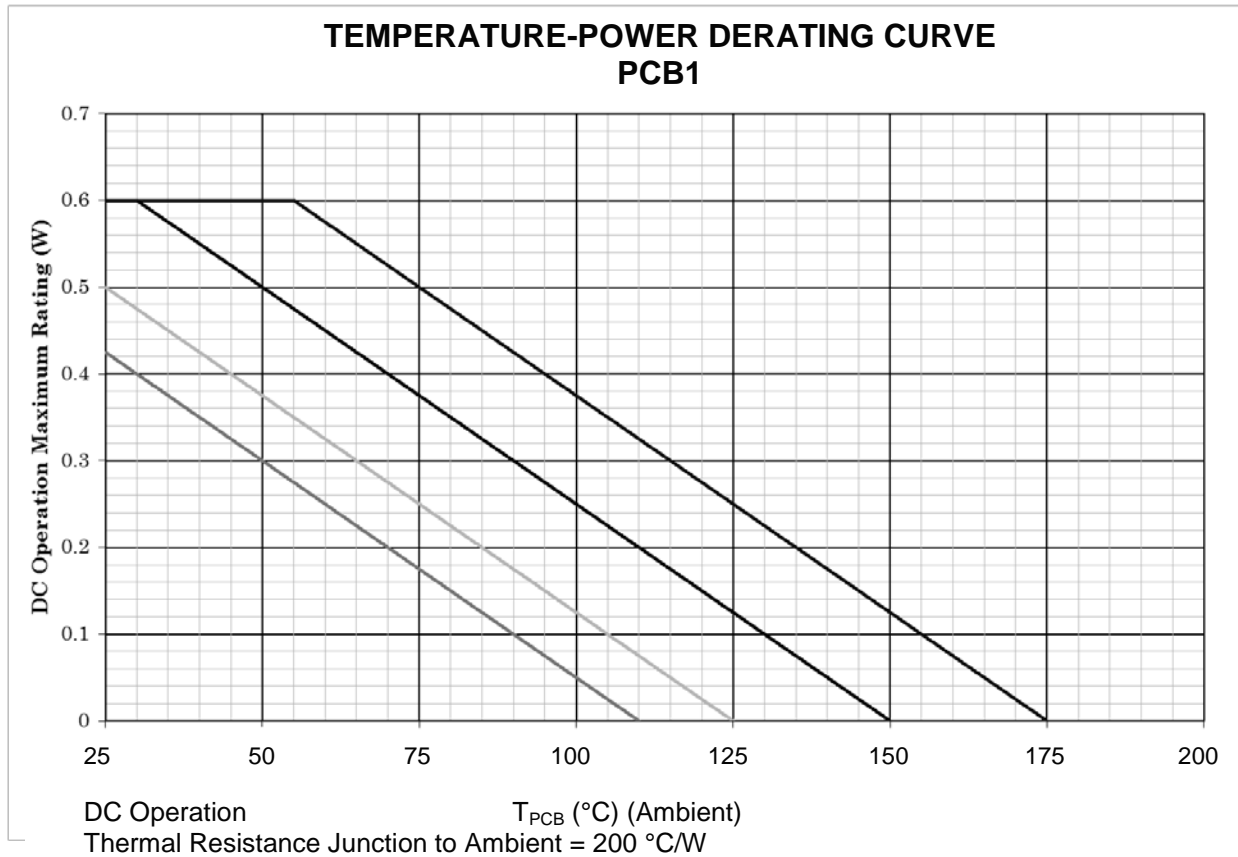

NOTES:

1. All devices are capable of operating at $\leq T_J$ specified on this curve. Any parallel line to this curve will intersect the appropriate power for the desired maximum T_J allowed.
2. Derate design curve constrained by the maximum junction temperature ($T_J \leq 175^\circ\text{C}$) and power rating specified. (See 1.3 herein.)
3. Derate design curve chosen at $T_J \leq 150^\circ\text{C}$, where the maximum temperature of electrical test is performed.
4. Derate design curves chosen at $T_J \leq 125^\circ\text{C}$, and 110°C to show power rating where most users want to limit T_J in their application.

FIGURE 6. Temperature/power derating curve.

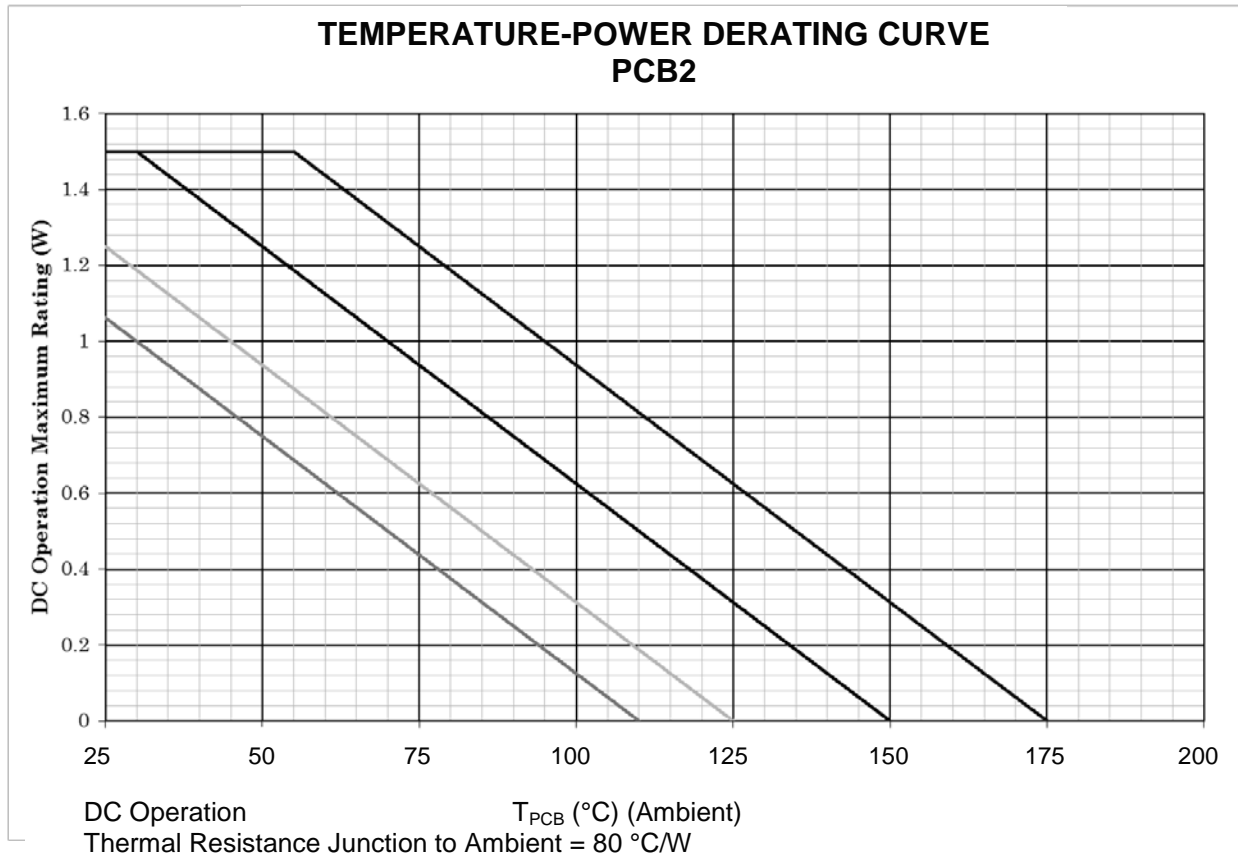

NOTES:

1. All devices are capable of operating at $\leq T_J$ specified on this curve. Any parallel line to this curve will intersect the appropriate power for the desired maximum T_J allowed.
2. Derate design curve constrained by the maximum junction temperature ($T_J \leq 175^\circ\text{C}$) and power rating specified. (See 1.3 herein.)
3. Derate design curve chosen at $T_J \leq 150^\circ\text{C}$, where the maximum temperature of electrical test is performed.
4. Derate design curves chosen at $T_J \leq 125^\circ\text{C}$, and 110°C to show power rating where most users want to limit T_J in their application.

FIGURE 7. Temperature/power derating curve.

Temperature-Power Derating Curve

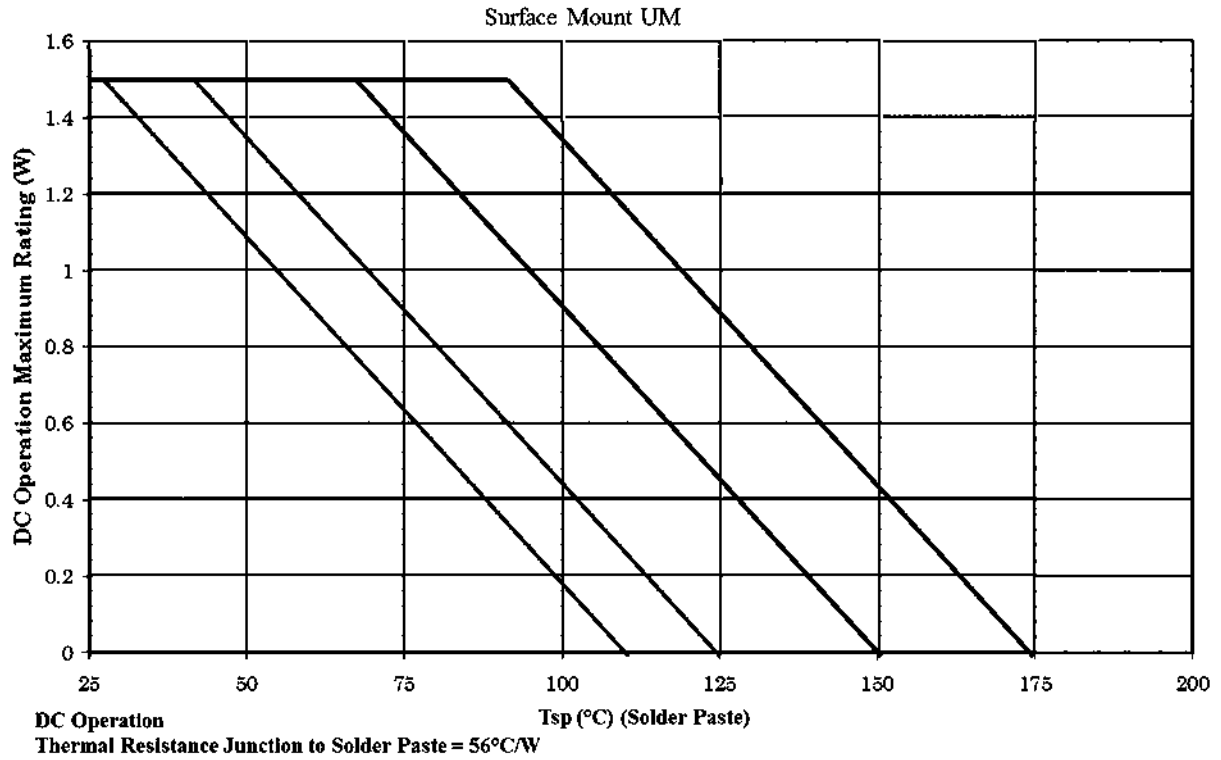

NOTES:

1. All devices are capable of operating at $\leq T_J$ specified on this curve. Any parallel line to this curve will intersect the appropriate power for the desired maximum T_J allowed.
2. Derate design curve constrained by the maximum junction temperature ($T_J \leq 175^\circ\text{C}$) and power rating specified. (See 1.3 herein.)
3. Derate design curve chosen at $T_J \leq 150^\circ\text{C}$, where the maximum temperature of electrical test is performed.
4. Derate design curves chosen at $T_J \leq 125^\circ\text{C}$, and 110°C to show power rating where most users want to limit T_J in their application.

* FIGURE 8. Temperature/power derating curve.

MIL-PRF-19500/406K
w/AMENDMENT 2

THERMAL IMPEDANCE CURVE
1N6485 THROUGH 1N6491 AND 1N4460 THROUGH 1N4461

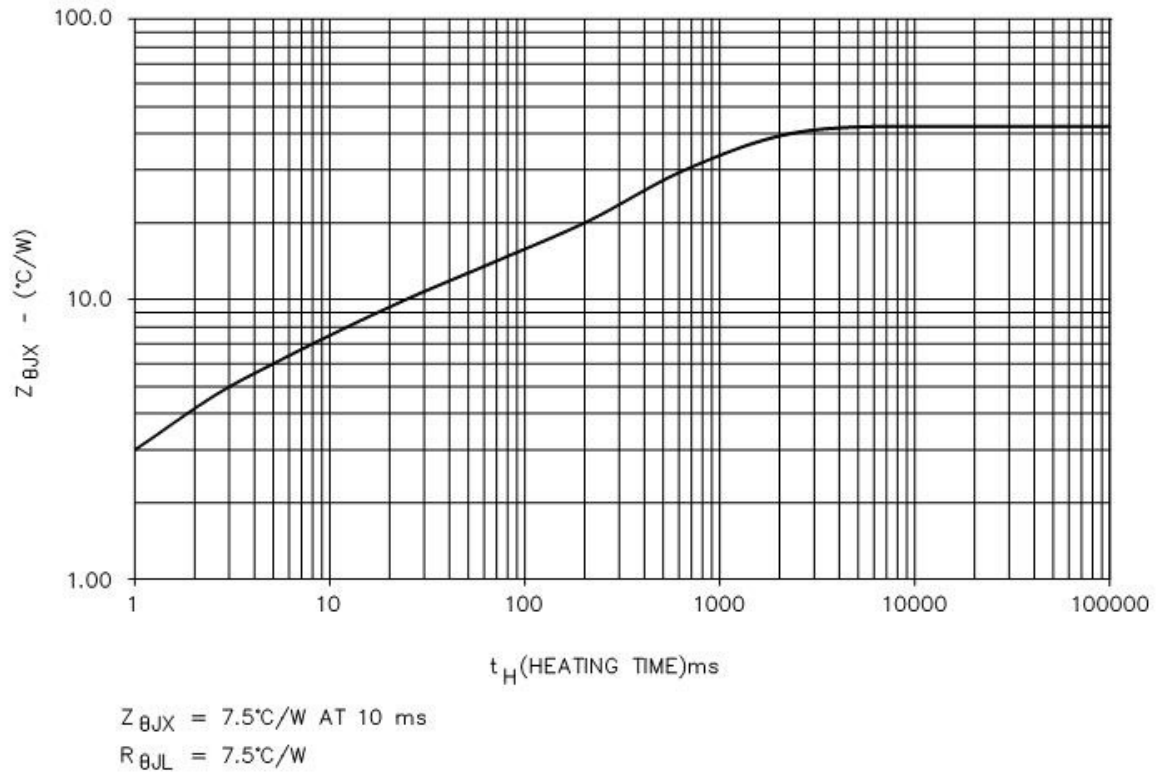
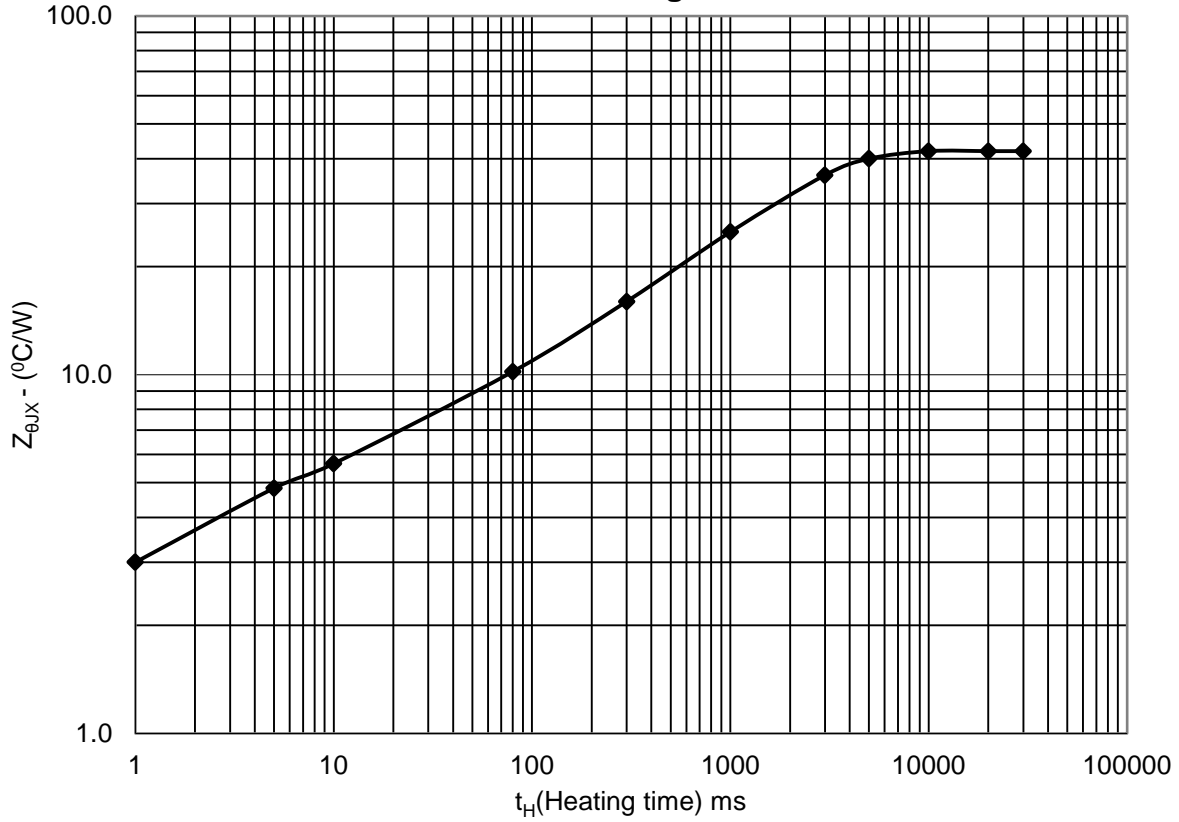

FIGURE 9. Thermal impedance curve for 1N6485 through 1N6491 and 1N4460 through 1N4461.

Thermal Impedance Curve 1N4462 through 1N4496



$Z_{\theta JX} = 5.7^{\circ}\text{C/W}$ at 10 ms

$R_{\theta JL} = 42^{\circ}\text{C/W}$

FIGURE 10. Thermal impedance curve for 1N4462 through 1N4496.

Thermal Impedance Curve
1N6485US through 1N6491US and 1N4460US through 1N4461US

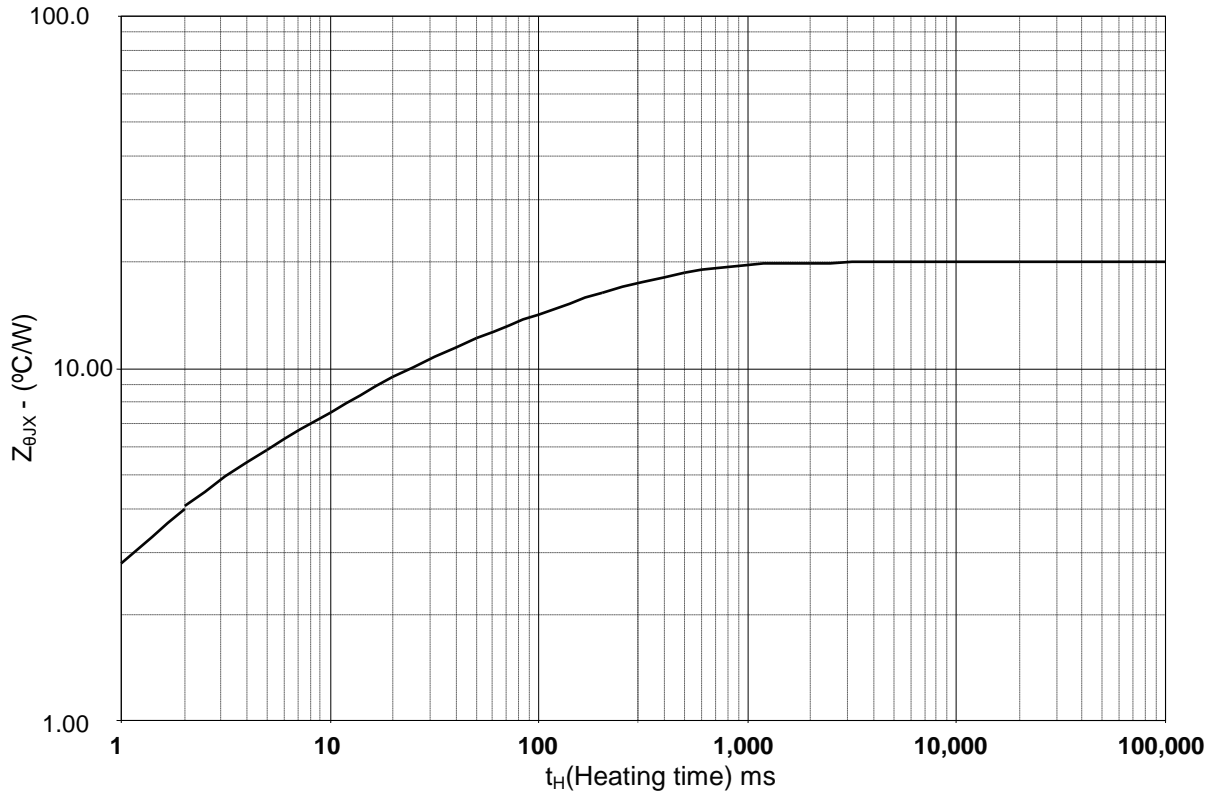

$Z_{\theta JX} = 7.5^{\circ}\text{C/W}$ at 10 ms

$R_{\theta JEC} = 20^{\circ}\text{C/W}$

FIGURE 11. Thermal impedance curve for 1N6485US through 1N6491US and 1N4460US through 1N4461US.

Thermal Impedance Curve 1N4462US through 1N4496US

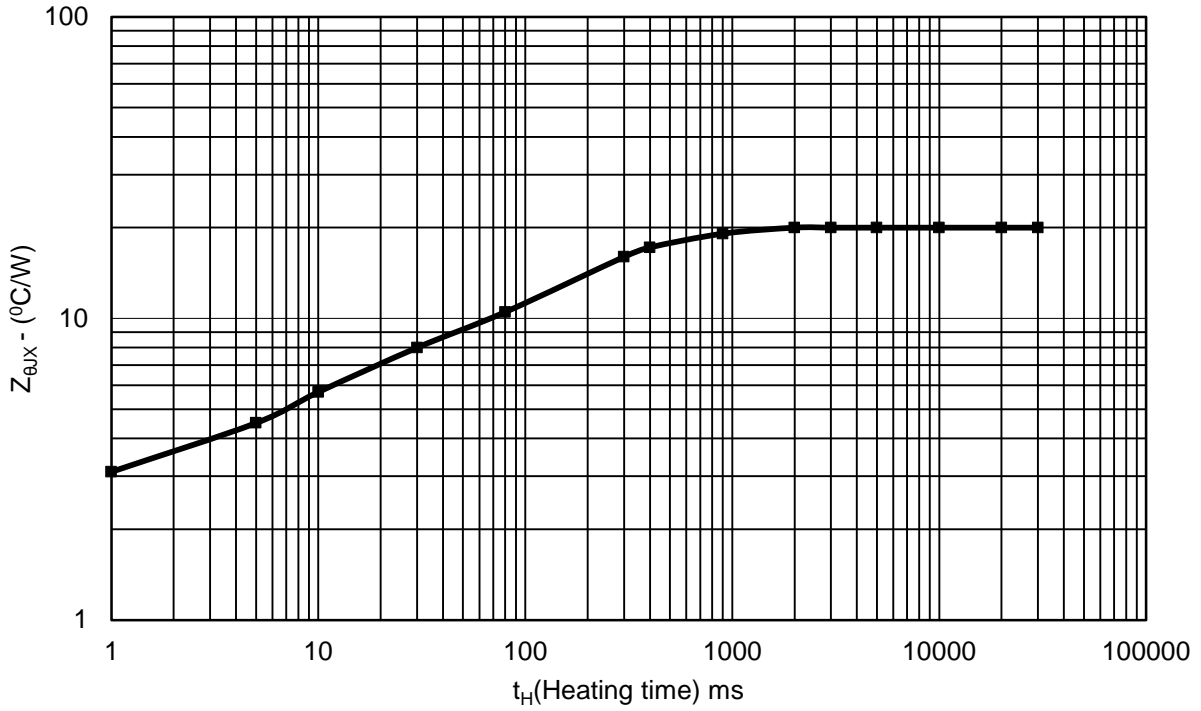

$Z_{\theta JX} = 5.7^{\circ}C/W$ at 10 ms

$R_{\theta JL} = 20^{\circ}C/W$

FIGURE 12. Thermal impedance curve for 1N4462US through 1N4496US.

Thermal Impedance Curve 1N4462UM through 1N4496UM

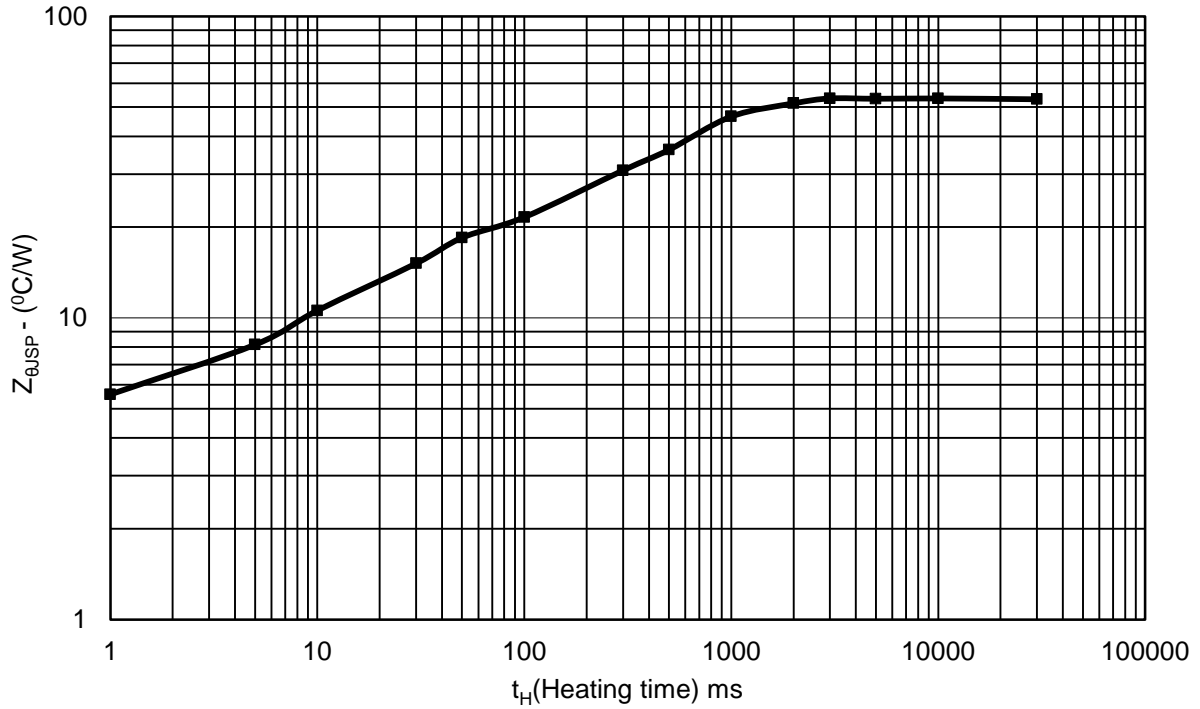

$Z_{\theta JSP} = 10.6 \text{ } ^\circ\text{C/W}$ at 10 ms

$R_{\theta JSP} = 56 \text{ } ^\circ\text{C/W}$

NOTE:

1. Curve achieved using 4 in^2 (101.6 mm^2) mounting pad of 2 ounce copper foil.

FIGURE 13. Thermal impedance curve for 1N4462UM through 1N4496UM.

MIL-PRF-19500/406K
w/AMENDMENT 2

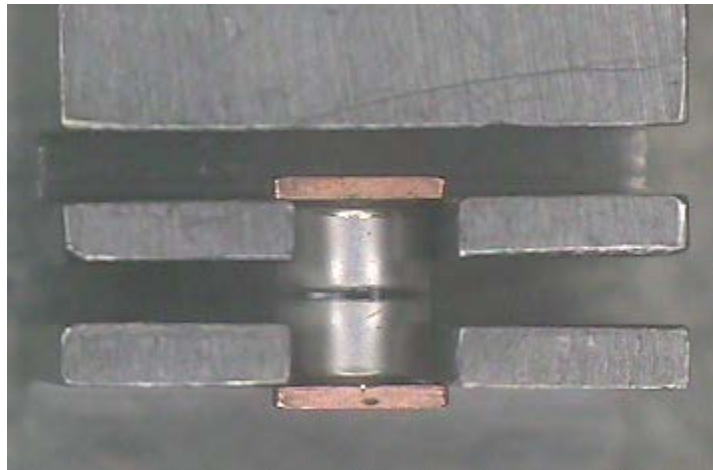
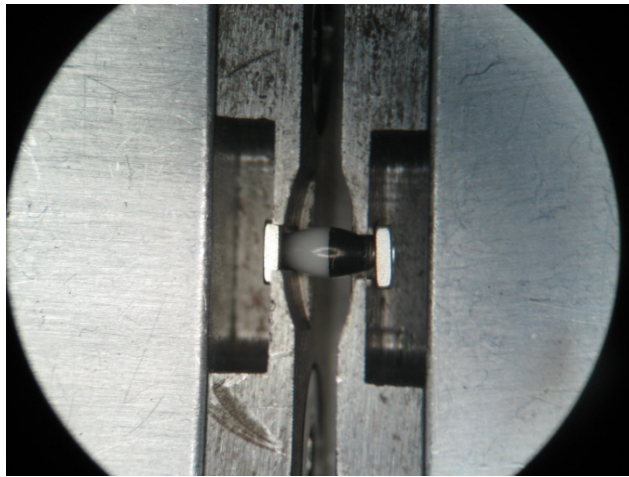

FIGURE 14. US terminal strength mounting.

5. PACKAGING

5.1 Packaging. For acquisition purposes, the packaging requirements shall be as specified in the contract or order (see 6.2). When packaging of materiel is to be performed by DoD or in-house contractor personnel, these personnel need to contact the responsible packaging activity to ascertain packaging requirements. Packaging requirements are maintained by the Inventory Control Point's packaging activities within the Military Service or Defense Agency, or within the Military Service's system commands. Packaging data retrieval is available from the managing Military Department's or Defense Agency's automated packaging files, CD-ROM products, or by contacting the responsible packaging activity.

6. NOTES

(This section contains information of a general or explanatory nature that may be helpful, but is not mandatory. The notes specified in MIL-PRF-19500 are applicable to this specification.)

6.1 Intended use. Semiconductors conforming to this specification are intended for original equipment design applications and logistic support of existing equipment.

6.2 Acquisition requirements. Acquisition documents should specify the following:

- a. Title, number, and date of this specification.
- b. Packaging requirements (see 5.1).
- c. Lead finish (see 3.6).
- d. Product assurance level and type designator.

6.3 Qualification. With respect to products requiring qualification, awards will be made only for products which are, at the time of award of contract, qualified for inclusion in Qualified Manufacturers List (QML 19500) whether or not such products have actually been so listed by that date. The attention of the contractors is called to these requirements, and manufacturers are urged to arrange to have the products that they propose to offer to the Federal Government tested for qualification in order that they may be eligible to be awarded contracts or orders for the products covered by this specification. Information pertaining to qualification of products may be obtained from DLA Land and Maritime, VQE, P.O. Box 3990, Columbus, OH 43218-3990 or e-mail vqe.chief@dla.mil. An online listing of products qualified to this specification may be found in the Qualified Products Database (QPD) at <https://assist.dla.mil>.

6.4 Applications data.

6.4.1 PCB (PCB1) mounting with FR4 material for only 0.6 W. For a printed board mounting example with FR4 base material where only 0.6 watts of power is used as shown on [figure 6](#) with 200°C/W thermal resistance junction to ambient at a T_J of 175°C and ambient temperature of 55°C, the following steps guide the user in what the printed board copper mounting pad size will need to be in area for each pad with 1 ounce, 2 ounce, and 3 ounce copper. For axial-leaded, the lead length for mounting will be .187 inch (4.75 mm) or less from body to entry point on PCB surface.

- a. Look up thermal resistance value of the required 200°C/W on the Y-axis using a thermal resistance versus copper mounting pad area plot on each of the three curves on [figure 15](#) for different weights of copper foil and then intersect curve horizontally to get the answer. These curves assume still air and horizontal printed board position.
- b. In this example, the copper mounting pad sizes for the different copper foil weights would be as follows:
 - (1) .0085 in² (0.216 mm²) for 1 ounce copper foil.
 - (2) .0050 in² (0.127 mm²) for 2 ounce copper foil.
 - (3) .0032 in² (0.081 mm²) for 3 ounce copper foil.
- c. Add a conservative guard-band to the copper mounting pad size (larger) to keep T_J below 175°C.

6.4.2 PCB (PCB2) mounting with FR4 material for the full 1.5 W. For a printed board mounting example with FR4 base material where the full 1.5 watt power rating is used as shown on [figure 7](#) with 80°C/W thermal resistance junction to ambient at a T_J of 175°C and ambient temperature of 55°C, the following steps guide the user in what the printed board copper mounting pad size will need to be in area for each pad with 1 ounce, 2 ounce, and 3 ounce copper. For axial-leaded, the lead length for mounting will be .187 inch (4.75 mm) or less from body to entry point on PCB surface.

- a. Look up thermal resistance value of the required 80°C/W on the Y-axis using a thermal resistance versus copper mounting pad area plot on each of the three curves on [figure 15](#) for different weights of copper foil and then intersect curve horizontally to get the answer. These curves assume still air and horizontal printed board position.
- b. In this example the copper mounting pad sizes for the different copper foil weights would be as follows:
 - (1) .20 in² (5.1 mm²) for 1 ounce copper foil.
 - (2) .12 in² (3.1 mm²) for 2 ounce copper foil.
 - (3) .08 in² (2.0 mm²) for 3 ounce copper foil.
- c. Add a conservative guard-band to the copper mounting pad size (larger) to keep T_J below 175°C.

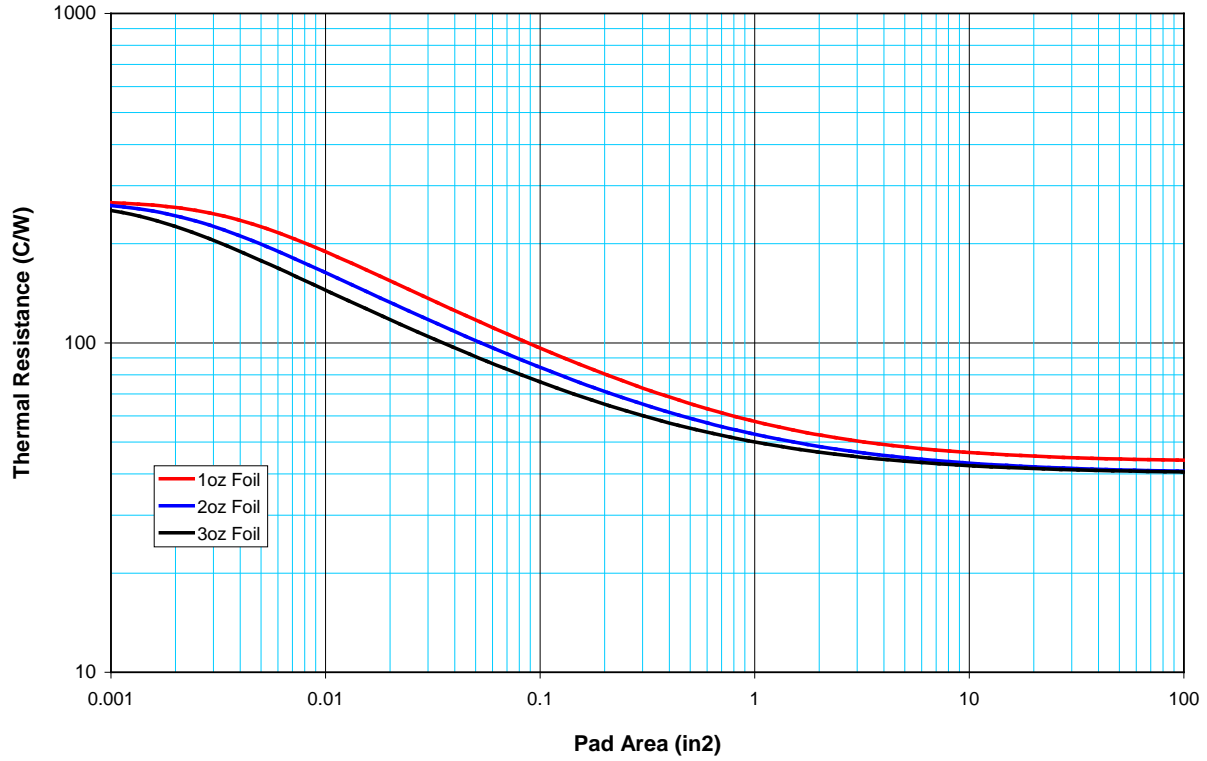

NOTE:

1. See figure 13 for UM package.

FIGURE 15. Thermal resistance versus FR4 pad area still air, PCB horizontal (for each pad) with 1 oz copper (top curve), 2 oz copper (middle curve), and 3 oz copper (bottom curve).

MIL-PRF-19500/406K
w/AMENDMENT 2

6.5 Amendment notations. The margins of this specification are marked with asterisks to indicate modifications generated by this amendment. This was done as a convenience only and the Government assumes no liability whatsoever for any inaccuracies in these notations. Bidders and contractors are cautioned to evaluate the requirements of this document based on the entire content irrespective of the marginal notations and relationship to the last previous issue.

Custodians:

Army - CR
Navy - EC
Air Force - 85
NASA - NA
DLA - CC

Preparing activity:

DLA - CC
(Project 5961-2013-028)

Review activities:

Army - AR, MI, SM
Navy - AS, MC
Air Force - 19

NOTE: The activities listed above were interested in this document as of the date of this document. Since organizations and responsibilities can change, you should verify the currency of the information above using the ASSIST Online database at <https://assist.dla.mil>.