

LM108, LM108A
LM208, LM208A
LM308, LM308A

PRECISION OPERATIONAL AMPLIFIERS

The LM108/LM208/LM308 Series operational amplifiers provide high input impedance, low input offsets and temperature drifts, and low noise. These characteristics are made possible by use of a special Super Beta processing technology. This series of amplifiers is particularly useful for applications where high-accuracy and low-drift performance are essential. In addition high-speed performance may be improved by employing feed-forward compensation techniques to maximize slew rate without compromising other performance criteria.

The LM108A/LM208A/LM308A Series offers extremely low input offset voltage and drift specifications allowing usage in even the most critical applications without external offset nulling.

- Operation From a Wide Range of Power Supply Voltages
- Low Input Bias and Offset Currents
- Low Input Offset Voltage and Guaranteed Offset Voltage Drift Performance
- High Input Impedance

SUPER GAIN
OPERATIONAL AMPLIFIERS

SILICON MONOLITHIC
INTEGRATED CIRCUIT

H SUFFIX
METAL PACKAGE
CASE 601

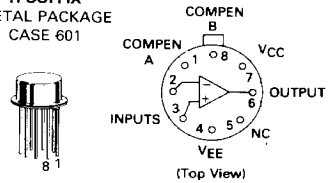

J SUFFIX
CERAMIC PACKAGE
CASE 632

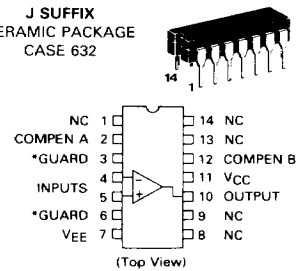

N SUFFIX
PLASTIC PACKAGE
CASE 626
(LM208, LM208A)
(LM308, LM308A Only)



J-8 SUFFIX
CERAMIC PACKAGE
CASE 693



D SUFFIX
PLASTIC PACKAGE
CASE 751
(SO-8)

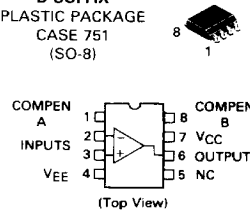

*Unused pin (no internal connection) to allow for input anti-leakage guard ring on printed circuit board layout.

FREQUENCY COMPENSATION

Standard Compensation

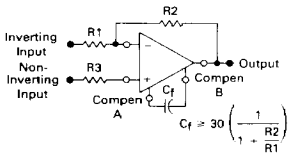

Modified Compensation

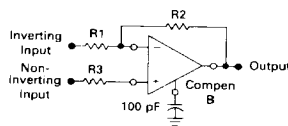

Standard Feedforward Compensation

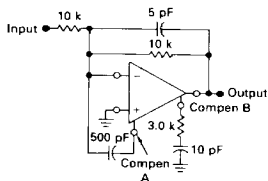

Feedforward Compensations for Decoupling Load Capacitance

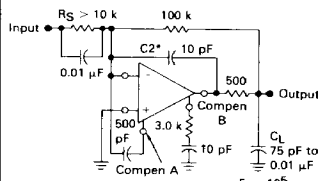

ORDERING INFORMATION

Device	Temperature Range	Package
LM108AH, H LM108AJ, J, AJ-8, J-8	-55 to +125°C	Metal Can Ceramic DIP
LM208AH, H LM208AJ, J, AJ-8, J-8 LM208AN, N LM208AD, D	-25 to -85°C	Metal Can Ceramic DIP Plastic DIP SO-8
LM308H, H LM308AJ, J, AJ-8, J-8 LM308AN, N LM308AD, D	0 to +70°C	Metal Can Ceramic DIP Plastic DIP SO-8

LM108, LM108A, LM208, LM208A, LM308, LM308A

MAXIMUM RATINGS (T_A = +25°C unless otherwise noted.)

Rating	Symbol	Value			Unit
		LM108, LM108A	LM208, LM208A	LM308, LM308A	
Power Supply Voltage	V _{CC} , V _{EE}	± 20	± 20	± 18	Vdc
Input Voltage (See Note 1)	V _I	← ± 15 →			Volts
Input Differential Current (See Note 2)	I _{ID}	← ± 10 →			mA
Output Short-Circuit Duration	t _S	← Indefinite →			
Operating Ambient Temperature Range	T _A	-55 to +125	-25 to +85	0 to +70	°C
Storage Temperature Range	T _{stg}	← -65 to +150 →			°C
Junction Temperature Metal, Ceramic Package	T _J	← +175 →			°C
Plastic Package		← +150 →			

Note 1. For supply voltages less than ±15 V, the maximum input voltage is equal to the supply voltage.

Note 2. The inputs are shunted with back-to-back diodes for over-voltage protection. Therefore, excessive current will flow if a differential input voltage in excess of 1.0 V is applied between the inputs unless some limiting resistance is used.

ELECTRICAL CHARACTERISTICS (Unless otherwise noted these specifications apply for supply voltages of +5.0 V ≤ V_{CC} ≤ +20 V and -5.0 V ≥ V_{EE} ≥ -20 V, T_A = +25°C.)

Characteristic	Symbol	LM108A LM208A			LM108 LM208			Unit
		Min	Typ	Max	Min	Typ	Max	
Input Offset Voltage	V _{IO}	—	0.3	0.5	—	0.7	2.0	mV
Input Offset Current	I _{IO}	—	0.05	0.2	—	0.005	0.2	nA
Input Bias Current	I _{IB}	—	0.8	2.0	—	0.8	2.0	nA
Input Resistance	r _i	30	70	—	30	70	—	Megohms
Power Supply Currents V _{CC} = +20 V, V _{EE} = -20 V	I _{CC} , I _{EE}	—	± 0.3	± 0.6	—	± 0.3	± 0.6	mA
Large Signal Voltage Gain V _{CC} = V _{EE} = +15 V, V _O = ±10 V, R _L ≥ 10 kΩ	A _{VOL}	80	300	—	50	300	—	V/mV

The following specifications apply over the operating temperature range.

Input Offset Voltage	V _{IO}	—	—	1.0	—	—	3.0	mV
Input Offset Current	I _{IO}	—	—	0.4	—	—	0.4	nA
Average Temperature Coefficient of Input Offset Voltage T _A (min) ≤ T _A ≤ T _A (max)	ΔV _{IO} /ΔT	—	1.0	5.0	—	3.0	15	μV/°C
Average Temperature Coefficient of Input Offset Current	ΔI _{IO} /ΔT	—	0.5	2.5	—	0.5	2.5	pA/°C
Input Bias Current	I _{IB}	—	—	3.0	—	—	3.0	nA
Large Signal Voltage Gain V _{CC} = V _{EE} = +15 V, V _O = ±10 V, R _L = 10 kΩ	A _{VOL}	40	—	—	25	—	—	V/mV
Input Voltage Range V _{CC} = V _{EE} = +15 V	V _{IR}	±13.5	—	—	±13.5	—	—	V
Common-Mode Rejection Ratio	CMRR	96	110	—	85	100	—	dB
Power Supply Voltage Rejection Ratio	PSRR	96	100	—	80	96	—	dB
Output Voltage Range V _{CC} = V _{EE} = +15 V, R _L = 10 kΩ	V _{OR}	± 13	± 14	—	± 13	± 14	—	V
Supply Current (T _A = T _A (max))	I _{CC} , I _{EE}	—	± 0.15	± 0.4	—	± 0.15	± 0.4	mA

LM108, LM108A, LM208, LM208A, LM308, LM308A

ELECTRICAL CHARACTERISTICS (Unless otherwise noted these specifications apply for supply voltages of $+5.0\text{ V} \leq V_{CC} \leq +15\text{ V}$ and $-5.0\text{ V} \geq V_{EE} \geq -15\text{ V}$, $T_A = +25^\circ\text{C}$.)

Characteristic	Symbol	LM308A			LM308			Unit
		Min	Typ	Max	Min	Typ	Max	
Input Offset Voltage	V_{IO}	—	0.3	0.5	—	2.0	7.5	mV
Input Offset Current	I_{IO}	—	0.2	1.0	—	0.2	1.0	nA
Input Bias Current	I_{IB}	—	1.5	7.0	—	1.5	7.0	nA
Input Resistance	r_i	10	40	—	10	40	—	Megohms
Power Supply Currents $V_{CC} = +15\text{ V}$, $V_{EE} = -15\text{ V}$	I_{CC}, I_{EE}	—	± 0.3	± 0.8	—	± 0.3	± 0.8	mA
Large Signal Voltage Gain $V_{CC} = +15\text{ V}$, $V_{EE} = -15\text{ V}$, $V_O = \pm 10\text{ V}$, $R_L \geq 10\text{ k}\Omega$	A_{VOL}	80	300	—	25	300	—	V/mV

The following specifications apply over the operating temperature range.

Input Offset Voltage	V_{IO}	—	—	0.73	—	—	10	mV
Input Offset Current	I_{IO}	—	—	1.5	—	—	1.5	nA
Average Temperature Coefficient of Input Offset Voltage $T_A(\text{min}) \leq T_A \leq T_A(\text{max})$	$\Delta V_{IO}/\Delta T$	—	1.0	5.0	—	6.0	30	$\mu\text{V}/^\circ\text{C}$
Average Temperature Coefficient of Input Offset Current	$\Delta I_{IO}/\Delta T$	—	2.0	10	—	2.0	10	$\mu\text{A}/^\circ\text{C}$
Input Bias Current	I_{IB}	—	—	10	—	—	10	nA
Large Signal Voltage Gain $V_{CC} = +15\text{ V}$, $V_{EE} = -15\text{ V}$, $V_O = \pm 10\text{ V}$, $R_L \geq 10\text{ k}\Omega$	A_{VOL}	60	—	—	15	—	—	V/mV
Input Voltage Range $V_{CC} = +15\text{ V}$, $V_{EE} = -15\text{ V}$	V_{IR}	± 14	—	—	± 14	—	—	V
Common-Mode Rejection Ratio $R_S \leq 50\text{ k}\Omega$	CMRR	96	110	—	80	100	—	dB
Supply Voltage Rejection Ratio $R_S \leq 50\text{ k}\Omega$	PSRR	96	110	—	80	96	—	dB
Output Voltage Range $V_{CC} = +15\text{ V}$, $V_{EE} = -15\text{ V}$, $R_L = 10\text{ k}\Omega$	V_{OR}	± 13	± 14	—	± 13	± 14	—	V

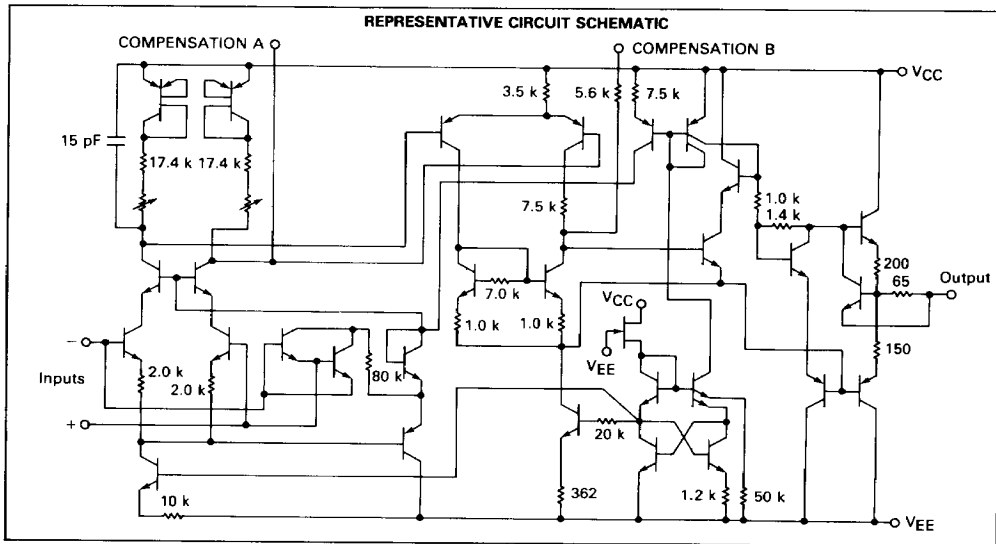

LM108, LM108A, LM208, LM208A, LM308, LM308A

TYPICAL CHARACTERISTICS

FIGURE 1 – INPUT BIAS AND INPUT OFFSET CURRENTS

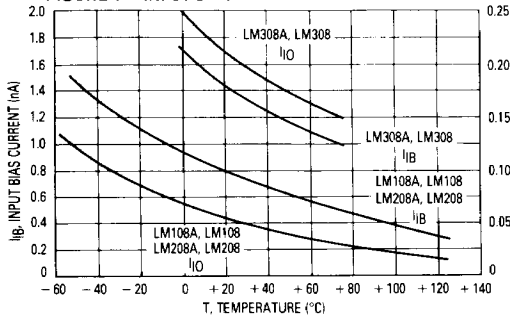

FIGURE 2 – MAXIMUM EQUIVALENT INPUT OFFSET VOLTAGE ERROR versus INPUT RESISTANCE

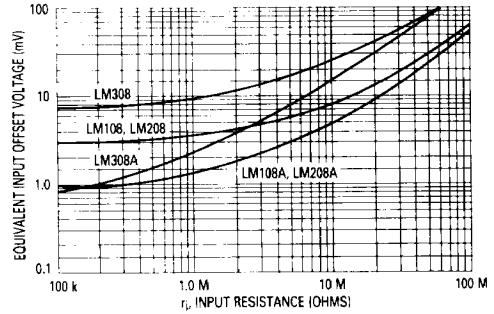

FIGURE 3 – VOLTAGE GAIN versus SUPPLY VOLTAGES

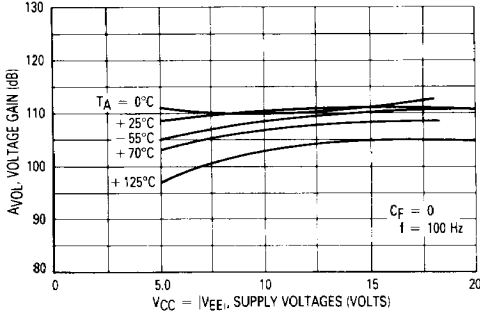

FIGURE 4 – POWER SUPPLY CURRENTS versus POWER SUPPLY VOLTAGE

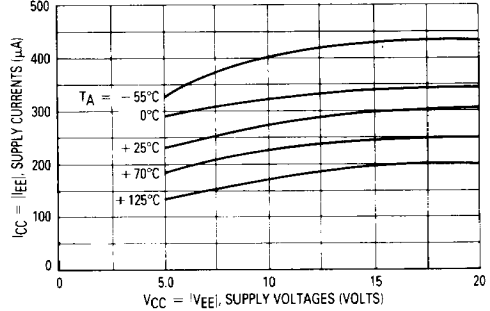

FIGURE 5 – OPEN-LOOP FREQUENCY RESPONSE

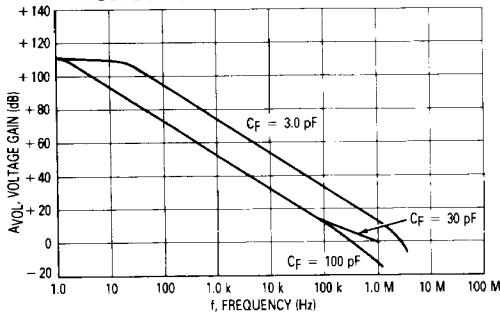
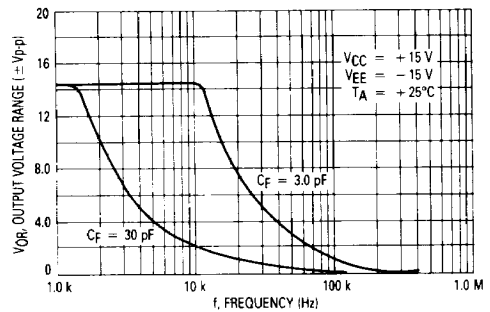

FIGURE 6 – LARGE-SIGNAL FREQUENCY RESPONSE



LM140,A, LM340,A

LM140A/340A — 5.0

ELECTRICAL CHARACTERISTICS ($V_{in} = 10\text{ V}$, $I_O = 1.0\text{ A}$, $T_J = T_{low}$ to T_{high} (Note 1), unless otherwise noted).

Characteristic	Symbol	Min	Typ	Max	Unit
Output Voltage ($T_J = +25^\circ\text{C}$) $I_O = 5.0\text{ mA}$ to 1.0 A	V_O	4.9	5.0	5.1	Vdc
Line Regulation (Note 2) 7.5 to 20 Vdc, $I_O = 500\text{ mA}$ 7.3 to 20 Vdc ($T_J = +25^\circ\text{C}$) 8.0 to 12 Vdc 8.0 to 12 Vdc ($T_J = +25^\circ\text{C}$)	Reg _{line}	—	— 3.0	10 10 12 4.0	mV
Load Regulation (Note 2) $5.0\text{ mA} \leq I_O \leq 1.0\text{ A}$ $5.0\text{ mA} \leq I_O \leq 1.5\text{ A}$ ($T_J = +25^\circ\text{C}$) $250\text{ mA} \leq I_O \leq 750\text{ mA}$ ($T_J = +25^\circ\text{C}$)	Reg _{load}	—	—	25 25 15	mV
Output Voltage $7.5 \leq V_{in} \leq 20\text{ Vdc}$, $5.0\text{ mA} \leq I_O \leq 1.0\text{ A}$, $P_D \leq 15\text{ W}$	V_O	4.8	—	5.2	Vdc
Quiescent Current ($T_J = +25^\circ\text{C}$)	I_B	—	— 3.5	6.5 6.0	mA
Quiescent Current Change $5.0\text{ mA} \leq I_O \leq 1.0\text{ A}$, $V_{in} = 10\text{ V}$ $8.0 \leq V_{in} \leq 25\text{ Vdc}$, $I_O = 500\text{ mA}$ $7.5 \leq V_{in} \leq 20\text{ Vdc}$, $I_O = 1.0\text{ A}$ ($T_J = +25^\circ\text{C}$)	ΔI_B	—	—	0.5 0.8 0.8	mA
Ripple Rejection $8.0 \leq V_{in} \leq 18\text{ Vdc}$, $f = 120\text{ Hz}$ $I_O = 500\text{ mA}$ $I_O = 1.0\text{ A}$ ($T_J = +25^\circ\text{C}$)	RR	—	— 68 68	— — 80	dB
Dropout Voltage	$V_{in} - V_O$	—	1.7	—	Vdc
Output Resistance ($f = 1.0\text{ kHz}$)	r_O	—	2.0	—	$\text{m}\Omega$
Short-Circuit Current Limit ($T_J = +25^\circ\text{C}$)	I_{sc}	—	2.0	—	mA
Output Noise Voltage ($T_A = +25^\circ\text{C}$) $10\text{ Hz} \leq f \leq 100\text{ kHz}$	V_n	—	40	—	μV
Average Temperature Coefficient of Output Voltage $I_O = 5.0\text{ mA}$	TCV_O	—	± 0.6	—	$\text{mV}/^\circ\text{C}$
Peak Output Current ($T_J = +25^\circ\text{C}$)	I_O	—	2.4	—	A
Input Voltage to Maintain Line Regulation ($T_J = +25^\circ\text{C}$)		7.3	—	—	Vdc

NOTES:

- $T_{low} = -55^\circ\text{C}$ for LM140A $T_{high} = +150^\circ\text{C}$ for LM140A
 $\quad = 0^\circ\text{C}$ for LM340A $\quad = +125^\circ\text{C}$ for LM340A
- Load and line regulation are specified at constant junction temperature. Changes in V_O due to heating effects must be taken into account separately. Pulse testing with low duty cycle is used.

3