



3

Three-Terminal Positive Voltage Regulators

These voltage regulators are monolithic integrated circuits designed as fixed-voltage regulators for a wide variety of applications including local, on-card regulation. These regulators employ internal current limiting, thermal shutdown, and safe-area compensation. With adequate heatsinking they can deliver output currents in excess of 1.0 A. Although designed primarily as a fixed voltage regulator, these devices can be used with external components to obtain adjustable voltages and currents.

- Output Current in Excess of 1.0 A
- No External Components Required
- Internal Thermal Overload Protection
- Internal Short Circuit Current Limiting
- Output Transistor Safe-Area Compensation
- Output Voltage Offered in 2% and 4% Tolerance
- Available in Surface Mount D²PAK and Standard 3-Lead Transistor Packages

MC7800 Series

THREE-TERMINAL POSITIVE FIXED VOLTAGE REGULATORS

SEMICONDUCTOR TECHNICAL DATA

T SUFFIX
PLASTIC PACKAGE
CASE 221A

Heatsink surface connected to Pin 2.

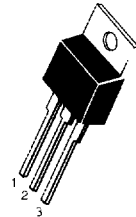

Pin 1. Input
2. Ground
3. Output

D2T SUFFIX
PLASTIC PACKAGE
CASE 936
(D²PAK)

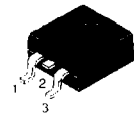

Heatsink surface (shown as terminal 4 in case outline drawing) is connected to Pin 2.

DEVICE TYPE/NOMINAL OUTPUT VOLTAGE

MC7805	5.0 V	MC7812	12 V
MC7806	6.0 V	MC7815	15 V
MC7808	8.0 V	MC7818	18 V
MC7809	9.0 V	MC7824	24 V

ORDERING INFORMATION

Device	Output Voltage Tolerance	Operating Temperature Range	Package
MC78XXACT	2%	T _J = 0° to +125 C	Insertion Mount
MC78XXACD2T			Surface Mount
MC78XXCT	4%		Insertion Mount
MC78XXCD2T			Surface Mount
MC78XXBT	4%	T _J = -40° to +125 C	Insertion Mount
MC78XXBD2T			Surface Mount

XX indicates nominal voltage.

STANDARD APPLICATION

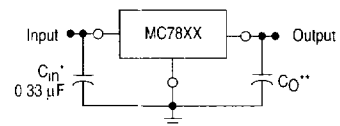

A common ground is required between the input and the output voltages. The input voltage must remain typically 2.0 V above the output voltage even during the low point on the input ripple voltage.

XX. These two digits of the type number indicate nominal voltage.

* C_{IN} is required if regulator is located an appreciable distance from power supply filter.

** C_O is not needed for stability; however, it does improve transient response. Values of less than 0.1 μF could cause instability.

MC7800 Series

MAXIMUM RATINGS ($T_A = 25^\circ\text{C}$ unless otherwise noted.)

Rating	Symbol	Value	Unit
Input Voltage (5.0 – 18 V) (24 V)	V_I	35	Vdc
		40	
Power Dissipation Case 221A $T_A = 25^\circ\text{C}$ Thermal Resistance, Junction-to-Ambient Thermal Resistance, Junction-to-Case Case 936 (D ² PAK) $T_A = 25^\circ\text{C}$ Thermal Resistance, Junction-to-Ambient Thermal Resistance, Junction-to-Case	P_D	Internally Limited	W
	$R_{\theta JA}$	65	$^\circ\text{C/W}$
	$R_{\theta JC}$	5.0	$^\circ\text{C/W}$
	P_D	Internally Limited	W
	$R_{\theta JA}$	See Figure 13	$^\circ\text{C/W}$
	$R_{\theta JA}$	5.0	$^\circ\text{C/W}$
Storage Junction Temperature Range	T_{stg}	-65 to +150	$^\circ\text{C}$
Operating Junction Temperature	T_J	+150	$^\circ\text{C}$

3

Representative Schematic Diagram

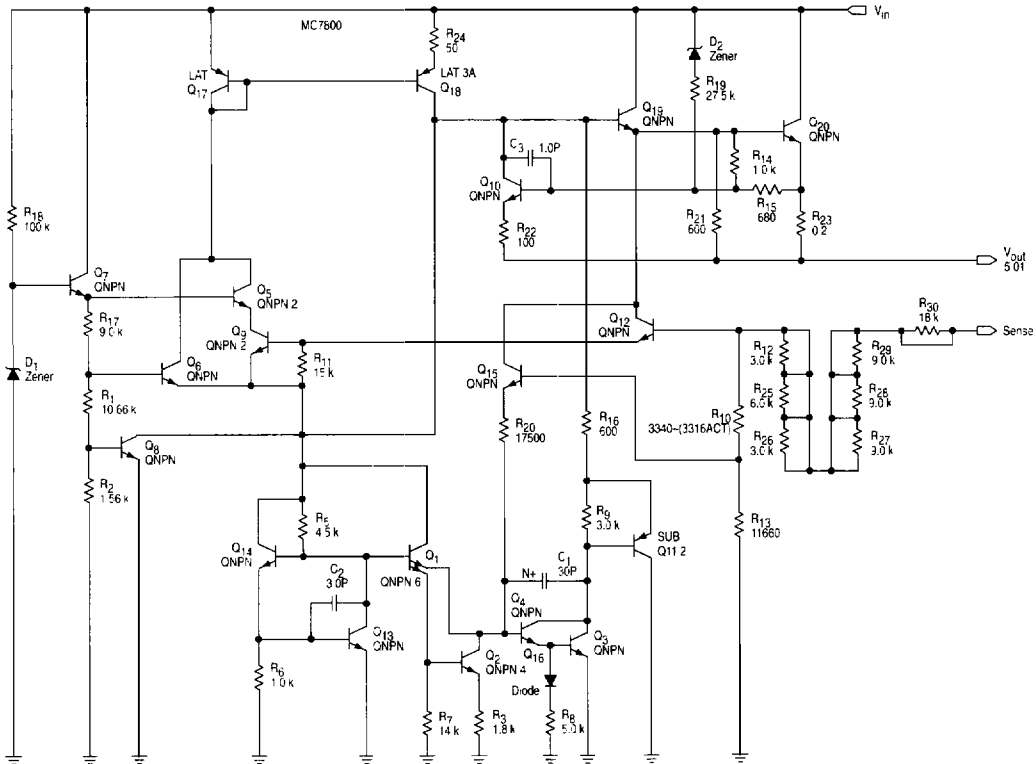

This device contains 22 active transistors.

MC7800 Series

ELECTRICAL CHARACTERISTICS ($V_{in} = 10\text{ V}$, $I_O = 500\text{ mA}$, $T_J = T_{low}$ to T_{high} [Note 1], unless otherwise noted.)

Characteristic	Symbol	MC7805B			MC7805C			Unit
		Min	Typ	Max	Min	Typ	Max	
Output Voltage ($T_J = 25^\circ\text{C}$)	V_O	4.8	5.0	5.2	4.8	5.0	5.2	Vdc
Output Voltage ($5.0\text{ mA} \leq I_O \leq 1.0\text{ A}$, $P_D \leq 15\text{ W}$) $7.0\text{ Vdc} \leq V_{in} \leq 20\text{ Vdc}$ $8.0\text{ Vdc} \leq V_{in} \leq 20\text{ Vdc}$	V_O	– 4.75	– 5.0	– 5.25	4.75 –	5.0 –	5.25 –	Vdc
Line Regulation, $T_J = 25^\circ\text{C}$ (Note 2) $7.0\text{ Vdc} \leq V_{in} \leq 25\text{ Vdc}$ $8.0\text{ Vdc} \leq V_{in} \leq 12\text{ Vdc}$	Reg _{line}	– –	5.0 1.3	100 50	– –	5.0 1.3	100 50	mV
Load Regulation, $T_J = 25^\circ\text{C}$ (Note 2) $5.0\text{ mA} \leq I_O \leq 1.5\text{ A}$ $250\text{ mA} \leq I_O \leq 750\text{ mA}$	Reg _{load}	– –	1.3 0.15	100 50	– –	1.3 0.15	100 50	mV
Quiescent Current ($T_J = 25^\circ\text{C}$)	I_B	–	3.2	8.0	–	3.2	8.0	mA
Quiescent Current Change $7.0\text{ Vdc} \leq V_{in} \leq 25\text{ Vdc}$ $8.0\text{ Vdc} \leq V_{in} \leq 25\text{ Vdc}$ $5.0\text{ mA} \leq I_O \leq 1.0\text{ A}$	ΔI_B	– – –	– – –	– 1.3 0.5	– – –	– – –	1.3 – 0.5	mA
Ripple Rejection $8.0\text{ Vdc} \leq V_{in} \leq 18\text{ Vdc}$, $f = 120\text{ Hz}$	RR	–	68	–	–	68	–	dB
Dropout Voltage ($I_O = 1.0\text{ A}$, $T_J = 25^\circ\text{C}$)	$V_I - V_O$	–	2.0	–	–	2.0	–	Vdc
Output Noise Voltage ($T_A = 25^\circ\text{C}$) $10\text{ Hz} \leq f \leq 100\text{ kHz}$	V_n	–	10	–	–	10	–	$\mu\text{V}/V_O$
Output Resistance $f = 1.0\text{ kHz}$	r_O	–	0.9	–	–	0.9	–	$\text{m}\Omega$
Short Circuit Current Limit ($T_A = 25^\circ\text{C}$) $V_{in} = 35\text{ Vdc}$	I_{SC}	–	0.2	–	–	0.2	–	A
Peak Output Current ($T_J = 25^\circ\text{C}$)	I_{max}	–	2.2	–	–	2.2	–	A
Average Temperature Coefficient of Output Voltage	TCV_O	–	–0.3	–	–	–0.3	–	$\text{mV}/^\circ\text{C}$

ELECTRICAL CHARACTERISTICS ($V_{in} = 10\text{ V}$, $I_O = 1.0\text{ A}$, $T_J = T_{low}$ to T_{high} [Note 1], unless otherwise noted.)

Characteristic	Symbol	MC7805AC			Unit
		Min	Typ	Max	
Output Voltage ($T_J = 25^\circ\text{C}$)	V_O	4.9	5.0	5.1	Vdc
Output Voltage ($5.0\text{ mA} \leq I_O \leq 1.0\text{ A}$, $P_D \leq 15\text{ W}$) $7.5\text{ Vdc} \leq V_{in} \leq 20\text{ Vdc}$	V_O	4.8	5.0	5.2	Vdc
Line Regulation (Note 2) $7.5\text{ Vdc} \leq V_{in} \leq 25\text{ Vdc}$, $I_O = 500\text{ mA}$ $8.0\text{ Vdc} \leq V_{in} \leq 12\text{ Vdc}$ $8.0\text{ Vdc} \leq V_{in} \leq 12\text{ Vdc}$, $T_J = 25^\circ\text{C}$ $7.3\text{ Vdc} \leq V_{in} \leq 20\text{ Vdc}$, $T_J = 25^\circ\text{C}$	Reg _{line}	– – – –	5.0 1.3 1.3 4.5	50 50 25 50	mV
Load Regulation (Note 2) $5.0\text{ mA} \leq I_O \leq 1.5\text{ A}$, $T_J = 25^\circ\text{C}$ $5.0\text{ mA} \leq I_O \leq 1.0\text{ A}$ $250\text{ mA} \leq I_O \leq 750\text{ mA}$	Reg _{load}	– – –	1.3 0.8 0.15	100 100 50	mV
Quiescent Current ($T_J = 25^\circ\text{C}$)	I_B	– –	– 3.2	6.0 6.0	mA
Quiescent Current Change $8.0\text{ Vdc} \leq V_{in} \leq 25\text{ Vdc}$, $I_O = 500\text{ mA}$ $7.5\text{ Vdc} \leq V_{in} \leq 20\text{ Vdc}$, $T_J = 25^\circ\text{C}$ $5.0\text{ mA} \leq I_O \leq 1.0\text{ A}$	ΔI_B	– – –	– – –	0.8 0.8 0.5	mA

NOTES: 1. $T_{low} = 0^\circ\text{C}$ for MC78XXAC, C $T_{high} = +125^\circ\text{C}$ for MC78XXAC, C, B
= -40°C for MC78XXB

2. Load and line regulation are specified at constant junction temperature. Changes in V_O due to heating effects must be taken into account separately. Pulse testing with low duty cycle is used.

MC7800 Series

ELECTRICAL CHARACTERISTICS (continued) ($V_{in} = 10\text{ V}$, $I_O = 1.0\text{ A}$, $T_J = T_{low}$ to T_{high} [Note 1], unless otherwise noted.)

Characteristic	Symbol	MC7805AC			Unit
		Min	Typ	Max	
Ripple Rejection $8.0\text{ Vdc} \leq V_{in} \leq 18\text{ Vdc}$, $f = 120\text{ Hz}$, $I_O = 500\text{ mA}$	RR	–	68	–	dB
Dropout Voltage ($I_O = 1.0\text{ A}$, $T_J = 25^\circ\text{C}$)	$V_I - V_O$	–	2.0	–	Vdc
Output Noise Voltage ($T_A = 25^\circ\text{C}$) $10\text{ Hz} \leq f \leq 100\text{ kHz}$	V_n	–	10	–	$\mu\text{V}/V_O$
Output Resistance ($f = 1.0\text{ kHz}$)	r_O	–	0.9	–	$\text{m}\Omega$
Short Circuit Current Limit ($T_A = 25^\circ\text{C}$) $V_{in} = 35\text{ Vdc}$	I_{SC}	–	0.2	–	A
Peak Output Current ($T_J = 25^\circ\text{C}$)	I_{max}	–	2.2	–	A
Average Temperature Coefficient of Output Voltage	TCV_O	–	–0.3	–	$\text{mV}/^\circ\text{C}$

3

ELECTRICAL CHARACTERISTICS ($V_{in} = 11\text{ V}$, $I_O = 500\text{ mA}$, $T_J = T_{low}$ to T_{high} [Note 1], unless otherwise noted.)

Characteristic	Symbol	MC7806B			MC7806C			Unit
		Min	Typ	Max	Min	Typ	Max	
Output Voltage ($T_J = 25^\circ\text{C}$)	V_O	5.75	6.0	6.25	5.75	6.0	6.25	Vdc
Output Voltage ($5.0\text{ mA} \leq I_O \leq 1.0\text{ A}$, $P_D \leq 15\text{ W}$) $8.0\text{ Vdc} \leq V_{in} \leq 21\text{ Vdc}$ $9.0\text{ Vdc} \leq V_{in} \leq 21\text{ Vdc}$	V_O	– 5.7	– 6.0	– 6.3	5.7 –	6.0 –	6.3 –	Vdc
Line Regulation, $T_J = 25^\circ\text{C}$ (Note 2) $8.0\text{ Vdc} \leq V_{in} \leq 25\text{ Vdc}$ $9.0\text{ Vdc} \leq V_{in} \leq 13\text{ Vdc}$	Reg _{line}	– –	5.5 1.4	120 60	– –	5.5 1.4	120 60	mV
Load Regulation, $T_J = 25^\circ\text{C}$ (Note 2) $5.0\text{ mA} \leq I_O \leq 1.5\text{ A}$ $250\text{ mA} \leq I_O \leq 750\text{ mA}$	Reg _{load}	– –	1.3 0.2	120 60	– –	1.3 0.2	120 60	mV
Quiescent Current ($T_J = 25^\circ\text{C}$)	I_B	–	3.3	8.0	–	3.3	8.0	mA
Quiescent Current Change $8.0\text{ Vdc} \leq V_{in} \leq 25\text{ Vdc}$ $9.0\text{ Vdc} \leq V_{in} \leq 25\text{ Vdc}$ $5.0\text{ mA} \leq I_O \leq 1.0\text{ A}$	ΔI_B	– – –	– – –	– 1.3 0.5	– – –	– – –	1.3 – 0.5	mA
Ripple Rejection $9.0\text{ Vdc} \leq V_{in} \leq 19\text{ Vdc}$, $f = 120\text{ Hz}$	RR	–	65	–	–	65	–	dB
Dropout Voltage ($I_O = 1.0\text{ A}$, $T_J = 25^\circ\text{C}$)	$V_I - V_O$	–	2.0	–	–	2.0	–	Vdc
Output Noise Voltage ($T_A = 25^\circ\text{C}$) $10\text{ Hz} \leq f \leq 100\text{ kHz}$	V_n	–	10	–	–	10	–	$\mu\text{V}/V_O$
Output Resistance $f = 1.0\text{ kHz}$	r_O	–	0.9	–	–	0.9	–	$\text{m}\Omega$
Short Circuit Current Limit ($T_A = 25^\circ\text{C}$) $V_{in} = 35\text{ Vdc}$	I_{SC}	–	0.2	–	–	0.2	–	A
Peak Output Current ($T_J = 25^\circ\text{C}$)	I_{max}	–	2.2	–	–	2.2	–	A
Average Temperature Coefficient of Output Voltage	TCV_O	–	–0.3	–	–	–0.3	–	$\text{mV}/^\circ\text{C}$

NOTES: 1. $T_{low} = 0^\circ\text{C}$ for MC78XXAC, C $T_{high} = +125^\circ\text{C}$ for MC78XXAC, C, B
= -40°C for MC78XXB

2. Load and line regulation are specified at constant junction temperature. Changes in V_O due to heating effects must be taken into account separately. Pulse testing with low duty cycle is used

MC7800 Series

ELECTRICAL CHARACTERISTICS ($V_{in} = 11\text{ V}$, $I_O = 1.0\text{ A}$, $T_J = T_{low}$ to T_{high} [Note 1], unless otherwise noted.)

Characteristic	Symbol	MC7806AC			Unit
		Min	Typ	Max	
Output Voltage ($T_J = 25^\circ\text{C}$)	V_O	5.88	6.0	6.12	Vdc
Output Voltage ($5.0\text{ mA} \leq I_O \leq 1.0\text{ A}$, $P_D \leq 15\text{ W}$) $8.6\text{ Vdc} \leq V_{in} \leq 21\text{ Vdc}$	V_O	5.76	6.0	6.24	Vdc
Line Regulation (Note 2) $8.6\text{ Vdc} \leq V_{in} \leq 25\text{ Vdc}$, $I_O = 500\text{ mA}$ $9.0\text{ Vdc} \leq V_{in} \leq 13\text{ Vdc}$ $9.0\text{ Vdc} \leq V_{in} \leq 13\text{ Vdc}$, $T_J = 25^\circ\text{C}$ $8.3\text{ Vdc} \leq V_{in} \leq 21\text{ Vdc}$, $T_J = 25^\circ\text{C}$	Regline	–	5.0 1.4 1.4 4.5	60 60 30 60	mV
Load Regulation (Note 2) $5.0\text{ mA} \leq I_O \leq 1.5\text{ A}$, $T_J = 25^\circ\text{C}$ $5.0\text{ mA} \leq I_O \leq 1.0\text{ A}$ $250\text{ mA} \leq I_O \leq 750\text{ mA}$	Regload	–	1.3 0.9 0.2	100 100 50	mV
Quiescent Current $T_J = 25^\circ\text{C}$	I_B	–	– 3.3	6.0 6.0	mA
Quiescent Current Change $9.0\text{ Vdc} \leq V_{in} \leq 25\text{ Vdc}$, $I_O = 500\text{ mA}$ $8.6\text{ Vdc} \leq V_{in} \leq 21\text{ Vdc}$, $T_J = 25^\circ\text{C}$ $5.0\text{ mA} \leq I_O \leq 1.0\text{ A}$	ΔI_B	–	–	0.8 0.8 0.5	mA
Ripple Rejection $9.0\text{ Vdc} \leq V_{in} \leq 19\text{ Vdc}$, $f = 120\text{ Hz}$, $I_O = 500\text{ mA}$	RR	–	65	–	dB
Dropout Voltage ($I_O = 1.0\text{ A}$, $T_J = 25^\circ\text{C}$)	$V_I - V_O$	–	2.0	–	Vdc
Output Noise Voltage ($T_A = 25^\circ\text{C}$) $10\text{ Hz} \leq f \leq 100\text{ kHz}$	V_n	–	10	–	$\mu\text{V}/V_O$
Output Resistance ($f = 1.0\text{ kHz}$)	r_O	–	0.9	–	$\text{m}\Omega$
Short Circuit Current Limit ($T_A = 25^\circ\text{C}$) $V_{in} = 35\text{ Vdc}$	I_{SC}	–	0.2	–	A
Peak Output Current ($T_J = 25^\circ\text{C}$)	I_{max}	–	2.2	–	A
Average Temperature Coefficient of Output Voltage	TCV_O	–	–0.3	–	$\text{mV}/^\circ\text{C}$

ELECTRICAL CHARACTERISTICS ($V_{in} = 14\text{ V}$, $I_O = 500\text{ mA}$, $T_J = T_{low}$ to T_{high} [Note 1], unless otherwise noted.)

Characteristic	Symbol	MC7808B			MC7808C			Unit
		Min	Typ	Max	Min	Typ	Max	
Output Voltage ($T_J = 25^\circ\text{C}$)	V_O	7.7	8.0	8.3	7.7	8.0	8.3	Vdc
Output Voltage ($5.0\text{ mA} \leq I_O \leq 1.0\text{ A}$, $P_D \leq 15\text{ W}$) $10.5\text{ Vdc} \leq V_{in} \leq 23\text{ Vdc}$ $11.5\text{ Vdc} \leq V_{in} \leq 23\text{ Vdc}$	V_O	– 7.6	– 8.0	– 8.4	7.6 –	8.0 –	8.4 –	Vdc
Line Regulation, $T_J = 25^\circ\text{C}$. (Note 2) $10.5\text{ Vdc} \leq V_{in} \leq 25\text{ Vdc}$ $11\text{ Vdc} \leq V_{in} \leq 17\text{ Vdc}$	Regline	– –	6.0 1.7	160 80	– –	6.0 1.7	160 80	mV
Load Regulation, $T_J = 25^\circ\text{C}$ (Note 2) $5.0\text{ mA} \leq I_O \leq 1.5\text{ A}$ $250\text{ mA} \leq I_O \leq 750\text{ mA}$	Regload	– –	1.4 .22	160 80	– –	1.4 .22	160 80	mV
Quiescent Current ($T_J = 25^\circ\text{C}$)	I_B	–	3.3	8.0	–	3.3	8.0	mA

NOTES: 1. $T_{low} = 0^\circ\text{C}$ for MC78XXAC, C $T_{high} = +125^\circ\text{C}$ for MC78XXAC, C, B
= -40°C for MC78XXB

2. Load and line regulation are specified at constant junction temperature. Changes in V_O due to heating effects must be taken into account separately. Pulse testing with low duty cycle is used.

MC7800 Series

ELECTRICAL CHARACTERISTICS (continued) ($V_{in} = 14\text{ V}$, $I_O = 500\text{ mA}$, $T_J = T_{low}$ to T_{high} [Note 1], unless otherwise noted.)

Characteristic	Symbol	MC7808B			MC7808C			Unit
		Min	Typ	Max	Min	Typ	Max	
Quiescent Current Change 10.5 Vdc $\leq V_{in} \leq 25\text{ Vdc}$ 11.5 Vdc $\leq V_{in} \leq 25\text{ Vdc}$ 5.0 mA $\leq I_O \leq 1.0\text{ A}$	ΔI_B	-	-	-	-	-	1.0	mA
		-	-	1.0	-	-	-	
		-	-	0.5	-	-	0.5	
Ripple Rejection 11.5 Vdc $\leq V_{in} \leq 18\text{ Vdc}$, $f = 120\text{ Hz}$	RR	-	62	-	-	62	-	dB
Dropout Voltage ($I_O = 1.0\text{ A}$, $T_J = 25^\circ\text{C}$)	$V_I - V_O$	-	2.0	-	-	2.0	-	Vdc
Output Noise Voltage ($T_A = 25^\circ\text{C}$) 10 Hz $\leq f \leq 100\text{ kHz}$	V_n	-	10	-	-	10	-	$\mu\text{V}/V_O$
Output Resistance $f = 1.0\text{ kHz}$	r_O	-	0.9	-	-	0.9	-	m Ω
Short Circuit Current Limit ($T_A = 25^\circ\text{C}$) $V_{in} = 35\text{ Vdc}$	I_{SC}	-	0.2	-	-	0.2	-	A
Peak Output Current ($T_J = 25^\circ\text{C}$)	I_{max}	-	2.2	-	-	2.2	-	A
Average Temperature Coefficient of Output Voltage	TCV_O	-	-0.4	-	-	-0.4	-	mV/ $^\circ\text{C}$

3

ELECTRICAL CHARACTERISTICS ($V_{in} = 14\text{ V}$, $I_O = 1.0\text{ A}$, $T_J = T_{low}$ to T_{high} [Note 1], unless otherwise noted.)

Characteristic	Symbol	MC7808AC			Unit
		Min	Typ	Max	
Output Voltage ($T_J = 25^\circ\text{C}$)	V_O	7.84	8.0	8.16	Vdc
Output Voltage (5.0 mA $\leq I_O \leq 1.0\text{ A}$, $P_D \leq 15\text{ W}$) 10.6 Vdc $\leq V_{in} \leq 23\text{ Vdc}$	V_O	7.7	8.0	8.3	Vdc
Line Regulation (Note 2) 10.6 Vdc $\leq V_{in} \leq 25\text{ Vdc}$, $I_O = 500\text{ mA}$ 11 Vdc $\leq V_{in} \leq 17\text{ Vdc}$ 11 Vdc $\leq V_{in} \leq 17\text{ Vdc}$, $T_J = 25^\circ\text{C}$ 10.4 Vdc $\leq V_{in} \leq 23\text{ Vdc}$, $T_J = 25^\circ\text{C}$	Reg _{line}	-	6.0	80	mV
		-	1.7	80	
		-	1.7	40	
		-	5.0	80	
Load Regulation (Note 2) 5.0 mA $\leq I_O \leq 1.5\text{ A}$, $T_J = 25^\circ\text{C}$ 5.0 mA $\leq I_O \leq 1.0\text{ A}$ 250 mA $\leq I_O \leq 750\text{ mA}$	Reg _{load}	-	1.4	100	mV
		-	1.0	100	
		-	.22	50	
Quiescent Current $T_J = 25^\circ\text{C}$	I_B	-	-	6.0	mA
-	-	3.3	6.0		
Quiescent Current Change 11 Vdc $\leq V_{in} \leq 25\text{ Vdc}$, $I_O = 500\text{ mA}$ 10.6 Vdc $\leq V_{in} \leq 20\text{ Vdc}$, $T_J = 25^\circ\text{C}$ 5.0 mA $\leq I_O \leq 1.0\text{ A}$	ΔI_B	-	-	0.8	mA
		-	-	0.8	
		-	-	0.5	
Ripple Rejection 11.5 Vdc $\leq V_{in} \leq 21.5\text{ Vdc}$, $f = 120\text{ Hz}$, $I_O = 500\text{ mA}$	RR	-	62	-	dB
Dropout Voltage ($I_O = 1.0\text{ A}$, $T_J = 25^\circ\text{C}$)	$V_I - V_O$	-	2.0	-	Vdc
Output Noise Voltage ($T_A = 25^\circ\text{C}$) 10 Hz $\leq f \leq 100\text{ kHz}$	V_n	-	10	-	$\mu\text{V}/V_O$
Output Resistance $f = 1.0\text{ kHz}$	r_O	-	0.9	-	m Ω
Short Circuit Current Limit ($T_A = 25^\circ\text{C}$) $V_{in} = 35\text{ Vdc}$	I_{SC}	-	0.2	-	A
Peak Output Current ($T_J = 25^\circ\text{C}$)	I_{max}	-	2.2	-	A
Average Temperature Coefficient of Output Voltage	TCV_O	-	-0.4	-	mV/ $^\circ\text{C}$

NOTES: 1. $T_{low} = 0^\circ\text{C}$ for MC78XXAC, C $T_{high} = +125^\circ\text{C}$ for MC78XXAC, C, B
= -40°C for MC78XXB

2. Load and line regulation are specified at constant junction temperature. Changes in V_O due to heating effects must be taken into account separately. Pulse testing with low duty cycle is used.

MC7800 Series

ELECTRICAL CHARACTERISTICS ($V_{in} = 15\text{ V}$, $I_O = 500\text{ mA}$, $T_J = T_{low}$ to T_{high} [Note 1], unless otherwise noted.)

Characteristic	Symbol	MC7809CT			Unit
		Min	Typ	Max	
Output Voltage ($T_J = 25^\circ\text{C}$)	V_O	8.65	9.0	9.35	Vdc
Output Voltage ($5.0\text{ mA} \leq I_O \leq 1.0\text{ A}$, $P_D \leq 15\text{ W}$) $11.5\text{ Vdc} \leq V_{in} \leq 24\text{ Vdc}$	V_O	8.55	9.0	9.45	Vdc
Line Regulation, $T_J = 25^\circ\text{C}$ (Note 2) $11.5\text{ Vdc} \leq V_{in} \leq 26\text{ Vdc}$ $11.5\text{ Vdc} \leq V_{in} \leq 17\text{ Vdc}$	Regline	–	6.2 1.8	50 25	mV
Load Regulation, $T_J = 25^\circ\text{C}$ (Note 2) $5.0\text{ mA} \leq I_O \leq 1.5\text{ A}$ $250\text{ mA} \leq I_O \leq 750\text{ mA}$	Regload	–	1.5 0.3	50 25	mV
Quiescent Current ($T_J = 25^\circ\text{C}$)	I_B	–	3.4	8.0	mA
Quiescent Current Change $11.5\text{ Vdc} \leq V_{in} \leq 26\text{ Vdc}$ $5.0\text{ mA} \leq I_O \leq 1.0\text{ A}$	ΔI_B	–	–	1.0 0.5	mA
Ripple Rejection $11.5\text{ Vdc} \leq V_{in} \leq 21.5\text{ Vdc}$, $f = 120\text{ Hz}$	RR	–	61	–	dB
Dropout Voltage ($I_O = 1.0\text{ A}$, $T_J = 25^\circ\text{C}$)	$V_I - V_O$	–	2.0	–	Vdc
Output Noise Voltage ($T_A = 25^\circ\text{C}$) $10\text{ Hz} \leq f \leq 100\text{ kHz}$	V_n	–	10	–	$\mu\text{V}/V_O$
Output Resistance $f = 1.0\text{ kHz}$	r_O	–	1.0	–	$\text{m}\Omega$
Short Circuit Current Limit ($T_A = 25^\circ\text{C}$) $V_{in} = 35\text{ Vdc}$	I_{SC}	–	0.2	–	A
Peak Output Current ($T_J = 25^\circ\text{C}$)	I_{max}	–	2.2	–	A
Average Temperature Coefficient of Output Voltage	TCV_O	–	–0.5	–	$\text{mV}/^\circ\text{C}$

ELECTRICAL CHARACTERISTICS ($V_{in} = 19\text{ V}$, $I_O = 500\text{ mA}$, $T_J = T_{low}$ to T_{high} [Note 1], unless otherwise noted.)

Characteristic	Symbol	MC7812B			MC7812C			Unit
		Min	Typ	Max	Min	Typ	Max	
Output Voltage ($T_J = 25^\circ\text{C}$)	V_O	11.5	12	12.5	11.5	12	12.5	Vdc
Output Voltage ($5.0\text{ mA} \leq I_O \leq 1.0\text{ A}$, $P_D \leq 15\text{ W}$) $14.5\text{ Vdc} \leq V_{in} \leq 27\text{ Vdc}$ $15.5\text{ Vdc} \leq V_{in} \leq 27\text{ Vdc}$	V_O	– 11.4	– 12	– 12.6	11.4 –	12 –	12.6 –	Vdc
Line Regulation, $T_J = 25^\circ\text{C}$ (Note 2) $14.5\text{ Vdc} \leq V_{in} \leq 30\text{ Vdc}$ $16\text{ Vdc} \leq V_{in} \leq 22\text{ Vdc}$	Regline	–	7.5 2.2	240 120	–	7.5 2.2	240 120	mV
Load Regulation, $T_J = 25^\circ\text{C}$ (Note 2) $5.0\text{ mA} \leq I_O \leq 1.5\text{ A}$ $250\text{ mA} \leq I_O \leq 750\text{ mA}$	Regload	–	1.6 1.0	240 120	–	1.6 1.0	240 120	mV
Quiescent Current ($T_J = 25^\circ\text{C}$)	I_B	–	3.4	8.0	–	3.4	8.0	mA
Quiescent Current Change $14.5\text{ Vdc} \leq V_{in} \leq 30\text{ Vdc}$ $15\text{ Vdc} \leq V_{in} \leq 30\text{ Vdc}$ $5.0\text{ mA} \leq I_O \leq 1.0\text{ A}$	ΔI_B	–	–	–	–	–	1.0 – 0.5	mA
Ripple Rejection $15\text{ Vdc} \leq V_{in} \leq 25\text{ Vdc}$, $f = 120\text{ Hz}$	RR	–	60	–	–	60	–	dB
Dropout Voltage ($I_O = 1.0\text{ A}$, $T_J = 25^\circ\text{C}$)	$V_I - V_O$	–	2.0	–	–	2.0	–	Vdc

NOTES: 1. $T_{low} = 0^\circ\text{C}$ for MC78XXAC, C $T_{high} = +125^\circ\text{C}$ for MC78XXAC, C, B
= -40°C for MC78XXB

2. Load and line regulation are specified at constant junction temperature. Changes in V_O due to heating effects must be taken into account separately. Pulse testing with low duty cycle is used.

MC7800 Series

ELECTRICAL CHARACTERISTICS (continued) ($V_{in} = 19\text{ V}$, $I_O = 500\text{ mA}$, $T_J = T_{low}$ to T_{high} [Note 1], unless otherwise noted.)

Characteristic	Symbol	MC7812B			MC7812C			Unit
		Min	Typ	Max	Min	Typ	Max	
Output Noise Voltage ($T_A = 25^\circ\text{C}$) $10\text{ Hz} \leq f \leq 100\text{ kHz}$	V_n	–	10	–	–	10	–	$\mu\text{V}/V_O$
Output Resistance ($f = 1.0\text{ kHz}$)	r_O	–	1.1	–	–	1.1	–	$\text{m}\Omega$
Short Circuit Current Limit ($T_A = 25^\circ\text{C}$) $V_{in} = 35\text{ Vdc}$	I_{SC}	–	0.2	–	–	0.2	–	A
Peak Output Current ($T_J = 25^\circ\text{C}$)	I_{max}	–	2.2	–	–	2.2	–	A
Average Temperature Coefficient of Output Voltage	TCV_O	–	–0.8	–	–	–0.8	–	$\text{mV}/^\circ\text{C}$

3

ELECTRICAL CHARACTERISTICS ($V_{in} = 19\text{ V}$, $I_O = 10\text{ A}$, $T_J = T_{low}$ to T_{high} [Note 1], unless otherwise noted.)

Characteristic	Symbol	MC7812AC			Unit
		Min	Typ	Max	
Output Voltage ($T_J = 25^\circ\text{C}$)	V_O	11.75	12	12.25	Vdc
Output Voltage ($5.0\text{ mA} \leq I_O \leq 1.0\text{ A}$, $P_D \leq 15\text{ W}$) $14.8\text{ Vdc} \leq V_{in} \leq 27\text{ Vdc}$	V_O	11.5	12	12.5	Vdc
Line Regulation (Note 2) $14.8\text{ Vdc} \leq V_{in} \leq 30\text{ Vdc}$, $I_O = 500\text{ mA}$ $16\text{ Vdc} \leq V_{in} \leq 22\text{ Vdc}$ $16\text{ Vdc} \leq V_{in} \leq 22\text{ Vdc}$, $T_J = 25^\circ\text{C}$ $14.5\text{ Vdc} \leq V_{in} \leq 27\text{ Vdc}$, $T_J = 25^\circ\text{C}$	Regline	–	7.5 2.2 2.2 6.0	120 120 60 120	mV
Load Regulation (Note 2) $5.0\text{ mA} \leq I_O \leq 1.5\text{ A}$, $T_J = 25^\circ\text{C}$ $5.0\text{ mA} \leq I_O \leq 1.0\text{ A}$ $250\text{ mA} \leq I_O \leq 750\text{ mA}$	Regload	–	1.6 1.2 1.0	100 100 50	mV
Quiescent Current $T_J = 25^\circ\text{C}$	I_B	–	– 3.4	6.0 6.0	mA
Quiescent Current Change $15\text{ Vdc} \leq V_{in} \leq 30\text{ Vdc}$, $I_O = 500\text{ mA}$ $14.8\text{ Vdc} \leq V_{in} \leq 27\text{ Vdc}$, $T_J = 25^\circ\text{C}$ $5.0\text{ mA} \leq I_O \leq 1.0\text{ A}$	ΔI_B	–	–	0.8 0.8 0.5	mA
Ripple Rejection $15\text{ Vdc} \leq V_{in} \leq 25\text{ Vdc}$, $f = 120\text{ Hz}$, $I_O = 500\text{ mA}$	RR	–	60	–	dB
Dropout Voltage ($I_O = 1.0\text{ A}$, $T_J = 25^\circ\text{C}$)	$V_I - V_O$	–	2.0	–	Vdc
Output Noise Voltage ($T_A = 25^\circ\text{C}$) $10\text{ Hz} \leq f \leq 100\text{ kHz}$	V_n	–	10	–	$\mu\text{V}/V_O$
Output Resistance ($f = 1.0\text{ kHz}$)	r_O	–	1.1	–	$\text{m}\Omega$
Short Circuit Current Limit ($T_A = 25^\circ\text{C}$) $V_{in} = 35\text{ Vdc}$	I_{SC}	–	0.2	–	A
Peak Output Current ($T_J = 25^\circ\text{C}$)	I_{max}	–	2.2	–	A
Average Temperature Coefficient of Output Voltage	TCV_O	–	–0.8	–	$\text{mV}/^\circ\text{C}$

NOTES: 1. $T_{low} = 0^\circ\text{C}$ for MC78XXAC, $T_{high} = +125^\circ\text{C}$ for MC78XXAC, $T_{high} = -40^\circ\text{C}$ for MC78XXB

2. Load and line regulation are specified at constant junction temperature. Changes in V_O due to heating effects must be taken into account separately. Pulse testing with low duty cycle is used.

MC7800 Series

ELECTRICAL CHARACTERISTICS ($V_{in} = 23\text{ V}$, $I_O = 500\text{ mA}$, $T_J = T_{low}$ to T_{high} [Note 1], unless otherwise noted.)

Characteristic	Symbol	MC7815B			MC7815C			Unit
		Min	Typ	Max	Min	Typ	Max	
Output Voltage ($T_J = 25^\circ\text{C}$)	V_O	14.4	15	15.6	14.4	15	15.6	Vdc
Output Voltage ($5.0\text{ mA} \leq I_O \leq 1.0\text{ A}$, $P_D \leq 15\text{ W}$) $17.5\text{ Vdc} \leq V_{in} \leq 30\text{ Vdc}$ $18.5\text{ Vdc} \leq V_{in} \leq 30\text{ Vdc}$	V_O	– 14.25	– 15	– 15.75	14.25 –	15 –	15.75 –	Vdc
Line Regulation, $T_J = 25^\circ\text{C}$ (Note 2) $17.5\text{ Vdc} \leq V_{in} \leq 30\text{ Vdc}$ $20\text{ Vdc} \leq V_{in} \leq 26\text{ Vdc}$	Regline	– –	8.5 3.0	300 150	– –	8.5 3.0	300 150	mV
Load Regulation, $T_J = 25^\circ\text{C}$ (Note 2) $5.0\text{ mA} \leq I_O \leq 1.5\text{ A}$ $250\text{ mA} \leq I_O \leq 750\text{ mA}$	Regload	– –	1.8 1.2	300 150	– –	1.8 1.2	300 150	mV
Quiescent Current ($T_J = 25^\circ\text{C}$)	I_B	–	3.5	8.0	–	3.5	8.0	mA
Quiescent Current Change $17.5\text{ Vdc} \leq V_{in} \leq 30\text{ Vdc}$ $18.5\text{ Vdc} \leq V_{in} \leq 30\text{ Vdc}$ $5.0\text{ mA} \leq I_O \leq 1.0\text{ A}$	ΔI_B	– – –	– – –	– 1.0 0.5	– – –	– – –	1.0 – 0.5	mA
Ripple Rejection $18.5\text{ Vdc} \leq V_{in} \leq 28.5\text{ Vdc}$, $f = 120\text{ Hz}$	RR	–	58	–	–	58	–	dB
Dropout Voltage ($I_O = 1.0\text{ A}$, $T_J = 25^\circ\text{C}$)	$V_I - V_O$	–	2.0	–	–	2.0	–	Vdc
Output Noise Voltage ($T_A = 25^\circ\text{C}$) $10\text{ Hz} \leq f \leq 100\text{ kHz}$	V_n	–	10	–	–	10	–	$\mu\text{V}/V_O$
Output Resistance $f = 1.0\text{ kHz}$	r_O	–	1.2	–	–	1.2	–	$\text{m}\Omega$
Short Circuit Current Limit ($T_A = 25^\circ\text{C}$) $V_{in} = 35\text{ Vdc}$	I_{SC}	–	0.2	–	–	0.2	–	A
Peak Output Current ($T_J = 25^\circ\text{C}$)	I_{max}	–	2.2	–	–	2.2	–	A
Average Temperature Coefficient of Output Voltage	TCV_O	–	–1.0	–	–	–1.0	–	$\text{mV}/^\circ\text{C}$

ELECTRICAL CHARACTERISTICS ($V_{in} = 23\text{ V}$, $I_O = 1.0\text{ A}$, $T_J = T_{low}$ to T_{high} [Note 1], unless otherwise noted.)

Characteristic	Symbol	MC7815AC			Unit
		Min	Typ	Max	
Output Voltage ($T_J = 25^\circ\text{C}$)	V_O	14.7	15	15.3	Vdc
Output Voltage ($5.0\text{ mA} \leq I_O \leq 1.0\text{ A}$, $P_D \leq 15\text{ W}$) $17.9\text{ Vdc} \leq V_{in} \leq 30\text{ Vdc}$	V_O	14.4	15	15.6	Vdc
Line Regulation (Note 2) $17.9\text{ Vdc} \leq V_{in} \leq 30\text{ Vdc}$, $I_O = 500\text{ mA}$ $20\text{ Vdc} \leq V_{in} \leq 26\text{ Vdc}$ $20\text{ Vdc} \leq V_{in} \leq 26\text{ Vdc}$, $T_J = 25^\circ\text{C}$ $17.5\text{ Vdc} \leq V_{in} \leq 30\text{ Vdc}$, $T_J = 25^\circ\text{C}$	Regline	– – – –	8.5 3.0 3.0 7.0	150 150 75 150	mV
Load Regulation (Note 2) $5.0\text{ mA} \leq I_O \leq 1.5\text{ A}$, $T_J = 25^\circ\text{C}$ $5.0\text{ mA} \leq I_O \leq 1.0\text{ A}$ $250\text{ mA} \leq I_O \leq 750\text{ mA}$	Regload	– – –	1.8 1.5 1.2	100 100 50	mV
Quiescent Current $T_J = 25^\circ\text{C}$	I_B	– –	– 3.5	6.0 6.0	mA
Quiescent Current Change $17.5\text{ Vdc} \leq V_{in} \leq 30\text{ Vdc}$, $I_O = 500\text{ mA}$ $17.5\text{ Vdc} \leq V_{in} \leq 30\text{ Vdc}$, $T_J = 25^\circ\text{C}$ $5.0\text{ mA} \leq I_O \leq 1.0\text{ A}$	ΔI_B	– – –	– – –	0.8 0.8 0.5	mA

NOTES: 1. $T_{low} = 0^\circ\text{C}$ for MC78XXAC, C $T_{high} = +125^\circ\text{C}$ for MC78XXAC, C, B
= -40°C for MC78XXB

2. Load and line regulation are specified at constant junction temperature. Changes in V_O due to heating effects must be taken into account separately. Pulse testing with low duty cycle is used.

MC7800 Series

ELECTRICAL CHARACTERISTICS (continued) ($V_{in} = 23\text{ V}$, $I_O = 1.0\text{ A}$, $T_J = T_{low}$ to T_{high} [Note 1], unless otherwise noted.)

Characteristic	Symbol	MC7815AC			Unit
		Min	Typ	Max	
Ripple Rejection $18.5\text{ Vdc} \leq V_{in} \leq 28.5\text{ Vdc}$, $f = 120\text{ Hz}$, $I_O = 500\text{ mA}$	RR	–	58	–	dB
Dropout Voltage ($I_O = 1.0\text{ A}$, $T_J = 25^\circ\text{C}$)	$V_I - V_O$	–	2.0	–	Vdc
Output Noise Voltage ($T_A = 25^\circ\text{C}$) $10\text{ Hz} \leq f \leq 100\text{ kHz}$	V_n	–	10	–	$\mu\text{V}/V_O$
Output Resistance $f = 1.0\text{ kHz}$	r_O	–	1.2	–	$\text{m}\Omega$
Short Circuit Current Limit ($T_A = 25^\circ\text{C}$) $V_{in} = 35\text{ Vdc}$	I_{SC}	–	0.2	–	A
Peak Output Current ($T_J = 25^\circ\text{C}$)	I_{max}	–	2.2	–	A
Average Temperature Coefficient of Output Voltage	TCV_O	–	–1.0	–	$\text{mV}/^\circ\text{C}$

ELECTRICAL CHARACTERISTICS ($V_{in} = 27\text{ V}$, $I_O = 500\text{ mA}$, $T_J = T_{low}$ to T_{high} [Note 1], unless otherwise noted.)

Characteristic	Symbol	MC7818B			MC7818C			Unit
		Min	Typ	Max	Min	Typ	Max	
Output Voltage ($T_J = 25^\circ\text{C}$)	V_O	17.3	18	18.7	17.3	18	18.7	Vdc
Output Voltage ($5.0\text{ mA} \leq I_O \leq 1.0\text{ A}$, $P_D \leq 15\text{ W}$) $21\text{ Vdc} \leq V_{in} \leq 33\text{ Vdc}$ $22\text{ Vdc} \leq V_{in} \leq 33\text{ Vdc}$	V_O	– 17.1	– 18	– 18.9	17.1 –	18 –	18.9 –	Vdc
Line Regulation, $T_J = 25^\circ\text{C}$ (Note 2) $21\text{ Vdc} \leq V_{in} \leq 33\text{ Vdc}$ $24\text{ Vdc} \leq V_{in} \leq 30\text{ Vdc}$	Reg_{line}	– –	9.5 3.2	360 180	– –	9.5 3.2	360 180	mV
Load Regulation, $T_J = 25^\circ\text{C}$ (Note 2) $5.0\text{ mA} \leq I_O \leq 1.5\text{ A}$ $250\text{ mA} \leq I_O \leq 750\text{ mA}$	Reg_{load}	– –	2.0 1.5	360 180	– –	2.0 1.5	360 180	mV
Quiescent Current ($T_J = 25^\circ\text{C}$)	I_B	–	3.5	8.0	–	3.5	8.0	mA
Quiescent Current Change $21\text{ Vdc} \leq V_{in} \leq 33\text{ Vdc}$ $22\text{ Vdc} \leq V_{in} \leq 33\text{ Vdc}$ $5.0\text{ mA} \leq I_O \leq 1.0\text{ A}$	ΔI_B	– – –	– – –	– 1.0 0.5	– – –	– – –	1.0 – 0.5	mA
Ripple Rejection $22\text{ Vdc} \leq V_{in} \leq 33\text{ Vdc}$, $f = 120\text{ Hz}$	RR	–	57	–	–	57	–	dB
Dropout Voltage ($I_O = 1.0\text{ A}$, $T_J = 25^\circ\text{C}$)	$V_{I1} - V_O$	–	2.0	–	–	2.0	–	Vdc
Output Noise Voltage ($T_A = 25^\circ\text{C}$) $10\text{ Hz} \leq f \leq 100\text{ kHz}$	V_n	–	10	–	–	10	–	$\mu\text{V}/V_O$
Output Resistance $f = 1.0\text{ kHz}$	r_O	–	1.3	–	–	1.3	–	$\text{m}\Omega$
Short Circuit Current Limit ($T_A = 25^\circ\text{C}$) $V_{in} = 35\text{ Vdc}$	I_{SC}	–	0.2	–	–	0.2	–	A
Peak Output Current ($T_J = 25^\circ\text{C}$)	I_{max}	–	2.2	–	–	2.2	–	A
Average Temperature Coefficient of Output Voltage	TCV_O	–	–1.5	–	–	–1.5	–	$\text{mV}/^\circ\text{C}$

NOTES: 1. $T_{low} = 0^\circ\text{C}$ for MC78XXAC, C $T_{high} = +125^\circ\text{C}$ for MC78XXAC, C, B
= -40°C for MC78XXB

2. Load and line regulation are specified at constant junction temperature. Changes in V_O due to heating effects must be taken into account separately. Pulse testing with low duty cycle is used

MC7800 Series

ELECTRICAL CHARACTERISTICS ($V_{in} = 27\text{ V}$, $I_O = 10\text{ A}$, $T_J = T_{low}$ to T_{high} [Note 1], unless otherwise noted.)

Characteristic	Symbol	MC7818AC			Unit
		Min	Typ	Max	
Output Voltage ($T_J = 25^\circ\text{C}$)	V_O	17.64	18	18.36	Vdc
Output Voltage ($5.0\text{ mA} \leq I_O \leq 1.0\text{ A}$, $P_D \leq 15\text{ W}$) $21\text{ Vdc} \leq V_{in} \leq 33\text{ Vdc}$	V_O	17.3	18	18.7	Vdc
Line Regulation (Note 2) $21\text{ Vdc} \leq V_{in} \leq 33\text{ Vdc}$, $I_O = 500\text{ mA}$ $24\text{ Vdc} \leq V_{in} \leq 30\text{ Vdc}$ $24\text{ Vdc} \leq V_{in} \leq 30\text{ Vdc}$, $T_J = 25^\circ\text{C}$ $20.6\text{ Vdc} \leq V_{in} \leq 33\text{ Vdc}$, $T_J = 25^\circ\text{C}$	Regline	–	9.5	180	mV
Load Regulation (Note 2) $5.0\text{ mA} \leq I_O \leq 1.5\text{ A}$, $T_J = 25^\circ\text{C}$ $5.0\text{ mA} \leq I_O \leq 1.0\text{ A}$ $250\text{ mA} \leq I_O \leq 750\text{ mA}$	Regload	–	2.0	100	mV
Quiescent Current $T_J = 25^\circ\text{C}$	I_B	–	–	6.0	mA
Quiescent Current Change $21\text{ Vdc} \leq V_{in} \leq 33\text{ Vdc}$, $I_O = 500\text{ mA}$ $21\text{ Vdc} \leq V_{in} \leq 33\text{ Vdc}$, $T_J = 25^\circ\text{C}$ $5.0\text{ mA} \leq I_O \leq 1.0\text{ A}$	ΔI_B	–	–	0.8	mA
Ripple Rejection $22\text{ Vdc} \leq V_{in} \leq 32\text{ Vdc}$, $f = 120\text{ Hz}$, $I_O = 500\text{ mA}$	RR	–	57	–	dB
Dropout Voltage ($I_O = 1.0\text{ A}$, $T_J = 25^\circ\text{C}$)	$V_I - V_O$	–	2.0	–	Vdc
Output Noise Voltage ($T_A = 25^\circ\text{C}$) $10\text{ Hz} \leq f \leq 100\text{ kHz}$	V_n	–	10	–	$\mu\text{V}/V_O$
Output Resistance $f = 1.0\text{ kHz}$	r_O	–	1.3	–	$\text{m}\Omega$
Short Circuit Current Limit ($T_A = 25^\circ\text{C}$) $V_{in} = 35\text{ Vdc}$	I_{SC}	–	0.2	–	A
Peak Output Current ($T_J = 25^\circ\text{C}$)	I_{max}	–	2.2	–	A
Average Temperature Coefficient of Output Voltage	TCV_O	–	–1.5	–	$\text{mV}/^\circ\text{C}$

ELECTRICAL CHARACTERISTICS ($V_{in} = 33\text{ V}$, $I_O = 500\text{ mA}$, $T_J = T_{low}$ to T_{high} [Note 1], unless otherwise noted.)

Characteristic	Symbol	MC7824B			MC7824C			Unit
		Min	Typ	Max	Min	Typ	Max	
Output Voltage ($T_J = 25^\circ\text{C}$)	V_O	23	24	25	23	24	25	Vdc
Output Voltage ($5.0\text{ mA} \leq I_O \leq 1.0\text{ A}$, $P_D \leq 15\text{ W}$) $27\text{ Vdc} \leq V_{in} \leq 38\text{ Vdc}$ $28\text{ Vdc} \leq V_{in} \leq 38\text{ Vdc}$	V_O	–	–	–	22.8	24	25.2	Vdc
Line Regulation, $T_J = 25^\circ\text{C}$ (Note 2) $27\text{ Vdc} \leq V_{in} \leq 38\text{ Vdc}$ $30\text{ Vdc} \leq V_{in} \leq 36\text{ Vdc}$	Regline	–	11.5	480	–	11.5	480	mV
Load Regulation, $T_J = 25^\circ\text{C}$ (Note 2) $5.0\text{ mA} \leq I_O \leq 1.5\text{ A}$ $250\text{ mA} \leq I_O \leq 750\text{ mA}$	Regload	–	2.1	480	–	2.1	480	mV
Quiescent Current ($T_J = 25^\circ\text{C}$)	I_B	–	3.6	8.0	–	3.6	8.0	mA

NOTES: 1. $T_{low} = 0^\circ\text{C}$ for MC78XXAC, C $T_{high} = +125^\circ\text{C}$ for MC78XXAC, C, B
= -40°C for MC78XXB

2. Load and line regulation are specified at constant junction temperature. Changes in V_O due to heating effects must be taken into account separately. Pulse testing with low duty cycle is used.

MC7800 Series

ELECTRICAL CHARACTERISTICS (continued) ($V_{in} = 33\text{ V}$, $I_O = 500\text{ mA}$, $T_J = T_{low}$ to T_{high} [Note 1], unless otherwise noted.)

Characteristic	Symbol	MC7824B			MC7824C			Unit
		Min	Typ	Max	Min	Typ	Max	
Quiescent Current Change $27\text{ Vdc} \leq V_{in} \leq 38\text{ Vdc}$ $28\text{ Vdc} \leq V_{in} \leq 38\text{ Vdc}$ $5.0\text{ mA} \leq I_O \leq 1.0\text{ A}$	ΔI_B	-	-	-	-	-	1.0	mA
		-	-	1.0	-	-	-	
		-	-	0.5	-	-	-	
		-	-	-	-	-	-	
Ripple Rejection $28\text{ Vdc} \leq V_{in} \leq 38\text{ Vdc}$, $f = 120\text{ Hz}$	RR	-	54	-	-	54	-	dB
Dropout Voltage ($I_O = 1.0\text{ A}$, $T_J = 25^\circ\text{C}$)	$V_I - V_O$	-	2.0	-	-	2.0	-	Vdc
Output Noise Voltage ($T_A = 25^\circ\text{C}$) $10\text{ Hz} \leq f \leq 100\text{ kHz}$	V_n	-	10	-	-	10	-	$\mu\text{V}/V_O$
Output Resistance $f = 1.0\text{ kHz}$	r_O	-	1.4	-	-	1.4	-	$\text{m}\Omega$
Short Circuit Current Limit ($T_A = 25^\circ\text{C}$) $V_{in} = 35\text{ Vdc}$	I_{SC}	-	0.2	-	-	0.2	-	A
Peak Output Current ($T_J = 25^\circ\text{C}$)	I_{max}	-	2.2	-	-	2.2	-	A
Average Temperature Coefficient of Output Voltage	TCV_O	-	-2.0	-	-	-2.0	-	$\text{mV}/^\circ\text{C}$

3

ELECTRICAL CHARACTERISTICS ($V_{in} = 33\text{ V}$, $I_O = 1.0\text{ A}$, $T_J = T_{low}$ to T_{high} [Note 1], unless otherwise noted.)

Characteristic	Symbol	MC7824AC			Unit
		Min	Typ	Max	
Output Voltage ($T_J = 25^\circ\text{C}$)	V_O	23.5	24	24.5	Vdc
Output Voltage ($5.0\text{ mA} \leq I_O \leq 1.0\text{ A}$, $P_D \leq 15\text{ W}$) $27.3\text{ Vdc} \leq V_{in} \leq 38\text{ Vdc}$	V_O	23	24	25	Vdc
Line Regulation (Note 2) $27\text{ Vdc} \leq V_{in} \leq 38\text{ Vdc}$, $I_O = 500\text{ mA}$ $30\text{ Vdc} \leq V_{in} \leq 36\text{ Vdc}$ $30\text{ Vdc} \leq V_{in} \leq 36\text{ Vdc}$, $T_J = 25^\circ\text{C}$ $26.7\text{ Vdc} \leq V_{in} \leq 38\text{ Vdc}$, $T_J = 25^\circ\text{C}$	Regline	-	11.5	240	mV
		-	3.8	240	
		-	3.8	120	
		-	10	240	
Load Regulation (Note 2) $5.0\text{ mA} \leq I_O \leq 1.5\text{ A}$, $T_J = 25^\circ\text{C}$ $5.0\text{ mA} \leq I_O \leq 1.0\text{ A}$ $250\text{ mA} \leq I_O \leq 750\text{ mA}$	Regload	-	2.1	100	mV
		-	2.0	100	
		-	1.8	50	
Quiescent Current $T_J = 25^\circ\text{C}$	I_B	-	-	6.0	mA
-	-	3.6	6.0		
Quiescent Current Change $27.3\text{ Vdc} \leq V_{in} \leq 38\text{ Vdc}$, $I_O = 500\text{ mA}$ $27.3\text{ Vdc} \leq V_{in} \leq 38\text{ Vdc}$, $T_J = 25^\circ\text{C}$ $5.0\text{ mA} \leq I_O \leq 1.0\text{ A}$	ΔI_B	-	-	0.8	mA
		-	-	0.8	
		-	-	0.5	
Ripple Rejection $28\text{ Vdc} \leq V_{in} \leq 38\text{ Vdc}$, $f = 120\text{ Hz}$, $I_O = 500\text{ mA}$	RR	-	54	-	dB
Dropout Voltage ($I_O = 1.0\text{ A}$, $T_J = 25^\circ\text{C}$)	$V_I - V_O$	-	2.0	-	Vdc
Output Noise Voltage ($T_A = 25^\circ\text{C}$) $10\text{ Hz} \leq f \leq 100\text{ kHz}$	V_n	-	10	-	$\mu\text{V}/V_O$
Output Resistance ($f = 1.0\text{ kHz}$)	r_O	-	1.4	-	$\text{m}\Omega$
Short Circuit Current Limit ($T_A = 25^\circ\text{C}$) $V_{in} = 35\text{ Vdc}$	I_{SC}	-	0.2	-	A
Peak Output Current ($T_J = 25^\circ\text{C}$)	I_{max}	-	2.2	-	A
Average Temperature Coefficient of Output Voltage	TCV_O	-	-2.0	-	$\text{mV}/^\circ\text{C}$

NOTES: 1. $T_{low} = 0^\circ\text{C}$ for MC78XXAC, C $T_{high} = +125^\circ\text{C}$ for MC78XXAC, C, B
 $= -40^\circ\text{C}$ for MC78XXB

2. Load and line regulation are specified at constant junction temperature. Changes in V_O due to heating effects must be taken into account separately. Pulse testing with low duty cycle is used

MC7800 Series

Figure 1. Peak Output Current as a Function of Input/Output Differential Voltage (MC78XXC, AC, B)

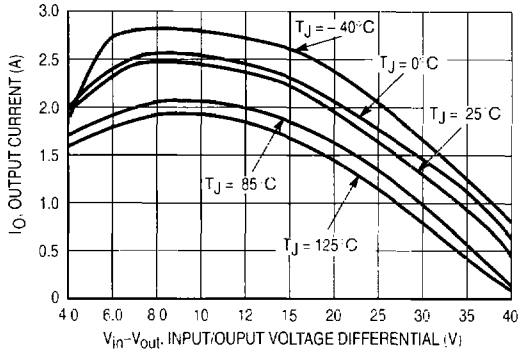

Figure 2. Ripple Rejection as a Function of Output Voltages (MC78XXC, AC)

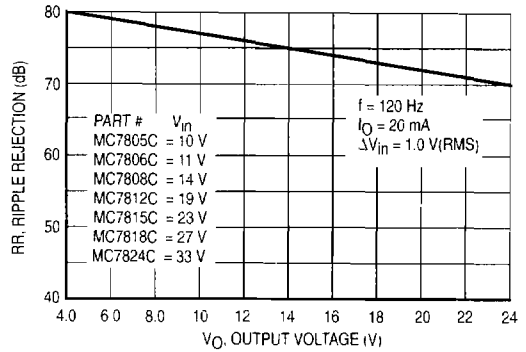

Figure 3. Ripple Rejection as a Function of Frequency (MC78XXC, AC)

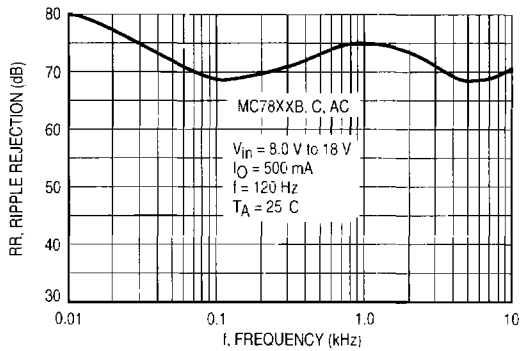

Figure 4. Output Voltage as a Function of Junction Temperature (MC7805C, AC, B)

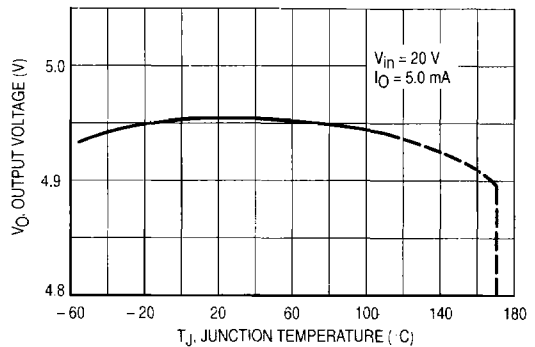

Figure 5. Output Impedance as a Function of Output Voltage (MC78XXC, AC)

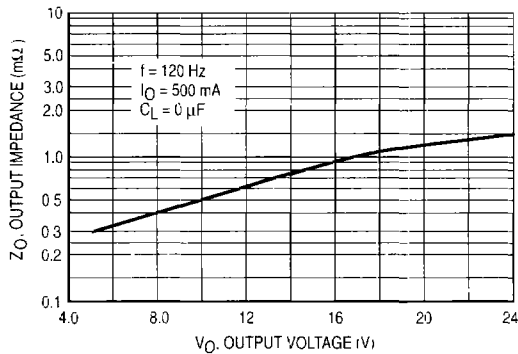
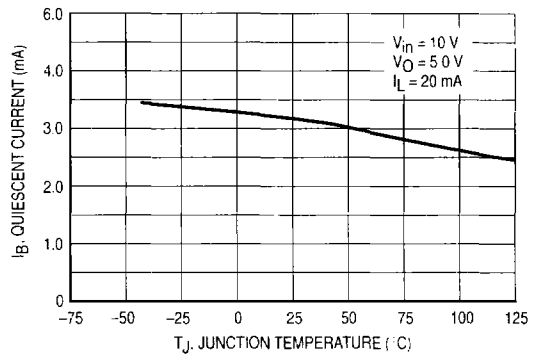

Figure 6. Quiescent Current as a Function of Temperature (MC78XXC, AC, B)



MC7800 Series

APPLICATIONS INFORMATION

Design Considerations

The MC7800 Series of fixed voltage regulators are designed with Thermal Overload Protection that shuts down the circuit when subjected to an excessive power overload condition, Internal Short Circuit Protection that limits the maximum current the circuit will pass, and Output Transistor Safe-Area Compensation that reduces the output short circuit current as the voltage across the pass transistor is increased.

In many low current applications, compensation capacitors are not required. However, it is recommended that the regulator input be bypassed with a capacitor if the regulator is connected to the power supply filter with long

wire lengths, or if the output load capacitance is large. An input bypass capacitor should be selected to provide good high-frequency characteristics to insure stable operation under all load conditions. A 0.33 μF or larger tantalum, mylar, or other capacitor having low internal impedance at high frequencies should be chosen. The bypass capacitor should be mounted with the shortest possible leads directly across the regulators input terminals. Normally good construction techniques should be used to minimize ground loops and lead resistance drops since the regulator has no external sense lead.

3

Figure 7. Current Regulator

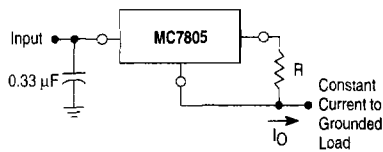

The MC7800 regulators can also be used as a current source when connected as above. In order to minimize dissipation the MC7805C is chosen in this application. Resistor R determines the current as follows:

$$I_O = \frac{5.0 \text{ V}}{R} + I_B$$

$I_B \cong 3.2 \text{ mA}$ over line and load changes.

For example, a 1.0 A current source would require R to be a 5.0 Ω , 10 W resistor and the output voltage compliance would be the input voltage less 7.0 V.

Figure 8. Adjustable Output Regulator

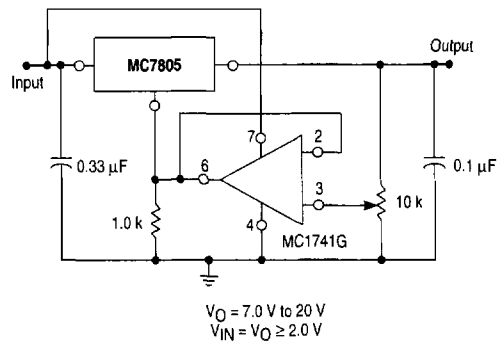

The addition of an operational amplifier allows adjustment to higher or intermediate values while retaining regulation characteristics. The minimum voltage obtainable with this arrangement is 2.0 V greater than the regulator voltage.

Figure 9. Current Boost Regulator

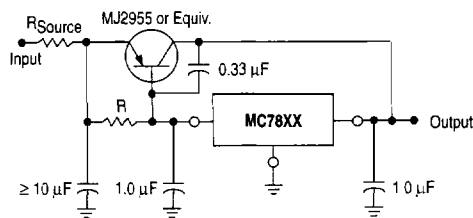

XX = 2 digits of type number indicating voltage

The MC7800 series can be current boosted with a PNP transistor. The MJ2955 provides current to 5.0 A. Resistor R in conjunction with the V_{BE} of the PNP determines when the pass transistor begins conducting; this circuit is not short circuit proof. Input/output differential voltage minimum is increased by V_{BE} of the pass transistor.

Figure 10. Short Circuit Protection

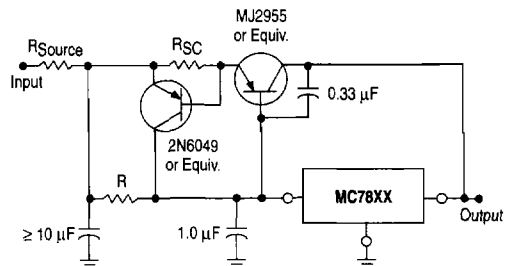

XX = 2 digits of type number indicating voltage.

The circuit of Figure 9 can be modified to provide supply protection against short circuits by adding a short circuit sense resistor, R_{SC} , and an additional PNP transistor. The current sensing PNP must be able to handle the short circuit current of the three-terminal regulator. Therefore, a four-ampere plastic power transistor is specified.

MC7800 Series

Figure 11. Worst Case Power Dissipation versus Ambient Temperature (Case 221A)

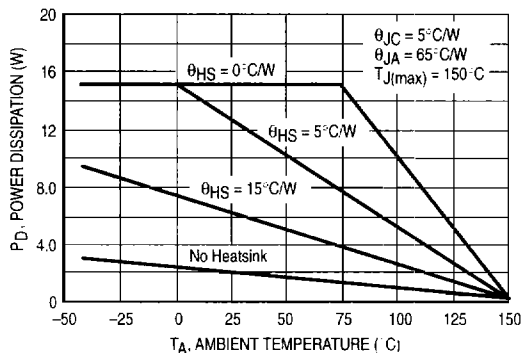

Figure 12. Input Output Differential as a Function of Junction Temperature (MC78XXC, AC, B)

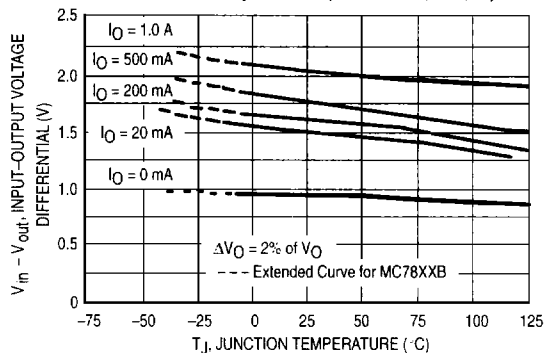
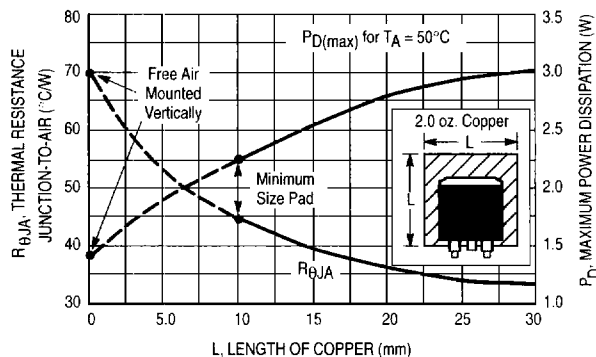

Figure 13. D²PAK Thermal Resistance and Maximum Power Dissipation versus P.C.B. Copper Length



DEFINITIONS

Line Regulation – The change in output voltage for a change in the input voltage. The measurement is made under conditions of low dissipation or by using pulse techniques such that the average chip temperature is not significantly affected.

Load Regulation – The change in output voltage for a change in load current at constant chip temperature.

Maximum Power Dissipation – The maximum total device dissipation for which the regulator will operate within specifications.

Quiescent Current – That part of the input current that is not delivered to the load.

Output Noise Voltage – The rms AC voltage at the output, with constant load and no input ripple, measured over a specified frequency range.

Long Term Stability – Output voltage stability under accelerated life test conditions with the maximum rated voltage listed in the devices' electrical characteristics and maximum power dissipation.