



The Future of Analog IC Technology®

# MP62340/MP62341

## 3.3V/5V, Dual-Channel 1A

### Current-Limited Power Distribution Switches

### DESCRIPTION

The MP62340/MP62341 Power Distribution Switch features internal current limiting to prevent damage to host devices due to faulty load conditions. The MP62340/MP62341 analog switch has 80mΩ on-resistance and operates from 2.7V to 5.5V input. It is available with guaranteed current limits, making it ideal for load switching applications. The MP62340/MP62341 has built-in protection for both over current and increased thermal stress. For over current, the device will limit the current by changing to a constant current mode.

As the temperature increases as a result of short circuit, then the device will shut off. The device will recover once the device temperature reduces to approx 120°C.

The MP62340/MP62341 is available in 8-pin MSOP package with exposed pad and SOIC package without exposed pad.

### FEATURES

- 1A Continuous Current
- Accurate Current Limit
- 2.7V to 5.5V Supply Range
- 140 μA Quiescent Current
- 80mΩ MOSFET
- Thermal-Shutdown Protection
- Under-Voltage Lockout
- 8ms FLAG Deglitch Time
- No FLAG Glitch During Power Up
- Reverse Current Blocking
- Active High & Active Low Options
- Available in MSOP8E and SOIC8
- UL Approved—E322138

### APPLICATIONS

- PDAs
- Portable GPS
- Notebook PC
- Set-top-box
- Telecom and Network Systems
- PC Card Hot Swap
- USB Power Distribution

All MPS parts are lead-free and adhere to the RoHS directive. For MPS green status, please visit MPS website under Quality Assurance. "MPS" and "The Future of Analog IC Technology" are Trademarks of Monolithic Power Systems, Inc.

### TYPICAL APPLICATION

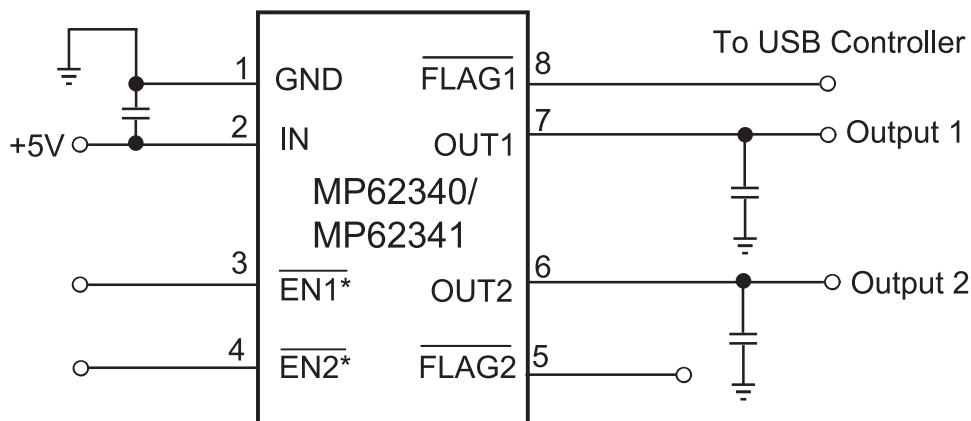

\* EN is active high for MP62341

### ORDERING INFORMATION

Part Number	Enable	Switch	Maximum Continuous Load Current	Typical Short-Circuit Current @ T <sub>A</sub> =25°C	Package	Top Marking	Free Air Temperature Range (T <sub>A</sub> )
MP62340DS	Active Low	Dual	1A	1.5A	SOIC8	62340DS	–40°C to +85°C
MP62341DS	Active High				SOIC8	62341DS	
MP62341DH					MSOP8E	62341DH	

\* For Tape & Reel, add suffix –Z (e.g. MP62340DS -LF-Z).  
 For RoHS compliant packaging, add suffix –LF (e.g. MP62340DS -LF-Z)

### PACKAGE REFERENCE

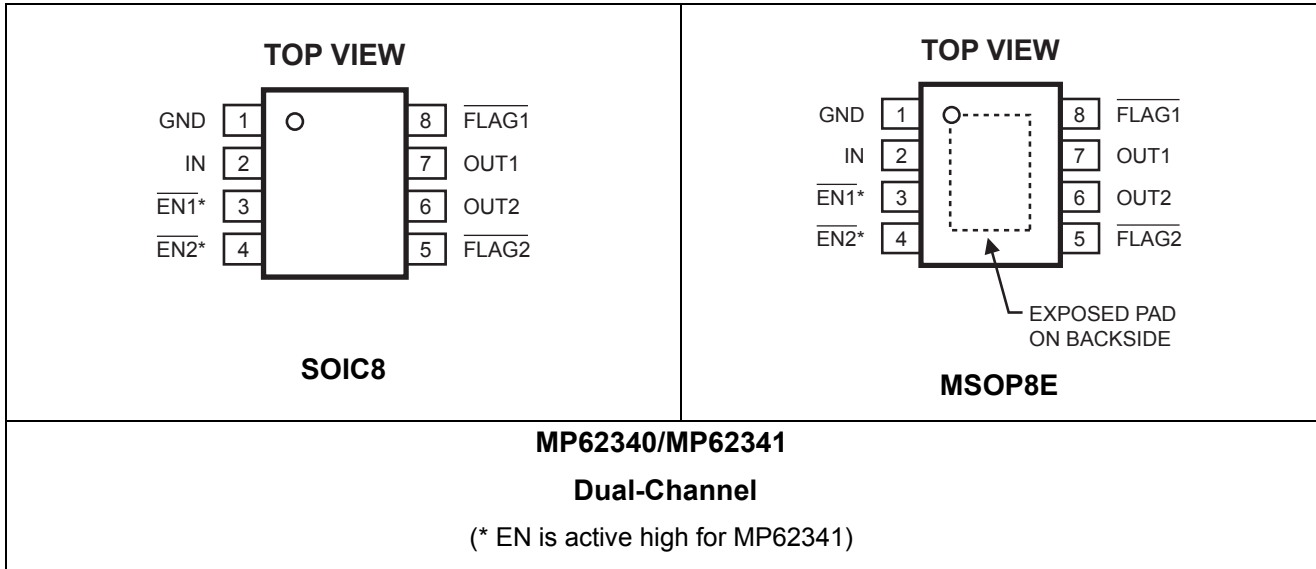

#### ABSOLUTE MAXIMUM RATINGS (1)

IN .....	–0.3V to +6.0V
EN, FLAG, OUT to GND .....	–0.3V to +6.0V
Continuous Power Dissipation (T <sub>A</sub> = +25°C) (2)	
MSOP8E .....	2.3W
SOIC8 .....	1.4W
Junction Temperature .....	150°C
Lead Temperature .....	260°C
Storage Temperature .....	–65°C to +150°C
Operating Junction Temp (T <sub>J</sub> ) ...	–40°C to +125°C

Thermal Resistance (3)	θ <sub>JA</sub>	θ <sub>JC</sub>
SOIC8 .....	90	42
MSOP8E .....	55	12

#### Notes:

- Exceeding these ratings may damage the device.
- The maximum allowable power dissipation is a function of the maximum junction temperature T<sub>J</sub> (MAX), the junction-to-ambient thermal resistance θ<sub>JA</sub>, and the ambient temperature T<sub>A</sub>. The maximum allowable continuous power dissipation at any ambient temperature is calculated by PD (MAX) = (T<sub>J</sub> (MAX) - T<sub>A</sub>)/θ<sub>JA</sub>. Exceeding the maximum allowable power dissipation will cause excessive die temperature, and the regulator will go into thermal shutdown. Internal thermal shutdown circuitry protects the device from permanent damage.
- Measured on JESD51-7, 4-layer PCB.

**ELECTRICAL CHARACTERISTICS (4)**
 **$V_{IN}=5V$ ,  $T_A=+25^{\circ}C$ , unless otherwise noted.**

Parameter	Condition	Min	Typ	Max	Units
IN Voltage Range		2.7		5.5	V
Supply Current	One Channel Enabled, $I_{OUT}=0$ , One Switch ON		90	120	$\mu A$
Supply Current	Both Channels Enabled, $I_{OUT}=0$ , Both Switches ON		140	160	$\mu A$
Shutdown Current	Device Disable, $V_{OUT}=\text{float}$ , $V_{IN}=5.5V$		1		$\mu A$
Off Switch Leakage	Device Disable, $V_{IN}=5.5V$		1		$\mu A$
Current Limit		1.1	1.5	2.2	A
Trip Current	Current Ramp (slew rate $\leq 100A/s$ ) on Output	1.6	1.7	2.4	A
Under-voltage Lockout	Rising Edge	1.95		2.65	V
Under-voltage Hysteresis			250		mV
FET On Resistance	$I_{OUT}=100mA$ ( $-40^{\circ}C \leq T_J \leq 125^{\circ}C$ )		80	130	$m\Omega$
EN Input Logic High Voltage		2			V
EN Input Logic Low Voltage				0.8	V
FLAG Output Logic Low Voltage	$I_{SINK}=5mA$			0.4	V
FLAG Output High Leakage Current	$V_{IN}=V_{FLAG}=5.5V$			1	$\mu A$
Thermal Shutdown			140		$^{\circ}C$
Thermal Shutdown Hysteresis			20		$^{\circ}C$
$V_{OUT}$ Rising Time, $T_r$ (5)	$V_{IN}=5.5V$ , $C_L=1\mu F$ , $R_L=5.5\Omega$		0.9		ms
	$V_{IN}=2.7V$ , $C_L=1\mu F$ , $R_L=5.5\Omega$		1.7		ms
$V_{OUT}$ Falling Time, $T_f$ (6)	$V_{IN}=5.5V$ , $C_L=1\mu F$ , $R_L=5.5\Omega$			0.5	ms
	$V_{IN}=2.7V$ , $C_L=1\mu F$ , $R_L=5.5\Omega$			0.5	ms
Turn On Time, $T_{on}$ (7)	$C_L=100\mu F$ , $R_L=5.5\Omega$			3	ms
Turn Off Time, $T_{off}$ (8)	$C_L=100\mu F$ , $R_L=5.5\Omega$			10	ms
FLAG Deglitch Time		4	8	15	ms
EN Input Leakage			1		$\mu A$
Reverse Leakage Current	$V_{OUT}=5.5V$ , $V_{IN}=\text{GND}$		0.2		$\mu A$

**Notes:**

- 4) Production test at  $+25^{\circ}C$ . Specifications over the temperature range are guaranteed by design and characterization.
- 5) Measured from 10% to 90% output signal.
- 6) Measured from 90% to 10% output signal.
- 7) Measured from 50% EN signal to 90% output signal.
- 8) Measured from 50% EN signal to 10% output signal.

**PIN FUNCTIONS**

SOIC8 MSOP8E	Name	Description
1	GND, Exposed Pad (MSOP8E)	Ground. MSOP8E includes exposed pad. Connect to GND plane for optimal thermal operation.
2	IN	Input Voltage. Accepts 2.7V to 5.5V input.
3	$\overline{\text{EN1}}$	Active Low: (MP62340), Active High: (MP62341)
4	$\overline{\text{EN2}}$	Active Low: (MP62340), Active High: (MP62341)
5	$\overline{\text{FLAG2}}$	IN-to-OUT2 Over-current, active-low output flag. Open-Drain.
6	OUT2	IN-to-OUT2 Power-Distribution Switch Output.
7	OUT1	IN-to-OUT1 Power-Distribution Switch Output
8	$\overline{\text{FLAG1}}$	IN-to-OUT1 Over-current, active-low output flag. Open-Drain.

## TYPICAL PERFORMANCE CHARACTERISTICS

$V_{IN}=5V$ ,  $C_L=1\mu F$ ,  $T_A=25^\circ C$ , for only one channel, unless otherwise noted.

**Turn on Delay vs. Input Voltage**

$R_L=5.5\Omega$ ,  $C_L=100\mu F$

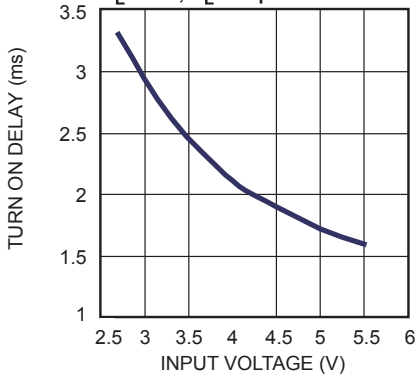

**Turn off Delay vs. Input Voltage**

$R_L=5.5\Omega$ ,  $C_L=100\mu F$

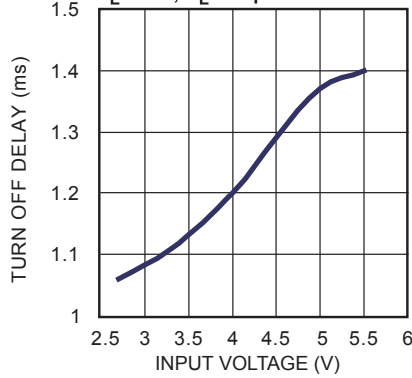

**Rise Time vs. Input Voltage**

$R_L=5.5\Omega$

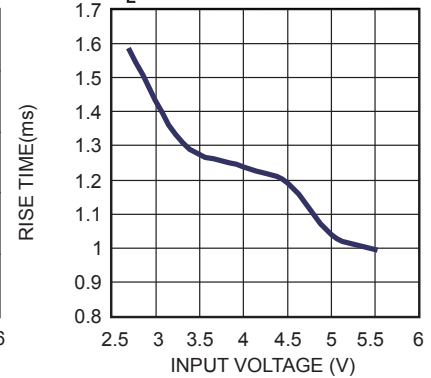

**Fall Time vs. Input Voltage**

$R_L=5.5\Omega$

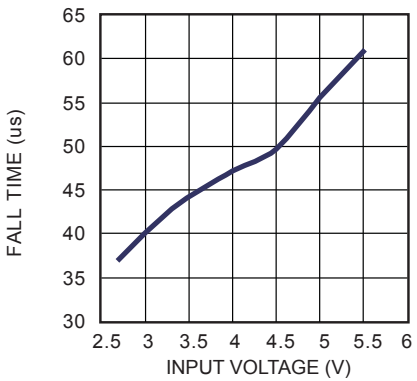

**Supply Current, Output Enable vs. Input Voltage**

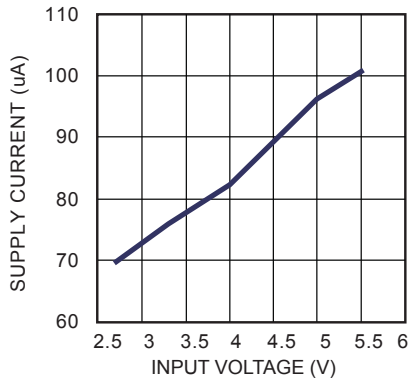

**Static Drain-Source On-State Resistance Variation vs. Ambient Temperature**

$I_O=0.1A$

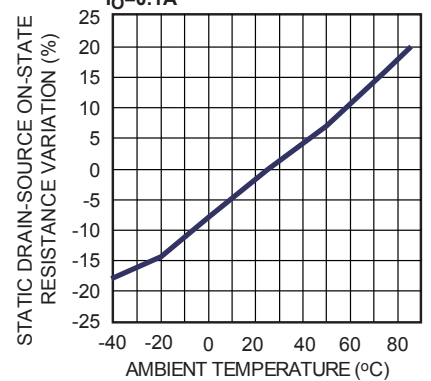

**Static Drain-Source On-State Resistance vs. Input Voltage**

$I_O=1A$

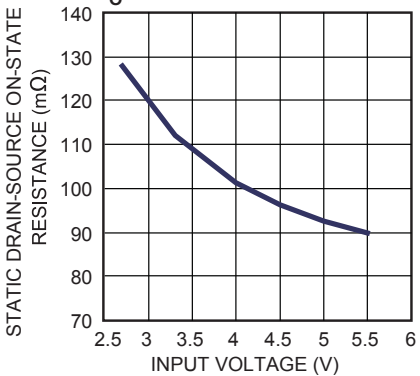

**Input to Output Voltage vs. Load Current**

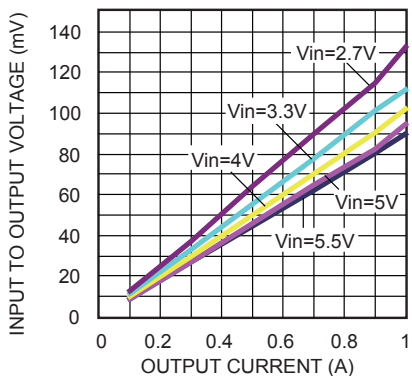

**Current Limit vs. Input Voltage**

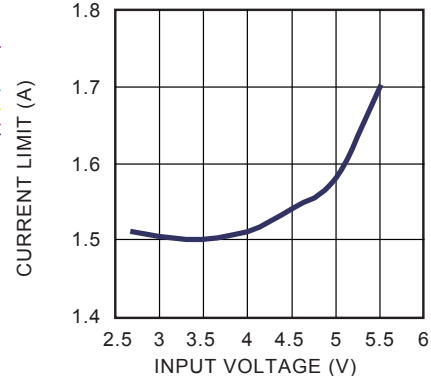

**TYPICAL PERFORMANCE CHARACTERISTICS (continued)**
 $V_{IN}=5V$ ,  $C_L=1\mu F$ ,  $T_A=25^\circ C$ , for only one channel, unless otherwise noted.

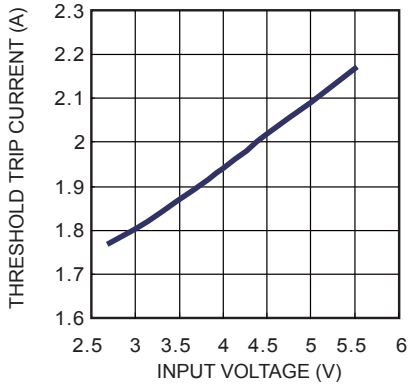
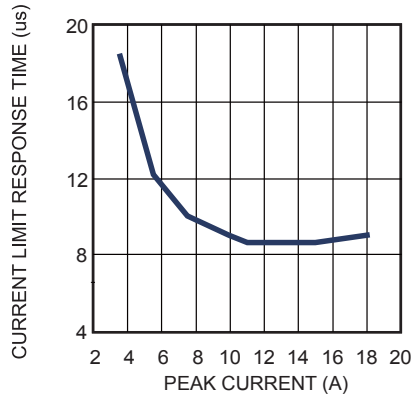
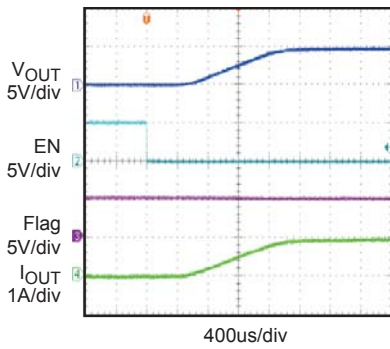
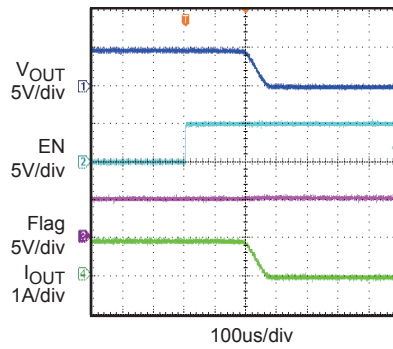
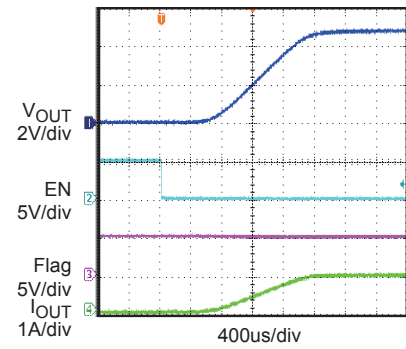
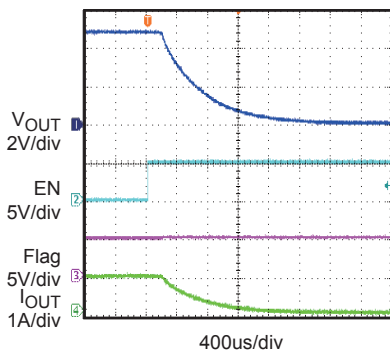
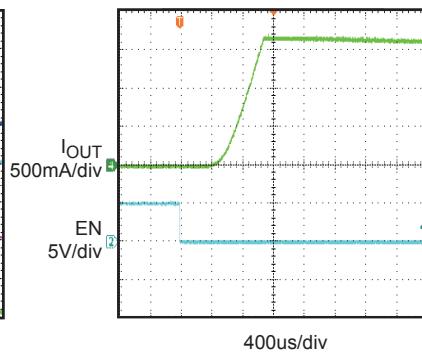
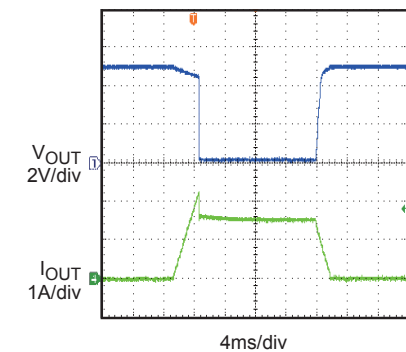
**Threshold Trip Current vs. Input Voltage**

**Current Limit Response Time vs. Peak Current**

**Turn On Delay and Rise Time with 1μF Load**
 $I_{OUT}=1A$ 

**Turn Off Delay and Fall Time with 1μF Load**
 $I_{OUT}=1A$ 

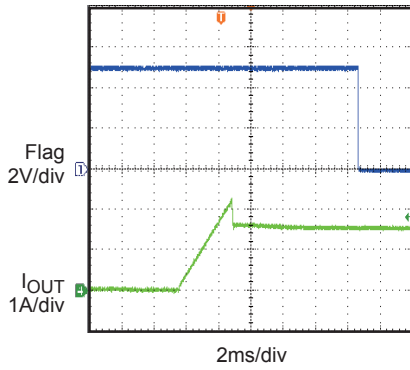
**Turn On Delay and Rise Time with 100uF Load**
 $I_{OUT}=1A$ ,  $C_L=100\mu F$ 

**Turn Off Delay and Fall Time with 100μF Load**
 $I_{OUT}=1A$ ,  $C_L=100\mu F$ 

**Short Circuit Current, Device Enabled into Short**

**Threshold Trip Current with Ramped Load on Enabled Device**

**TYPICAL PERFORMANCE CHARACTERISTICS (continued)**

$V_{IN}=5V$ ,  $C_L=1\mu F$ ,  $T_A=25^\circ C$ , for only one channel, unless otherwise noted.

**Ramped Load on Enabled Device**



**Inrush Current with Different Load Capacitance**  
 $I_{OUT}=1A$

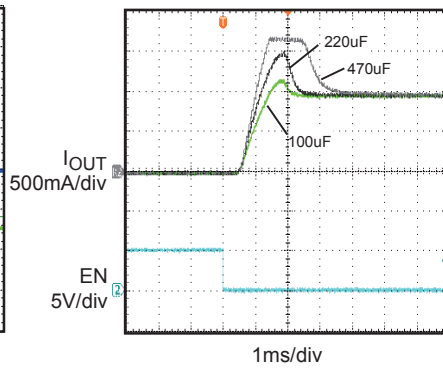

**1Ω Load Connected to Enabled Device**

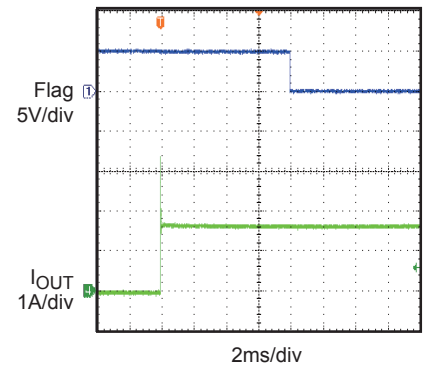

FUNCTION BLOCK DIAGRAM

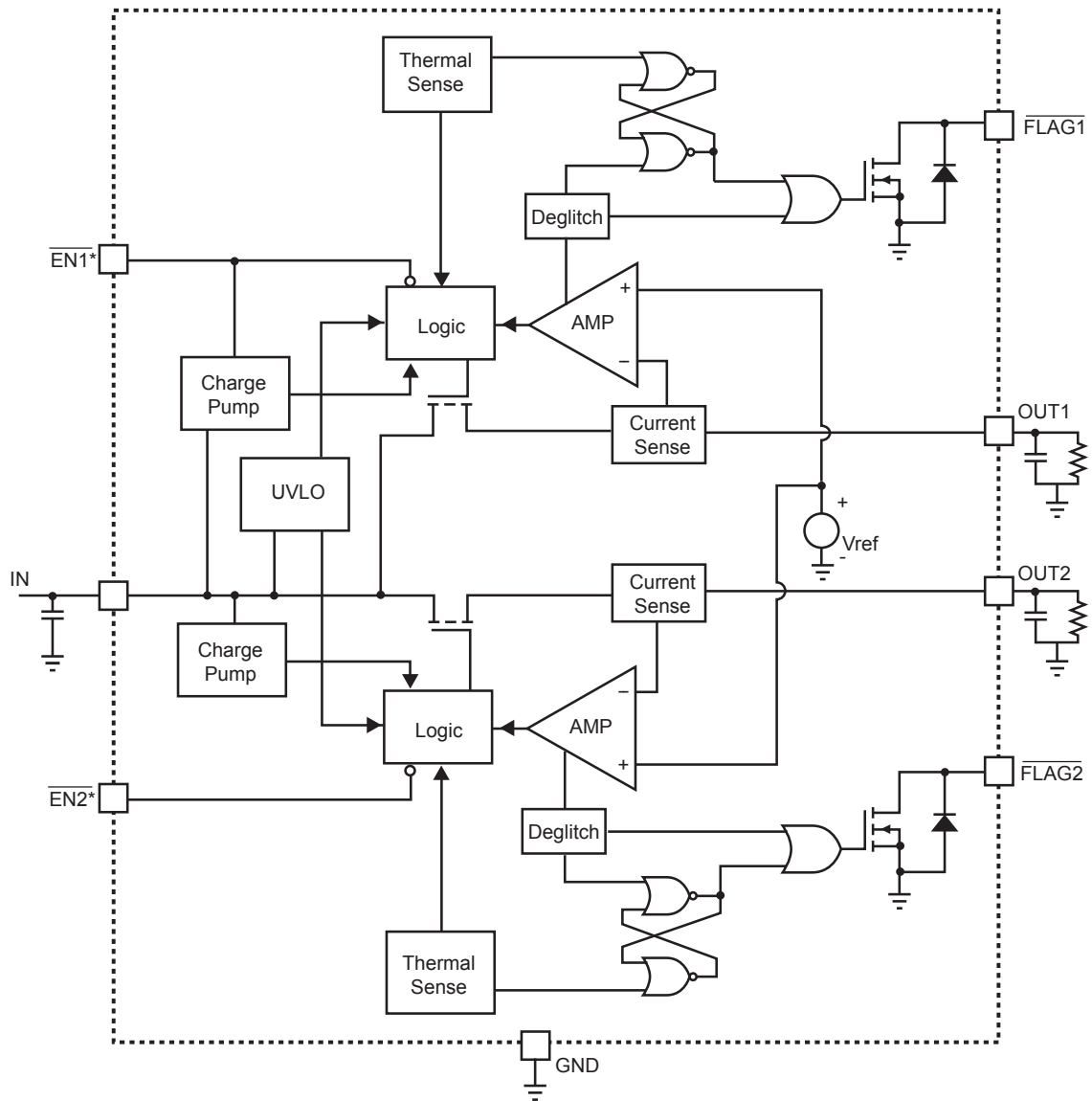

\* EN is active high for MP62341

Figure 2—Functional Block Diagram



## DETAILED DESCRIPTION

### Over Current

When the load exceeds trip current (minimum threshold current triggering constant-current mode) or a short is present, MP62340/MP62341 switches into to a constant-current mode (current limit value). MP62340/MP62341 will be shutdown only if the over current condition stays long enough to trigger thermal protection.

Trigger over current protection for different overload conditions occurring in applications:

- 1) The output has been shorted or overloaded before the device is enabled or input applied. MP62340/MP62341 detects the short or overload and immediately switches into a constant-current mode.
- 2) A short or an overload occurs after the device is enabled. After the current-limit circuit has been tripped (reached the trip current threshold), the device switches into constant-current mode. However, high current may flow for a short period of time before the current-limit circuit can react.
- 3) Output current has been gradually increased beyond the recommended operating current. The load current rises until the trip current threshold is reached or until the thermal limit of the device is exceeded. MP62340/MP62341 is capable of delivering current up to the trip current threshold without damaging the device. Once the trip threshold has been reached, the device switches into its constant-current mode.

### Flag Response

The FLAG pin is an open drain configuration. This FAULT will report a fail mode after an 8ms deglitch timeout. This is used to ensure that no false fault signals are reported. This internal deglitch circuit eliminates the need for extend components. The FLAG pin is not deglitched during an over temp. or voltage lockout.

### Thermal Protection

The purpose of thermal protection is to prevent damage in the IC by allowing exceptive current to flow and heating the junction. The die temp. is internally monitored until the thermal limit is reached. Once this temp. is reached, the switch will turn off and allow the chip to cool. The switch has a built-in hysteresis.

### Under-voltage Lockout (UVLO)

This circuit is used to monitor the input voltage to ensure that the MP62340/MP62341 is operating correctly. This UVLO circuit also ensures that there is no operation until the input voltage reaches the minimum spec.

### Enable

The logic pin disables the chip to reduce the supply current. The device will operate once the enable signal reaches the appropriate level. The input is compatible with both COMS and TTL.

## APPLICATION INFORMATION

### Power-Supply Considerations

Over 10 $\mu$ F capacitor between IN and GND is recommended. This precaution reduces power-supply transients that may cause ringing on the

input and improves the immunity of the device to short-circuit transients.

In order to achieve smaller output load transient, placing a high-value electrolytic capacitor on the output pin(s) is recommended when the output load is heavy.

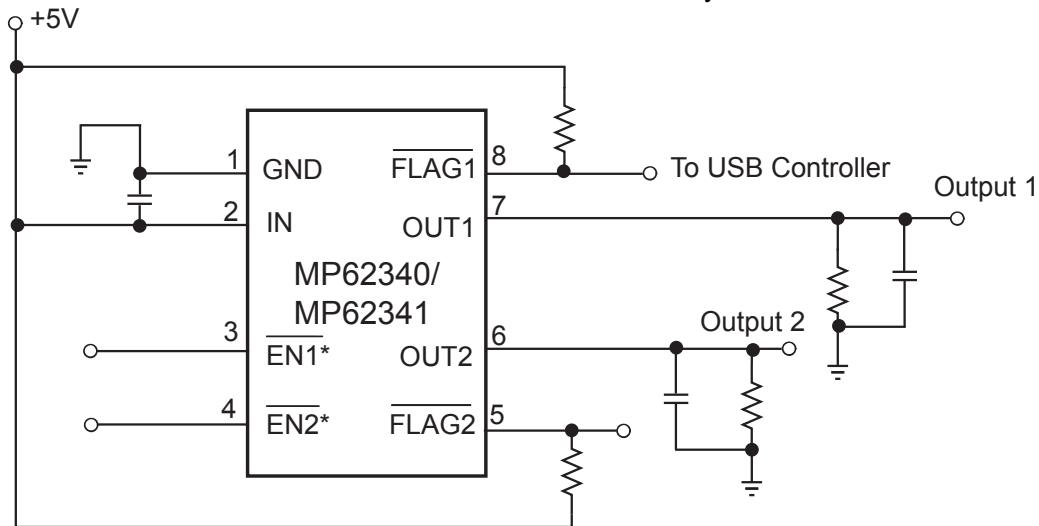

\* EN is active high for MP62341

**Figure 3—Application Circuit**

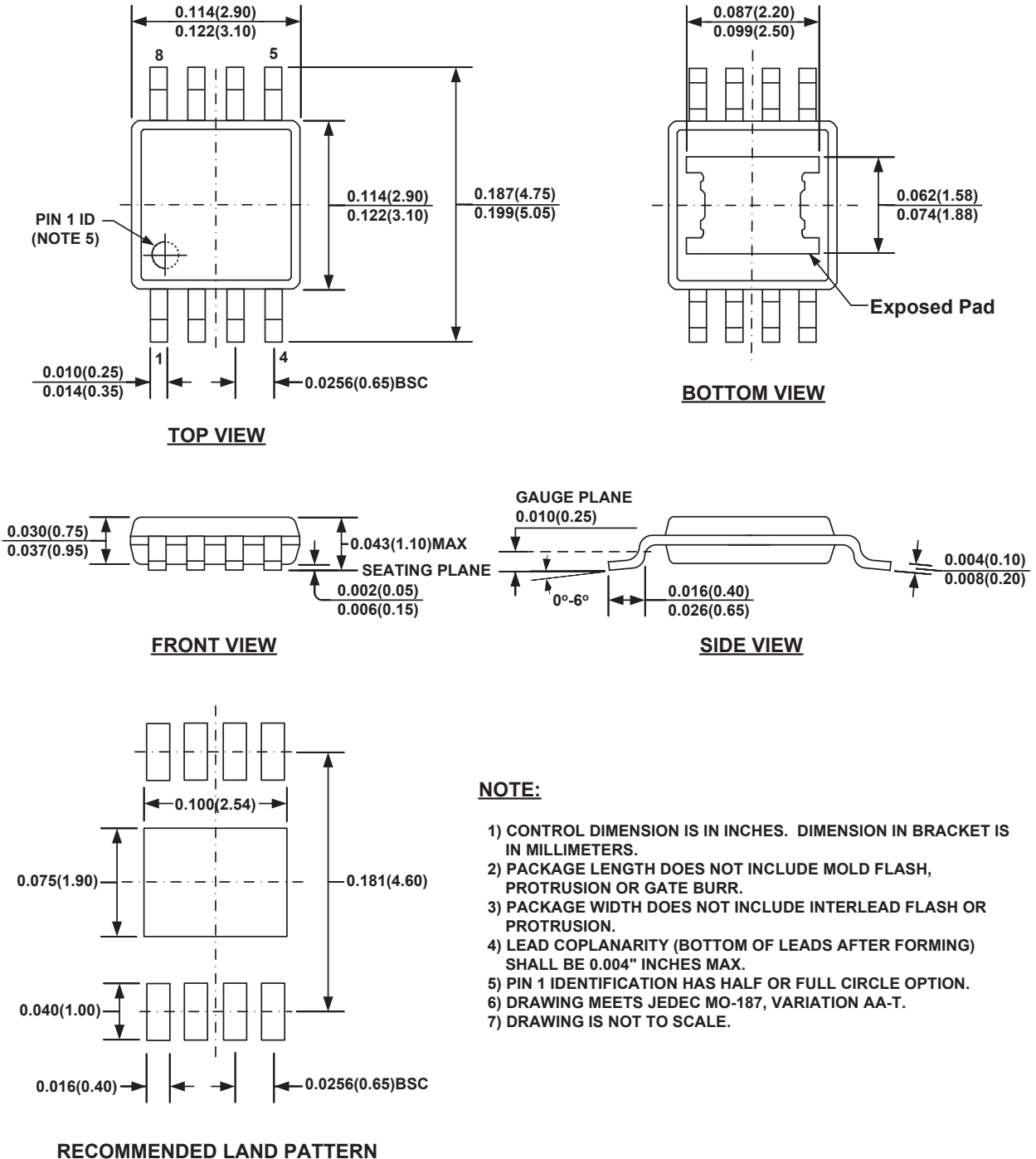
**PACKAGE INFORMATION**
**MSOP8E (EXPOSED PAD)**

**NOTE:**

- 1) CONTROL DIMENSION IS IN INCHES. DIMENSION IN BRACKET IS IN MILLIMETERS.
- 2) PACKAGE LENGTH DOES NOT INCLUDE MOLD FLASH, PROTRUSION OR GATE BURR.
- 3) PACKAGE WIDTH DOES NOT INCLUDE INTERLEAD FLASH OR PROTRUSION.
- 4) LEAD COPLANARITY (BOTTOM OF LEADS AFTER FORMING) SHALL BE 0.004" INCHES MAX.
- 5) PIN 1 IDENTIFICATION HAS HALF OR FULL CIRCLE OPTION.
- 6) DRAWING MEETS JEDEC MO-187, VARIATION AA-T.
- 7) DRAWING IS NOT TO SCALE.

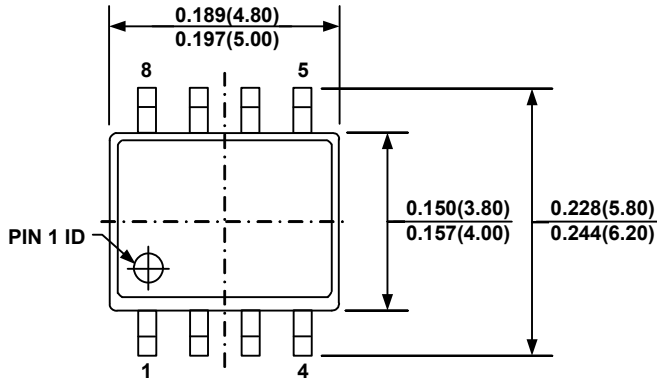
**SOIC8**

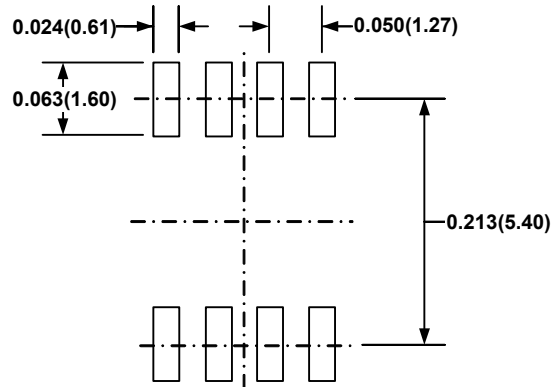

**TOP VIEW**



**RECOMMENDED LAND PATTERN**

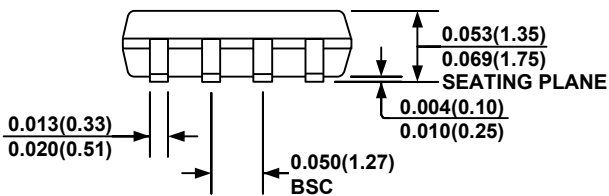

**FRONT VIEW**

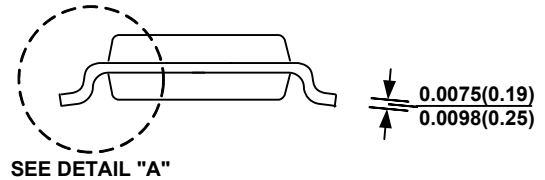

**SIDE VIEW**

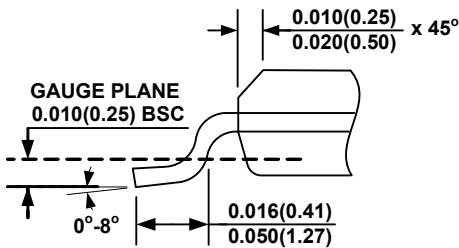

**DETAIL "A"**

**NOTE:**

- 1) CONTROL DIMENSION IS IN INCHES. DIMENSION IN BRACKET IS IN MILLIMETERS.
- 2) PACKAGE LENGTH DOES NOT INCLUDE MOLD FLASH, PROTRUSIONS OR GATE BURRS.
- 3) PACKAGE WIDTH DOES NOT INCLUDE INTERLEAD FLASH OR PROTRUSIONS.
- 4) LEAD COPLANARITY (BOTTOM OF LEADS AFTER FORMING) SHALL BE 0.004" INCHES MAX.
- 5) DRAWING CONFORMS TO JEDEC MS-012, VARIATION AA.
- 6) DRAWING IS NOT TO SCALE.

**NOTICE:** The information in this document is subject to change without notice. Users should warrant and guarantee that third party Intellectual Property rights are not infringed upon when integrating MPS products into any application. MPS will not assume any legal responsibility for any said applications.