

DESCRIPTION

The MP161 integrates a 700V switching regulator, a low-dropout linear regulator, and two channel relay drivers. The MP161 also has a special standby mode to minimize standby power. The MP161 is designed for home automation, industrial automation, and any other applications that adopt relays and MCUs.

The 700V switching regulator adopts constant voltage (CV) regulation with internal loop compensation. Light-load efficiency is optimized by proper modulation of the switching frequency and peak current. Various protections are also included to guarantee reliable operation.

The integrated low-dropout linear regulator is able to operate with an input up to 30V. The output voltage is fixed at either 5V or 3.3V. The MP161 also has over-temperature protection (OTP).

Built-in relay drivers are intended to drive up to two relays using the switching regulator output. Freewheeling diodes are integrated to cut down external components.

When standby mode enabled, the switching regulator output voltage is lowered to reduce power consumption.

The MP161 is available in a SOIC-16 package.

Part Number	Typical Switching Regulator Peak Current Limit	Typical HV MOSFET $R_{DS(ON)}$	LDO Output Voltage
MP161A-33	240mA	17Ω	3.3V
MP161A-5			5V
MP161B-33	420mA	14Ω	3.3V
MP161B-5			5V
MP161C-33*	660mA	13.5Ω	3.3V
MP161C-5*			5V

* Parts are under development. All following descriptions and data related to these parts are subject to change.

FEATURES

700V Switching Regulator

- Integrated 700V MOSFET and Current Source
- Constant Voltage (CV) Regulation with Internal Loop Compensation
- Optimized Light-Load Efficiency by Frequency Modulation
- Standby Mode
- Anti-Audible Noise Operation by Peak Current Modulation
- Adjustable or Fixed 12V Output
- Low Operating Current
- Over-Temperature Protection (OTP), Short-Circuit Protection (SCP), Overload Protection (OLP), Over-Voltage Protection (OVP) and Brown-Out Protection (BOP)

Low-Dropout Linear Regulator

- Up to 30V Input Voltage
- Fixed Output, with 3.3V and 5V Options
- Over-Temperature Protection (OTP)

Relay Driver

- 2Ω On State Resistance
- Rail Voltage up to 30V
- Integrated Freewheeling Diode
- Nominal Off Driver

APPLICATIONS

- Home/Industrial Automation
- Small Appliances

All MPS parts are lead-free, halogen-free, and adhere to the RoHS directive. For MPS green status, please visit the MPS website under Quality Assurance. "MPS" and "The Future of Analog IC Technology" are registered trademarks of Monolithic Power Systems, Inc.

TYPICAL APPLICATION

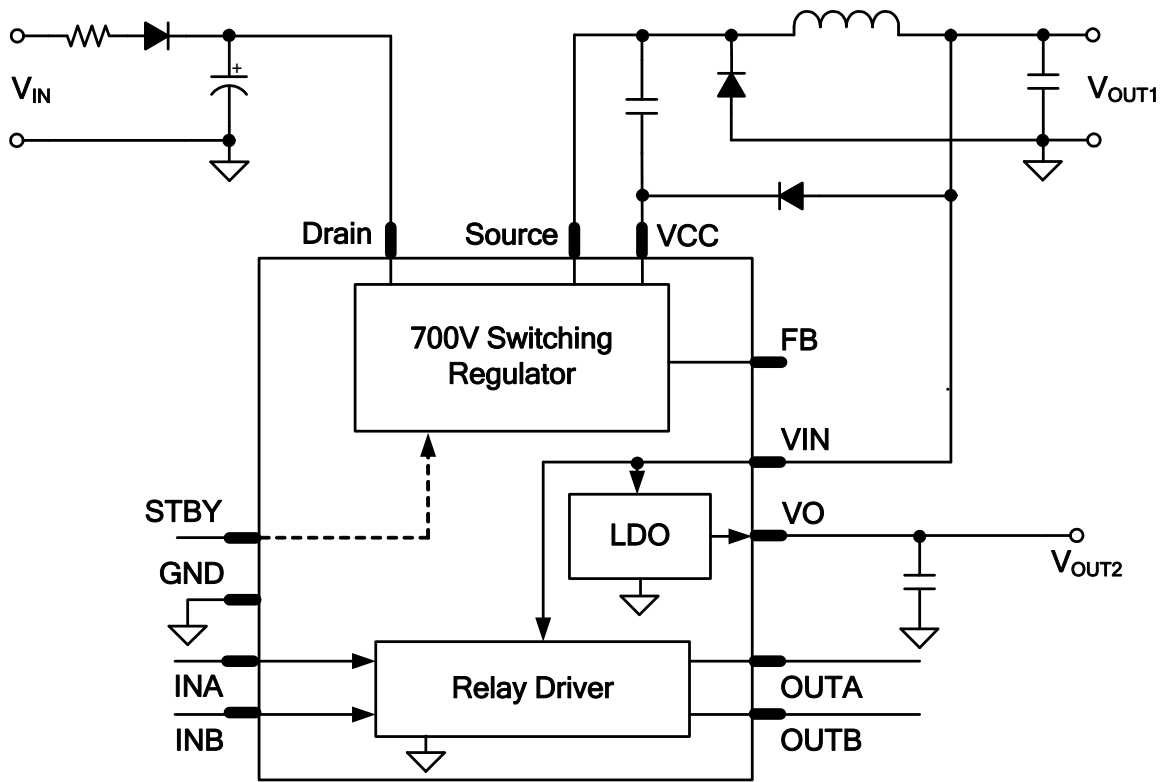



ORDERING INFORMATION

Part Number*	Package	Top Marking
MP161AGS-5	SOIC-16	See Below
MP161AGS-33	SOIC-16	See Below
MP161BGS-5	SOIC-16	See Below
MP161BGS-33	SOIC-16	See Below

* For Tape & Reel, add suffix -Z (e.g. MP161AGS-5-Z)

TOP MARKING (MP161AGS-5)

MPS YYWW
MP161A-5
LLLLLLLLLL

MPS: MPS prefix
YY: Year code
WW: Week code
MP161A-5: Part number
LLLLLLLLLL: Lot number

TOP MARKING (MP161AGS-33)

MPS YYWW
MP161A-33
LLLLLLLLLL

MPS: MPS prefix
YY: Year code
WW: Week code
MP161A-33: Part number
LLLLLLLLLL: Lot number

TOP MARKING (MP161BGS-5)

MPS YYWW
MP161B-5
LLLLLLLLLL

MPS: MPS prefix
YY: Year code
WW: Week code
MP161B-5: Part number
LLLLLLLLLL: Lot number

TOP MARKING (MP161BGS-33)

MPS YYWW
MP161B-33
LLLLLLLLL

MPS: MPS prefix
 YY: Year code
 WW: Week code
 MP161B-33: Part number
 LLLLLLLLL: Lot number

PACKAGE REFERENCE

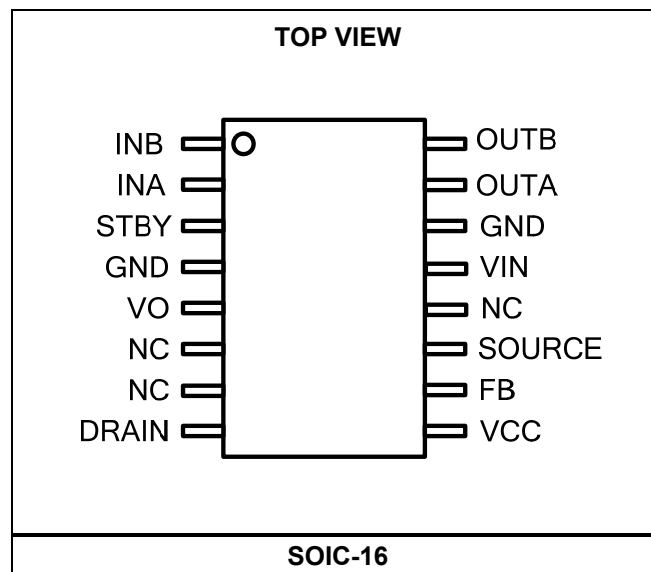

ABSOLUTE MAXIMUM RATINGS ⁽¹⁾

DRAIN to SOURCE -0.3V to 700V
 VCC to SOURCE -0.3V to 30V
 FB to SOURCE -0.3V to 7V
 SOURCE to GND..... -15V to 700V
 STBY, INA, INB, VO to GND -0.3V to 7V
 VIN, OUTA, OUTB to GND -0.3V to 30V
 Continuous power dissipation (T_A = +25°C) ⁽²⁾
 1.56W
 Junction temperature 150°C
 Lead temperature..... 260°C
 Storage temperature -60°C to +150°C
 ESD charged device model 2.0kV

Recommended Operating Conditions ⁽³⁾

Junction temperature (T_J) -40°C to +125°C

Thermal Resistance ⁽⁴⁾	θ_{JA}	θ_{JC}
SOIC-16	80	30 ... °C/W

NOTES:

- 1) Exceeding these ratings may damage the device.
- 2) The maximum allowable power dissipation is a function of the maximum junction temperature T_J(MAX), the junction-to-ambient thermal resistance θ_{JA}, and the ambient temperature T_A. The maximum allowance continuous power dissipation at any ambient temperature is calculated by P_D(MAX)=(T_J(MAX)-T_A)/θ_{JA}. Exceeding the maximum allowance power dissipation produces an excessive die temperature, causing the regulator to go into thermal shutdown. Internal thermal shutdown circuit protects the device from permanent damage.
- 3) The device is not guaranteed to function outside of its operating conditions.
- 4) Measured on JESD51-7, 4-layer PCB.

ELECTRICAL CHARACTERISTICS

VCC = 12V, VIN = 12V, T_J = -40°C - 125°C, min and max values are guaranteed by characterization, typical values are tested under T_J = 25°C, unless otherwise specified. ⁽⁵⁾

Parameter	Symbol	Condition	Min	Typ	Max	Units
High-Voltage (HV) Current Source and Internal MOSFET (DRAIN)						
Internal HV current source supply current for VCC regulation	I _{regulator}	VCC = 4V, V _{DRAIN} = 100V	2.2	4.1	6	mA
DRAIN leakage current	I _{Leak}	V _{DRAIN} = 400V		10	17	μA
Breakdown voltage	V _{(BR)DSS}	T _J = 25°C	700			V
On resistance	R _{on}	MP161AGS-33, MP161AGS-5, T _J = 25°C		17	20.5	Ω
		MP161AGS-33, MP161AGS-5, T _J = 125°C		24	28	
		MP161BGS-33, MP161BGS-5, T _J = 25°C		14	17.5	
		MP161BGS-33, MP161BGS-5, T _J = 125°C		21	25	
		MP161CGS-33, MP161CGS-5, T _J = 25°C		13.5		
Maximum on time	t _{maxon}	MP161AGS-33, MP161AGS-5, MP161BGS-33, MP161BGS-5, MP161CGS-33, MP161CGS-5	21	25	30	μs
Minimum off time	t _{minoff}	MP161AGS-33, MP161AGS-5,	7	9.5	12	μs
		MP161BGS-33, MP161BGS-5, MP161CGS-33, MP161CGS-5	10	12.5	15.3	
OLP delay cycles		t _{off} = t _{minoff}		8192		
Supply Voltage Management (VCC)						
Internal HV current source turn off threshold	V _{HVoff}		4.4	4.65	4.9	V
Internal HV current source turn on threshold	V _{HVon}		3.85	4.1	4.3	V
UVLO upper threshold	V _{CCH}			V _{HVoff}		V
UVLO lower threshold	V _{CCL}		3.4	3.6	3.75	V
Hysteresis of HV current source turn on threshold and UVLO lower threshold		V _{HVon} - V _{CCL}	350			mV
Threshold to reset protections	V _{CCpro}			2.4	2.7	V
Regulating voltage (threshold to turn on MOSFET)	V _{CCref}	FB open	11.9	12.5	13	V
Regulating reference in standby mode	V _{CCSTBY}		5.4	5.7	6	V
IC consumption	I _{CC}	f _s = 50kHz			600	μA
IC consumption, latch-off phase	I _{CCL}	VCC = 5V		20	28	μA
Feedback (FB)						
Reference voltage (threshold to turn on MOSFET)	V _{ref}		1.175	1.225	1.275	V
Internal lower resistor	R _{low}			450		kΩ

ELECTRICAL CHARACTERISTICS (continued)

VCC = 12V, VIN = 12V, T_J = -40°C - 125°C, min and max values are guaranteed by characterization, typical values are tested under T_J = 25°C, unless otherwise specified. ⁽⁵⁾

Parameter	Symbol	Condition	Min	Typ	Max	Units
Internal upper resistor	R _{up}			4.1		MΩ
Internal Current Sense (SOURCE)						
Peak current limit	I _{Limit}	MP161AGS-33, MP161AGS-5, T _J = 25°C	218	240	262	mA
		MP161BGS-33, MP161BGS-5, T _J = 25°C	380	420	460	
		MP161CGS-33, MP161CGS-5, T _J = 25°C		660		
Leading-edge blanking	t _{LEB1}			350		ns
SCP threshold	I _{SCP}	MP161AGS-33, MP161AGS-5, T _J = 25°C	455	525	590	mA
		MP161BGS-33, MP161BGS-5, T _J = 25°C	530	620	710	
		MP161CGS-33, MP161CGS-5, T _J = 25°C		990		
Leading-edge blanking for SCP ⁽⁶⁾	t _{LEB2}			180		ns
Control Inputs (STBY, INA, INB)						
Low-level input voltage	V _{IL-u}				0.8	V
High-level input voltage	V _{IH-u}		2.0			V
Input hysteresis	V _{HYS_INX}		0.23			V
STBY input hysteresis	V _{HYS_STBY}		0.18			V
Internal pull-down resistor	R _{pull-down}			450		kΩ
Relay Drivers (OUTA, OUTB)						
Breakdown voltage	V _{(BR)RD}		30			V
MOSFET on state resistance	R _{on}	I _{OUTA/B} = 50mA		2	3	Ω
Off state leakage current	I _{LK(off)}	OUTA/B=30V			1	μA
Turn-on delay	t _{d(on)}			50		ns
Turn-off delay	t _{d(off)}			100		ns
Voltage drop on freewheeling diode	V _F	I _F = 100mA, OUTA/B to VIN		1		V

ELECTRICAL CHARACTERISTICS (continued)

VCC = 12V, VIN = 12V, T_J = -40°C - 125°C, min and max values are guaranteed by characterization, typical values are tested under T_J = 25°C, unless otherwise specified. ⁽⁵⁾

Parameter	Symbol	Condition	Min	Typ	Max	Units
Linear Regulator (VIN, VO)						
Input over-voltage protection	V _{OVP}		26.5	28	29	V
OVP discharge current	I _{OVP}	VIN = 30V		5		mA
VIN UVLO upper threshold	V _{INH}		3.9	4.2	4.5	V
VIN UVLO lower threshold	V _{INL}		3.5	3.75	4	V
Output voltage	V _O	MP161AGS-5, MP161BGS-5, MP161CGS-5	4.9	5	5.1	V
		MP161AGS-33, MP161BGS-33, MP161CGS-33	3.234	3.3	3.366	
Quiescent current	I _{QIN}	MP161AGS-5, MP161BGS-5, MP161CGS-5, VIN = 5.5V			240	μA
Line regulation ⁽⁷⁾		MP161AGS-5, MP161BGS-5, MP161CGS-5, I _{OUT} = 1mA, VIN = 5.5V-24V		0.005	0.01	%/V
Load regulation ⁽⁸⁾		MP161AGS-5, MP161BGS-5, MP161CGS-5, I _{OUT} = 1mA to 100mA		0.005	0.01	%/mA
Dropout voltage	V _{Drop}	MP161AGS-5, MP161BGS-5, MP161CGS-5, I _{OUT} = 50mA, VIN to VO, VIN = 4.9V			300	mV
Over-Temperature Protection						
Thermal shutdown threshold ⁽⁶⁾				150		°C
Thermal shutdown recovery hysteresis ⁽⁶⁾				30		°C

NOTES:

5) The values on DRAIN, VCC, and FB are all referenced to SOURCE. The values on VIN, VO, INA, INB, OUTA, OUTB, and STBY are all referenced to GND, unless otherwise specified.

6) Guaranteed by characterization.

$$7) \text{ Line regulation} = \frac{|V_{O[VIN(MAX)]} - V_{O[VIN(MIN)]}|}{(VIN_{(MAX)} - VIN_{(MIN)}) \times V_{O(NOM)}} \times (\% / V)$$

$$8) \text{ Load regulation} = \frac{|V_{O[IOUT(MAX)]} - V_{O[IOUT(MIN)]}|}{(I_{OUT(MAX)} - I_{OUT(MIN)}) \times V_{O(NOM)}} \times (\% / mA)$$

TYPICAL CHARACTERISTICS

$I_{regulator}$ @ $V_{DRAIN} = 100V$ vs. Temperature

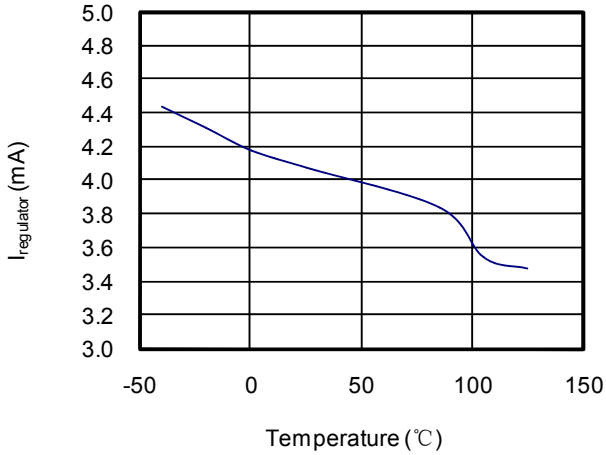

$R_{DS(ON)}$ vs. Temperature

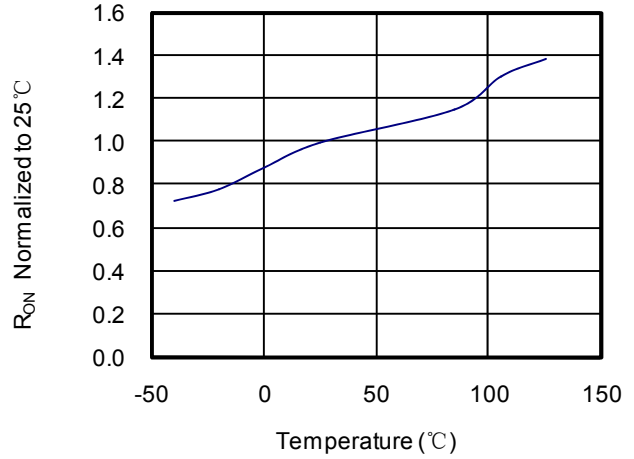

T_{minoff} (MP161Ax) vs. Temperature

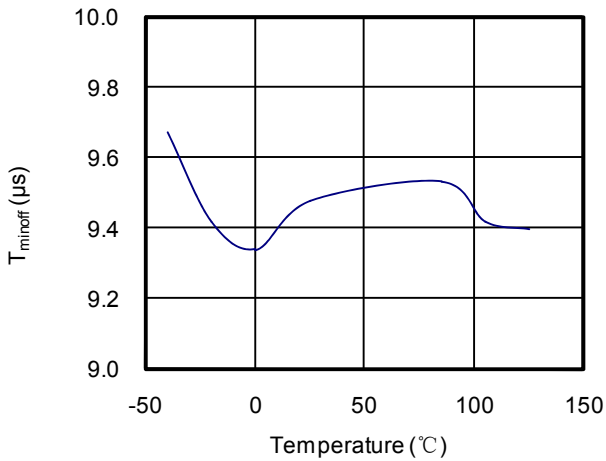

T_{maxon} (MP161Ax) vs. Temperature

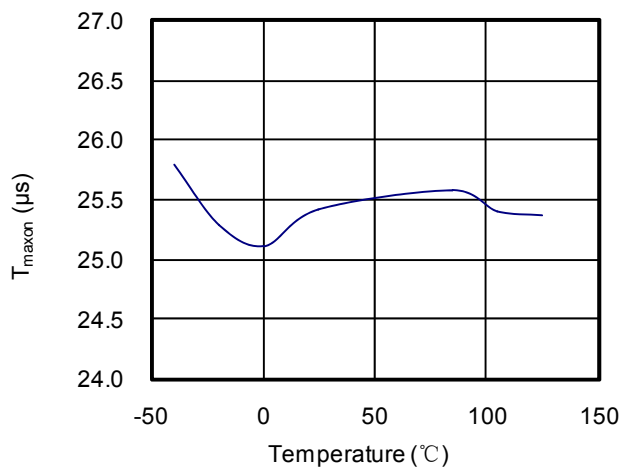

V_{CCREF} vs. Temperature

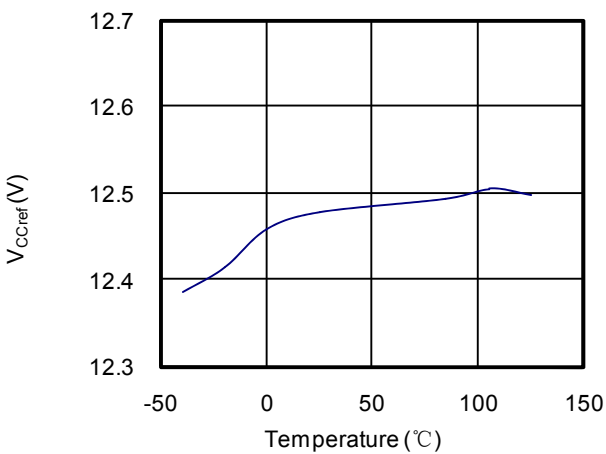

V_{CCSTBY} vs. Temperature

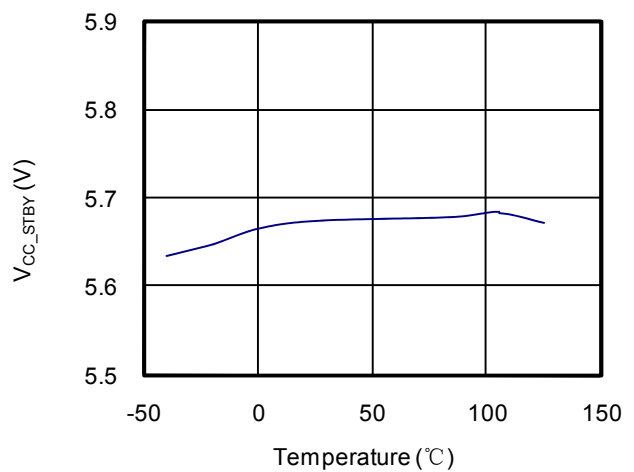

TYPICAL CHARACTERISTICS (continued)

T_{LEB1} vs. Temperature

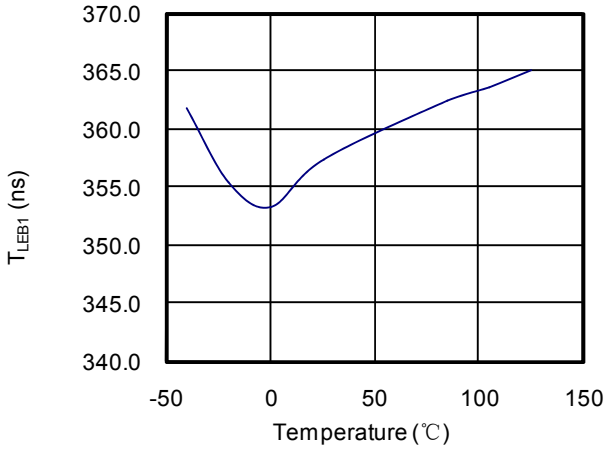

V_{REF} vs. Temperature

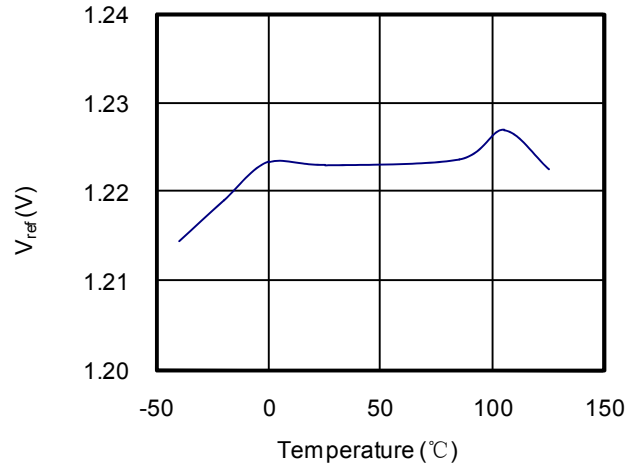

$V_{(BR)RD}$ vs. Temperature

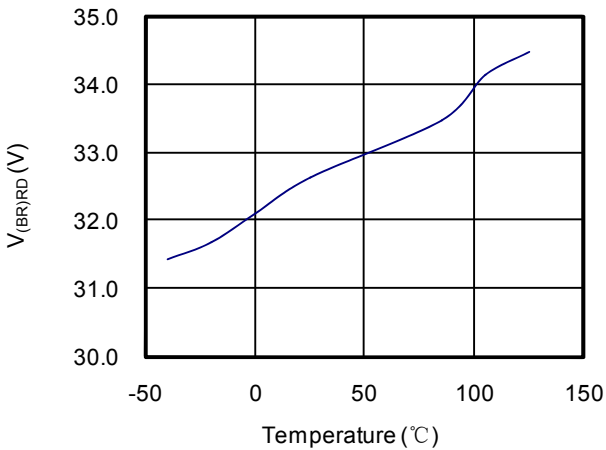

V_{OVP} vs. Temperature vs.

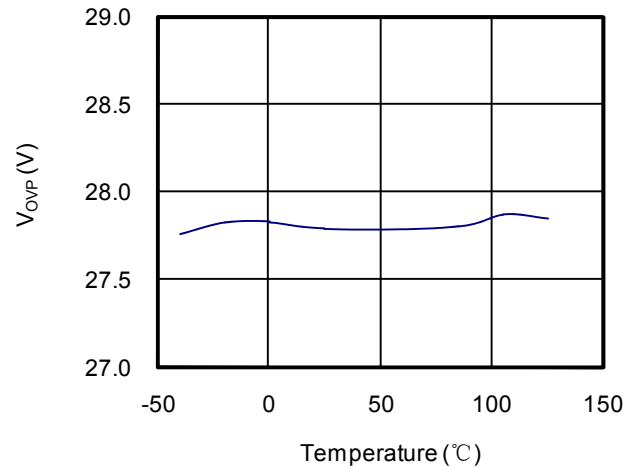

I_{QIN} @ $V_{IN} = 5.5V$ vs. Temperature

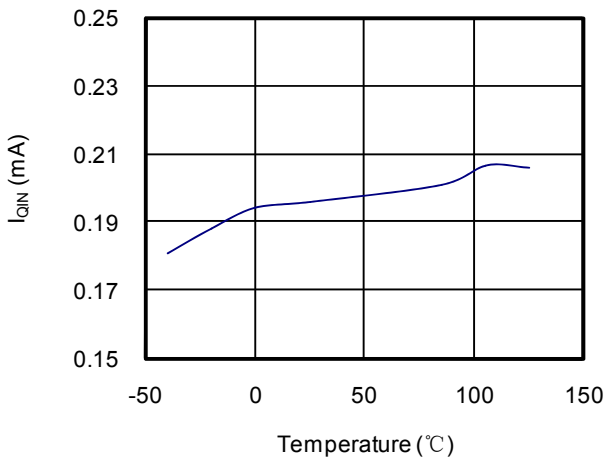

V_O (MP161x-5) vs. Temperature

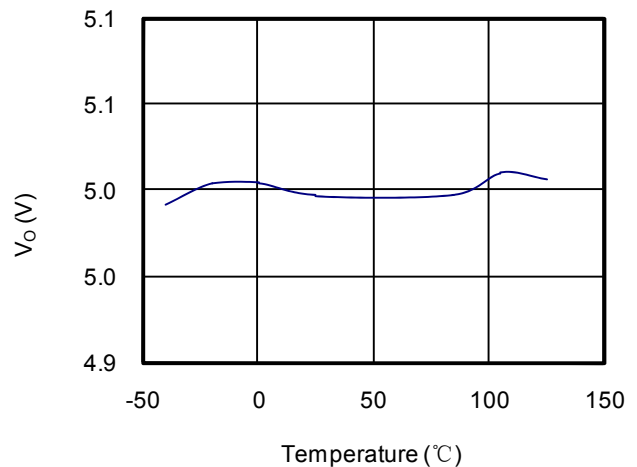

TYPICAL PERFORMANCE CHARACTERISTICS

Performance waveforms are tested with the evaluation board in the Design Example section.
 $V_{IN} = 230V$, $V_{OUT1} = 12V$, $I_{OUT1} = 70mA$, $V_{OUT2} = 5V$, $I_{OUT2} = 50mA$, $T_A = 25^\circ C$, unless otherwise noted.

Normal Operation

Full Load

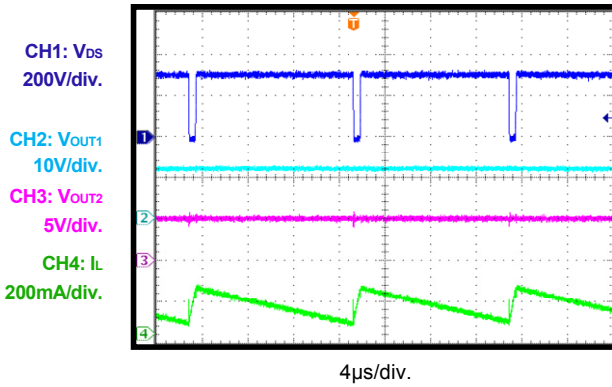

Start-Up

No Load

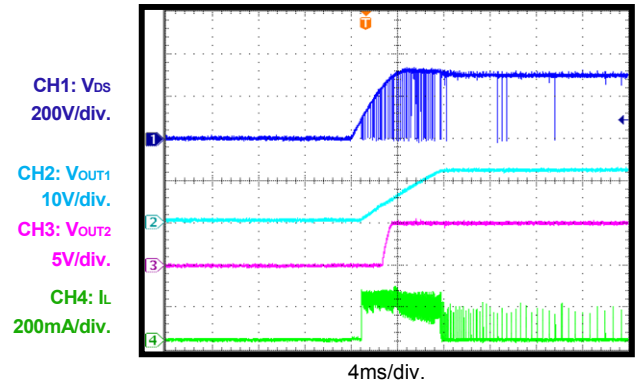

Start-Up

Full Load

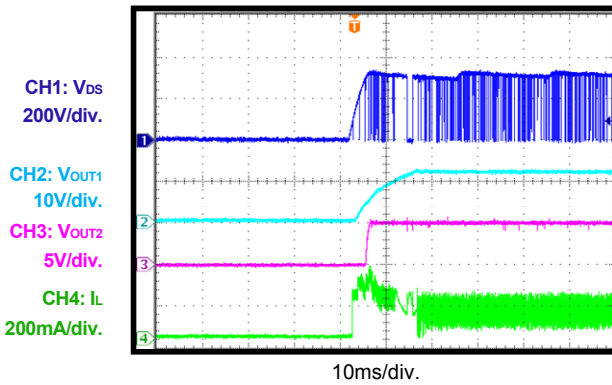

V_{OUT1} Short Circuit

Full Load

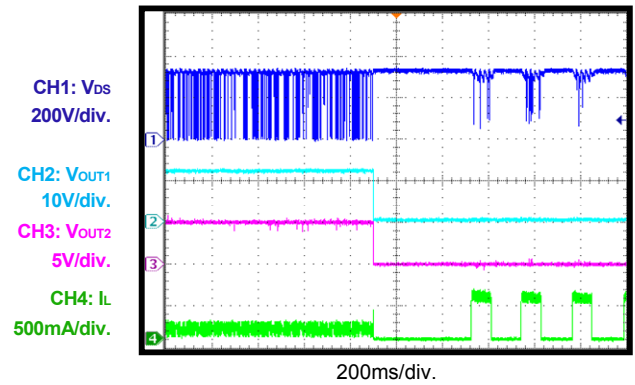

V_{OUT2} Short Circuit

Full Load

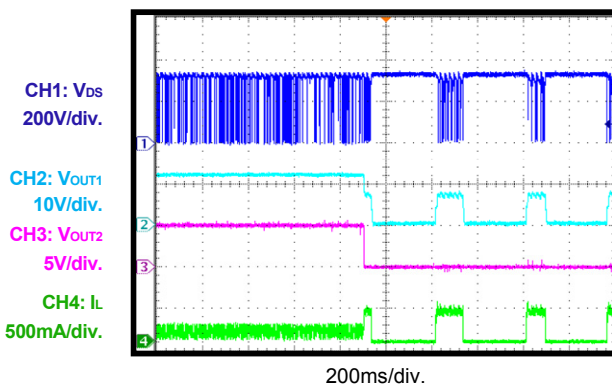

V_{OUT1} OVP

No Load

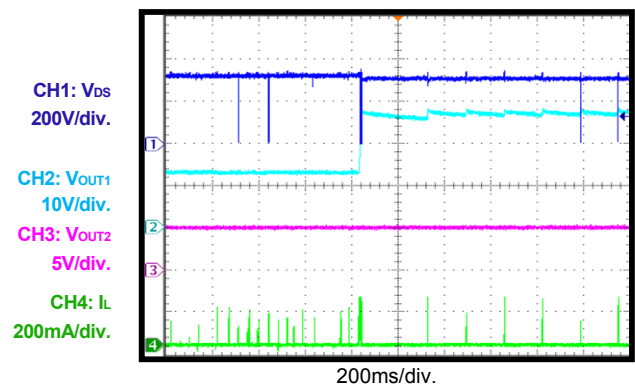

TYPICAL PERFORMANCE CHARACTERISTICS (continued)

Performance waveforms are tested with the evaluation board in the Design Example section.
 $V_{IN} = 230V$, $V_{OUT1} = 12V$, $I_{OUT1} = 70mA$, $V_{OUT2} = 5V$, $I_{OUT2} = 50mA$, $T_A = 25^\circ C$, unless otherwise noted.

V_{OUT1} OLP
Full Load

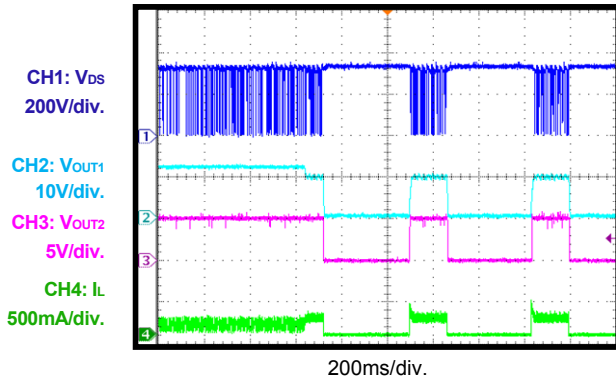

Standby Entry
No Load

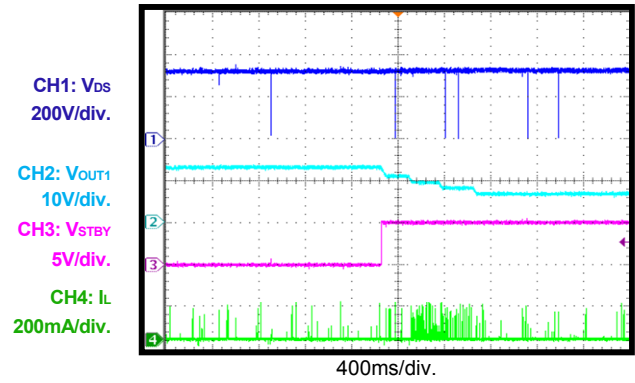

Standby Recovery
No Load

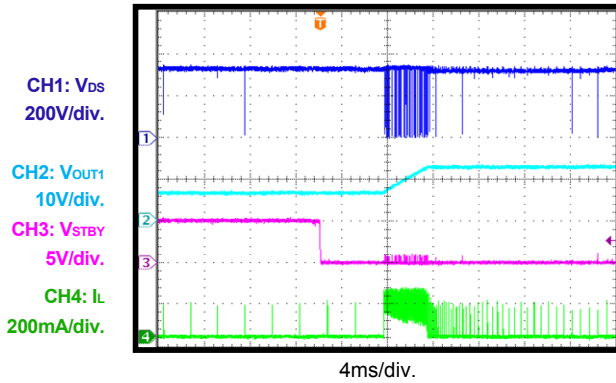

Standby Entry
 $I_{OUT1} = 0A$, $I_{OUT2} = 50mA$

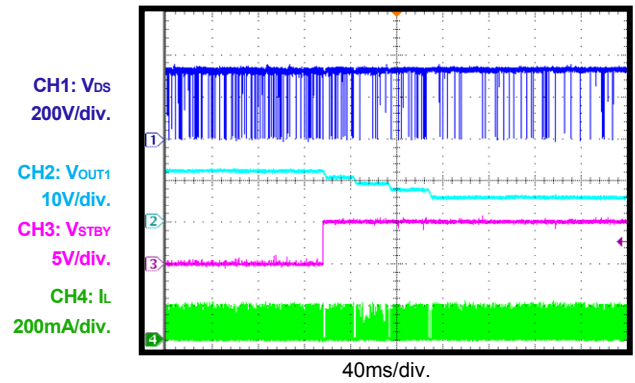

Standby Recovery
 $I_{OUT1} = 0A$, $I_{OUT2} = 50mA$

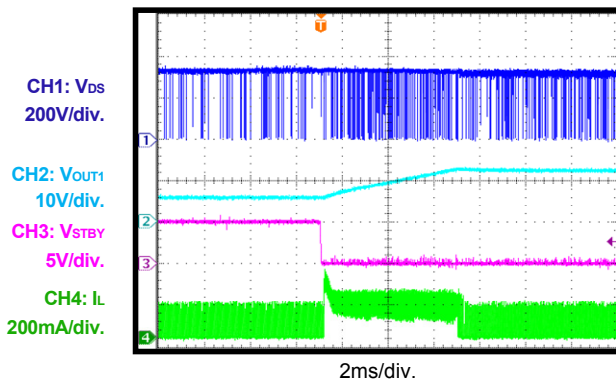

Relay 1 Turn-On
No Load

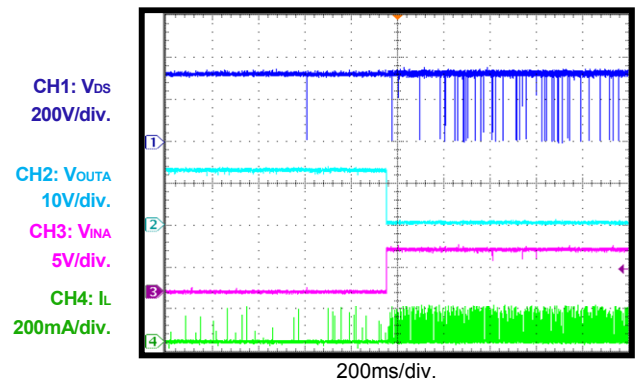

TYPICAL PERFORMANCE CHARACTERISTICS (continued)

Performance waveforms are tested with the evaluation board in the Design Example section. $V_{IN} = 230V$, $V_{OUT1} = 12V$, $I_{OUT1} = 70mA$, $V_{OUT2} = 5V$, $I_{OUT2} = 50mA$, $T_A = 25^\circ C$, unless otherwise noted.

Relay 1 Turn-Off
No Load

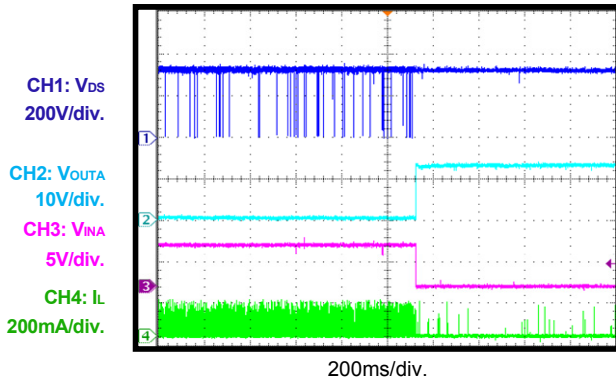

Relay 2 Turn-On
No Load

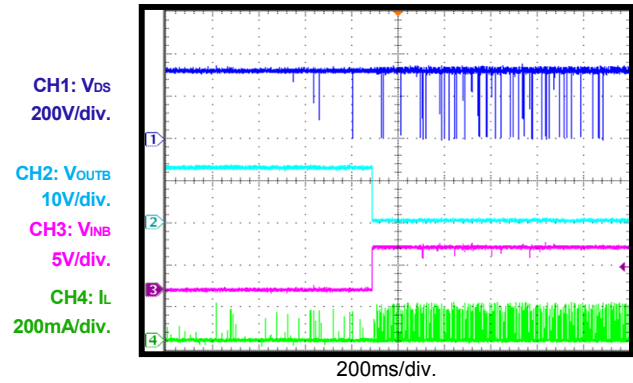

Relay 2 Turn-Off
No Load

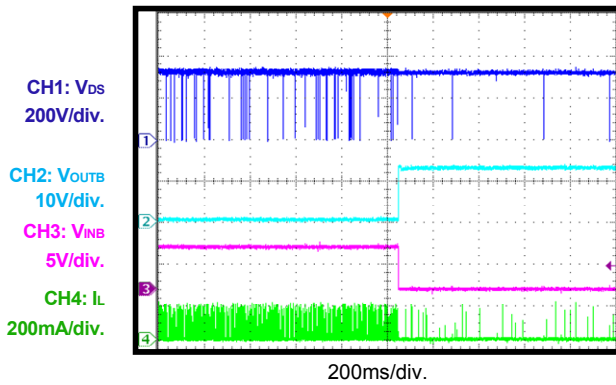

PIN FUNCTIONS

SOIC-16 Pin #	Name	Description
1	INB	Logic input for relay driver – channel B.
2	INA	Logic input for relay driver – channel A.
3	STBY	Logic input for standby mode control. Set STBY to the low-level input for normal operation. Set STBY to the high-level input for standby operation.
4, 14	GND	Ground.
5	VO	Low-dropout linear regulator output.
6, 7, 12	NC	No connection.
8	DRAIN	Drain of the internal 700V MOSFET. DRAIN is also the input of the high-voltage current source.
9	VCC	Power supply for the 700V switching regulator. VCC acts as the feedback input when the internal fixed output is enabled or in standby mode.
10	FB	Feedback input for the 700V switching regulator. Connect external resistors to FB to implement the adjustable output. Otherwise, the internal fixed output is enabled.
11	SOURCE	Source of the internal 700V MOSFET.
13	VIN	Low-dropout linear regulator input. VIN is the power supply for the standby control and relay driver circuit.
15	OUTA	Relay driver output – channel A.
16	OUTB	Relay driver output – channel B.

BLOCK DIAGRAM

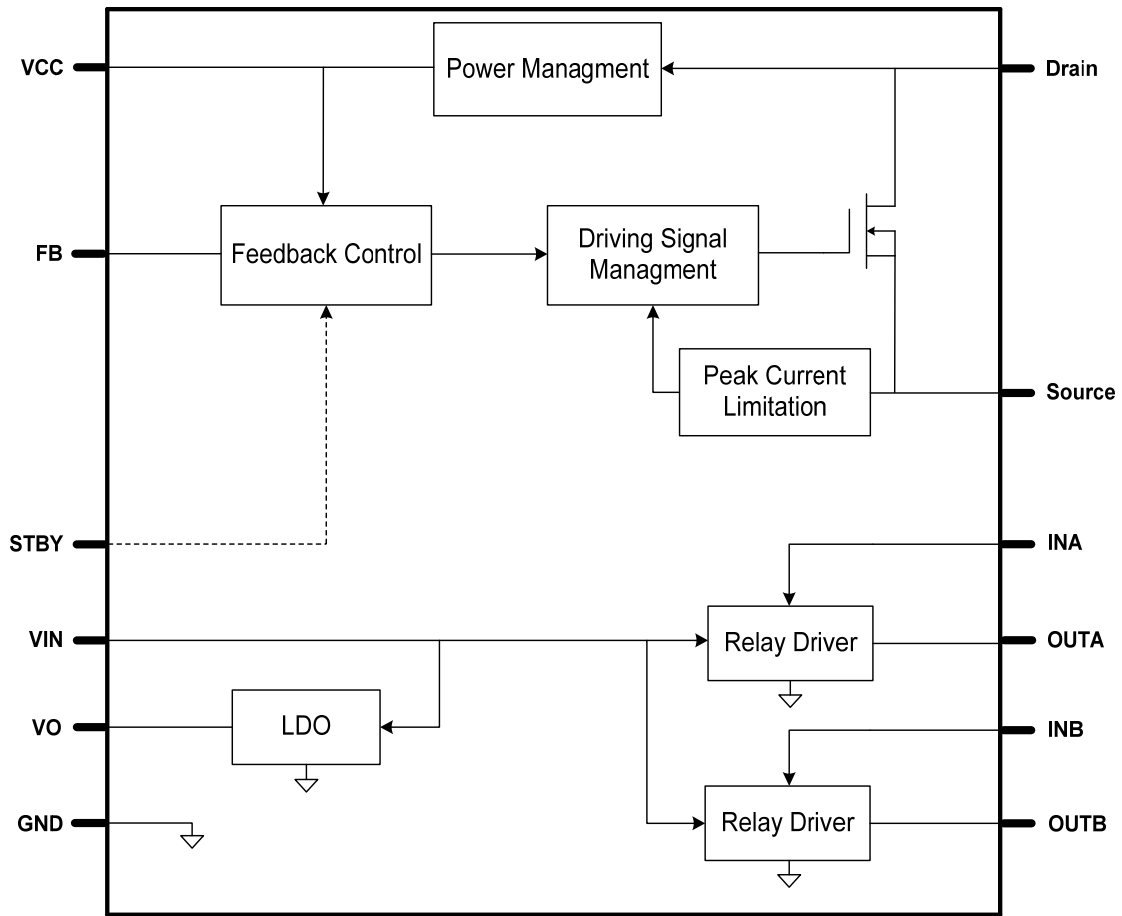

Figure 1: Functional Block Diagram

OPERATION

The MP161 integrates a 700V switching regulator, a low-dropout linear regulator, and relay drivers. The MP161 is an integrated power stage solution for home automation, industrial automation, and any other applications that adopt relays and MCUs.

High Voltage (HV) Current Source and VCC Under-Voltage Lockout (UVLO)

The internal high-voltage (HV) current source regulates VCC by drawing current from DRAIN. When VCC reaches V_{HVoff} , the IC starts switching, and the internal HV current source is turned off. The internal HV current source turns on again when VCC falls below V_{HVon} .

During start-up under normal operation, the MP161 VCC voltage is always regulated above V_{HVon} . A very small VCC capacitor can be used (in the low μ F or hundreds of nF range).

VCC under-voltage lockout (UVLO) terminates the switching when VCC is lower than V_{CCL} to prevent errors caused by an insufficient supply voltage. The IC can shut down until VCC is charged to V_{HVoff} again. This does not occur, typically, because the HV current source turns on to supply VCC as soon as VCC drops to V_{HVon} , which prevents it from dropping to V_{CCL} (see Figure 2).

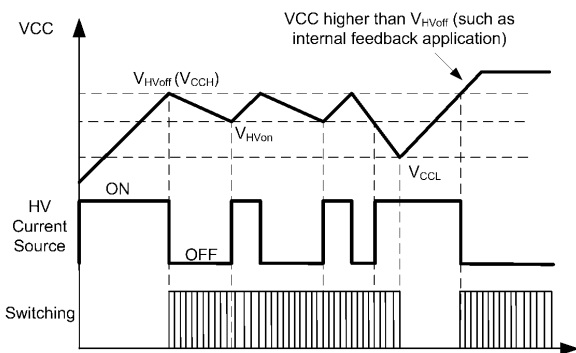

Figure 2: HV Current Source and VCC Operation

Soft Start (SS)
The MP161 starts switching with a soft-start period when the device powers on or resumes operation from a protection mode. Soft start prevents the inductor current from overshooting.

The MP161 implements soft start by decreasing the minimal off time gradually in eight steps. There are 640 switching cycles in the soft start. During soft start, short-circuit protection (SCP) and overload protection (OLP) are disabled.

Constant Voltage Operation

The MP161 integrates a 700V switching regulator that regulates the output voltage by detecting the feedback (FB). The internal MOSFET is turned on when the FB voltage (V_{FB}) is lower than the reference voltage (V_{REF}) and is turned off based on the peak-current limitation (see Figure 3). In this way, V_{FB} is regulated at V_{REF} . The output voltage is determined in Equation (1):

$$V_O = V_{ref} \frac{R_{up} + R_{low}}{R_{low}} \tag{1}$$

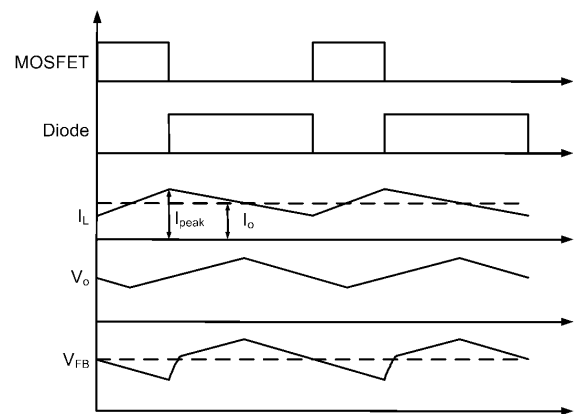

Figure 3: Constant Voltage Regulation

An internal resistor divider connected to VCC and FB provides a fixed output feedback. The lower resistor of the internal feedback divider is 450k Ω , typically.

To achieve an adjustable output, an external feedback divider with a much smaller resistance should be connected to FB so that the internal feedback is overridden.

A VCC capacitor is used for sampling and holding the output voltage in addition to supplying the IC operation.

Frequency and Peak Current Foldback

Due to the constant voltage regulation scheme adopted by the MP161, its switching frequency decreases as the load reduces. The MP161 peak current folds back along with the switching frequency. As a result, the MP161 is able to achieve excellent overall efficiency. The switching frequency for continuous conduction mode (CCM) can be calculated with Equation (2):

$$f_s = \frac{(V_{in} - V_o) \cdot V_o}{2L(I_{peak} - I_o) \cdot V_{in}} \quad (2)$$

The switching frequency for discontinuous conduction mode (DCM) can be calculated with Equation (3):

$$f_s = \frac{2(V_{in} - V_o) \cdot I_o \cdot V_o}{L I_{peak}^2 \cdot V_{in}} \quad (3)$$

When the switching frequency drops into the audible frequency range under very light-load condition, the peak current folds back to its minimal value to minimize the audible noise.

Leading-Edge Blanking

An internal leading-edge blanking (LEB) unit prevents premature switching pulse termination due to a turn-on spike. The spike is mainly caused by parasitic capacitance and reverse recovery of the freewheeling diode (under CCM).

Protections for the Switching Regulator

Whenever a protection condition is triggered, the IC stops switching, the internal HV current source is disabled, and the VCC capacitor is discharged by I_{CCL} . The internal HV current source is not enabled again until VCC drops below V_{CCpro} .

The MP161 includes four types of protection.

1. **Overload Protection (OLP):** The maximum output power of the switching regulator is limited by the maximum switching frequency and peak current limit. If the load exceeds the power limit, the output voltage is not able to stay in regulation. OLP is triggered when the MOSFET off time is at the t_{offmin} limitation (which indicates that the switching frequency has reached the maximum) for

8192 consecutive cycles. The validation time for OLP is able to prevent tripping during start-up and transient periods.

2. **Short-Circuit Protection (SCP):** If the current flowing through the internal MOSFET after LEB2 is higher than the SCP threshold, SCP is triggered immediately. SCP is disabled during soft start.
3. **Over-Temperature Protection (OTP):** To prevent any thermal-induced damage, the MP161 is shut down when the junction temperature exceeds the thermal shutdown threshold. There is also a hysteresis implemented for OTP, so the chip does not recover until the junction temperature drop exceeds the thermal shutdown recovery hysteresis.
4. **Brown-Out Protection (BOP):** If the turn-on time hits the maximum limitation for four consecutive cycles, BOP is triggered.

Low-Dropout Linear Regulator (LDO)

The MP161 integrates a low-dropout linear regulator (LDO). Usually, the LDO input (VIN) is connected to the output of the switching regulator. VIN can adapt to any input voltage below V_{OVP} . The output voltage of the LDO is internally fixed with two options for fixed voltage outputs (5V and 3.3V).

The LDO itself also implements OTP, which is independent from the switching regulator. However, the protection scheme is similar to the switching regulator's scheme.

Relay Drivers

The MP161 integrates two channels of relay drivers, which are compatible to 3.3 - 5V COMS logic and TTL logic interface.

A low-impedance MOSFET is used to drive the relay (see Figure 4). There is also an integrated freewheeling diode to take over the relay coil current when the MOSFET turns off. An R-C filter is implemented internally for each channel to improve noise immunity. The drivers also feature an internal pull-down resistor to allow for tri-state input and normal off operation.

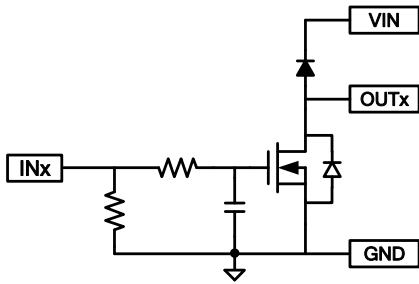

Figure 4: Block Diagram of Internal Relay Driver

OVP on VIN

A propriety OVP feature is implemented in the MP161. When the voltage on VIN exceeds V_{OVP} , the switching regulator is shut down to stop energy from flowing to the output any further. There is also an internal current pulled from VIN to help discharge the external capacitor when OVP is triggered. This protection feature can prevent damage on critical loads from over-stress when VIN regulation fails.

Standby Mode Operation

The MP161 can switch between normal operation mode and standby mode according to the input on STBY. When STBY is low, the MP161 works in normal mode, and the output voltage of the switching regulator is regulated based on $V_{CC_{REF}}$ (fixed output) or V_{REF} (adjustable output). When STBY is high, the chip works in standby mode, and the switching regulator output is regulated at $V_{CC_{STBY}}$.

Standby mode is used to save power by reducing the switching regulator output voltage when the load on this output rail is idle.

When entering standby mode, the VCC regulating voltage drops step-by-step to keep the output properly regulated. There is also a soft-start procedure when exiting standby mode.

APPLICATION INFORMATION

Selecting the Input Capacitor

The input capacitor supplies DC input voltage to the converter. Figure 5 shows the typical DC bus voltage waveform of the half-wave rectifier and full-wave rectifier.

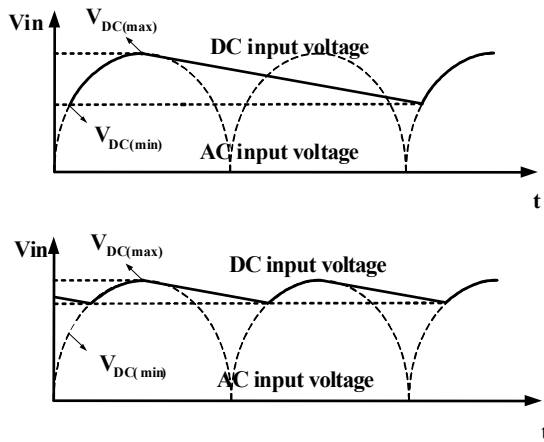

Figure 5: Input Voltage Waveform

Typically, the use of a half-wave rectifier requires an input capacitor rated at $3\mu\text{F}/\text{W}$ for the universal input condition. When using a full-wave rectifier, the input capacitor is rated at $1.5 \sim 2\mu\text{F}/\text{W}$ for the universal input condition. The half-wave rectifier is recommended for $<2\text{W}$ output applications. The full-wave rectifier is recommended for $>2\text{W}$ output applications.

Avoid using an input capacitor that is too small, since it may not be able to hold the DC voltage high enough. A low DC input voltage can lead to bad thermal performance. If the input voltage is very low, the MOSFET on time may reach T_{maxon} , triggering brown-out protection.

Selecting the Inductor

The MP161 has a minimum off-time limit that determines the maximum output power. The maximum power increases as the inductor increases. Using a very small inductor may cause not enough output power, but a larger inductor leads to an inappropriate OLP point. Select an inductor with a minimum value that can meet the overload requirement. The tolerance of the peak-current limit and minimum off time should also be considered for mass production.

Estimate the OLP point for CCM with Equation (4):

$$P_{\text{o,max}} = V_o \left(I_{\text{Limit}} - \frac{V_o \tau_{\text{minoff}}}{2L} \right) \quad (4)$$

Estimate the OLP point for DCM with Equation (5):

$$P_{\text{o,max}} = \frac{1}{2} L I_{\text{Limit}}^2 \frac{1}{\tau_{\text{minoff}}} \quad (5)$$

To reduce costs, use a standard off-the-shelf inductor no less than the calculated value.

Selecting the Freewheeling Diode

The diode should be selected based on the maximum input voltage and peak current.

The freewheeling diode's reverse recovery can affect efficiency and circuit operation for CCM. Use an ultra-fast reverse recovery diode, such as the UGC10JH.

Selecting the Output Capacitor

An output capacitor is required to maintain the DC output voltage. Estimate the output voltage ripple for CCM with Equation (6):

$$V_{\text{OUT_ripple}} = \frac{\Delta i}{8f_s C_o} + \Delta i R_{\text{ESR}} \quad (6)$$

Estimate the output voltage ripple for DCM with Equation (7):

$$V_{\text{OUT_ripple}} = \frac{I_o}{f_s C_o} \left(\frac{I_{\text{pk}} - I_o}{I_{\text{pk}}} \right)^2 + I_{\text{pk}} R_{\text{ESR}} \quad (7)$$

Low ESR electrolytic or ceramic capacitors are recommended to reduce the output voltage ripple if necessary.

External Feedback Resistors

For adjustable output configurations, the total external resistance should not exceed $100\text{k}\Omega$ to override the internal feedback resistor divider. The external resistor value can also be adjusted to meet the output voltage target if large external resistors are preferred.

Feedback Capacitor

The feedback capacitor provides a sample-and-hold function. For both fixed and adjustable output setups, VCC is used as the feedback capacitor. A 1µF VCC capacitor is recommended, typically, but the optimized VCC capacitor may vary in different applications. A large VCC capacitor is preferred since it results in small no-load consumption and good light-load regulation, and also helps increase the hiccup duration during protections. However, stability may be affected when the feedback capacitor is too large.

Dummy Load

A dummy load is required to maintain the switching regulator output voltage under no-load condition. The switching regulator delivers a certain amount of power under no-load condition due to a minimum switching frequency determined by the feedback R-C discharge rate. This power is dissipated by the dummy load so that output voltage does not run away.

A large dummy load current leads to better regulation but larger no-load consumption. The current is a compromise between small no-load consumption and good no-load regulation. Typically, a resistor is used as a dummy load. In Figure 7, the dummy load resistor is not used because there is already ~250µA of consumption current on VIN, which can act as a dummy load.

Surge Performance

The input capacitor can also be used for surge suppression. There is no need to use other surge suppression components if an appropriate input capacitor value is chosen. Figure 6 shows the typical half-wave rectifier used in low-power offline applications. Table 1 shows the capacitance required under normal conditions for different surge levels. FR1 is a 20Ω/2W fused resistor, and L1 is 1mH for this recommendation.

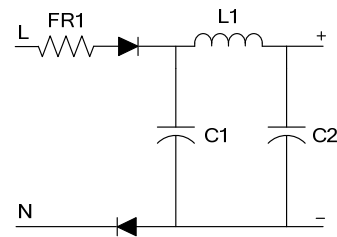

Figure 6: Half-Wave Rectifier

Table 1: Recommended Capacitance

Surge Voltage	500V	1000V	2000V
C1	1µF	2.2µF	3.3µF
C2	1µF	2.2µF	3.3µF

Input and Output Capacitors of LDO

Place an input ceramic capacitor (1 - 10µF) between VIN and GND. A larger value in this range improves the line transient response.

Place an output ceramic capacitor (1 - 10µF) between VO and GND. A larger value in this range improves load transient response.

Relay

The coil of relay is connected between VIN and VOUTx.

PCB Layout Guidelines

Efficient PCB layout is critical for stable operation, good EMI, and good thermal performance. For best results, follow the guidelines below.

- 1) Minimize the loop area formed by the input capacitor, 700V switching regulator, freewheeling diode, inductor, and output capacitor.
- 2) Place the power inductor far away from the input filter while keeping the loop area to a minimum.
- 3) Place a bypass capacitor around 47pF between FB and SOURCE as close to the IC as possible.
- 4) Connect a large copper area to GND for better LDO thermal performance.

Design Example

Table 2 shows a design example for the following application guideline specifications.

Table 2: Design Example

V_{IN}	85V _{AC} to 265V _{AC}
V_{OUT1}	12V
I_{OUT1}	70mA
V_{OUT2}	5V
I_{OUT2}	50mA

The detailed application schematic is shown in Figure 7. The typical performance and circuit waveforms are shown in the Typical Performance Characteristics section. For additional device applications, please refer to the related evaluation board datasheet.

TYPICAL APPLICATION CIRCUIT

Figure 7 shows a typical application example of a 12V/70mA and 5V/50mA non-isolated power supply using the MP161AGS-5.

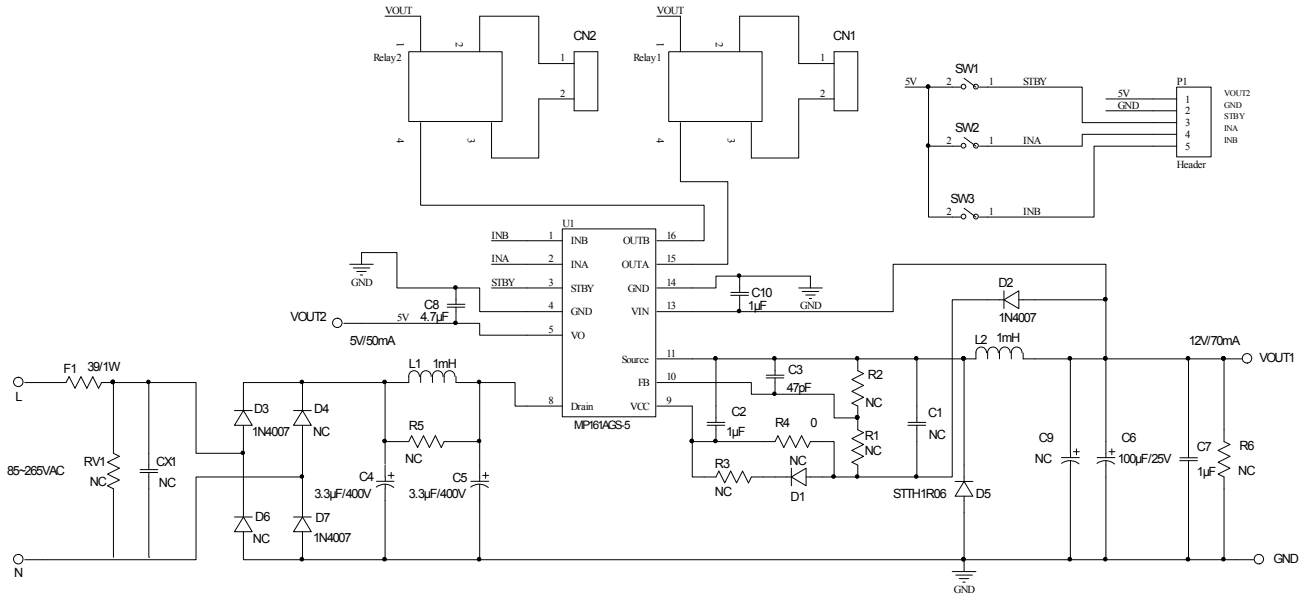

Figure 7: Typical Application with 12V/70mA, and 5V/50mA Output

FLOW CHART

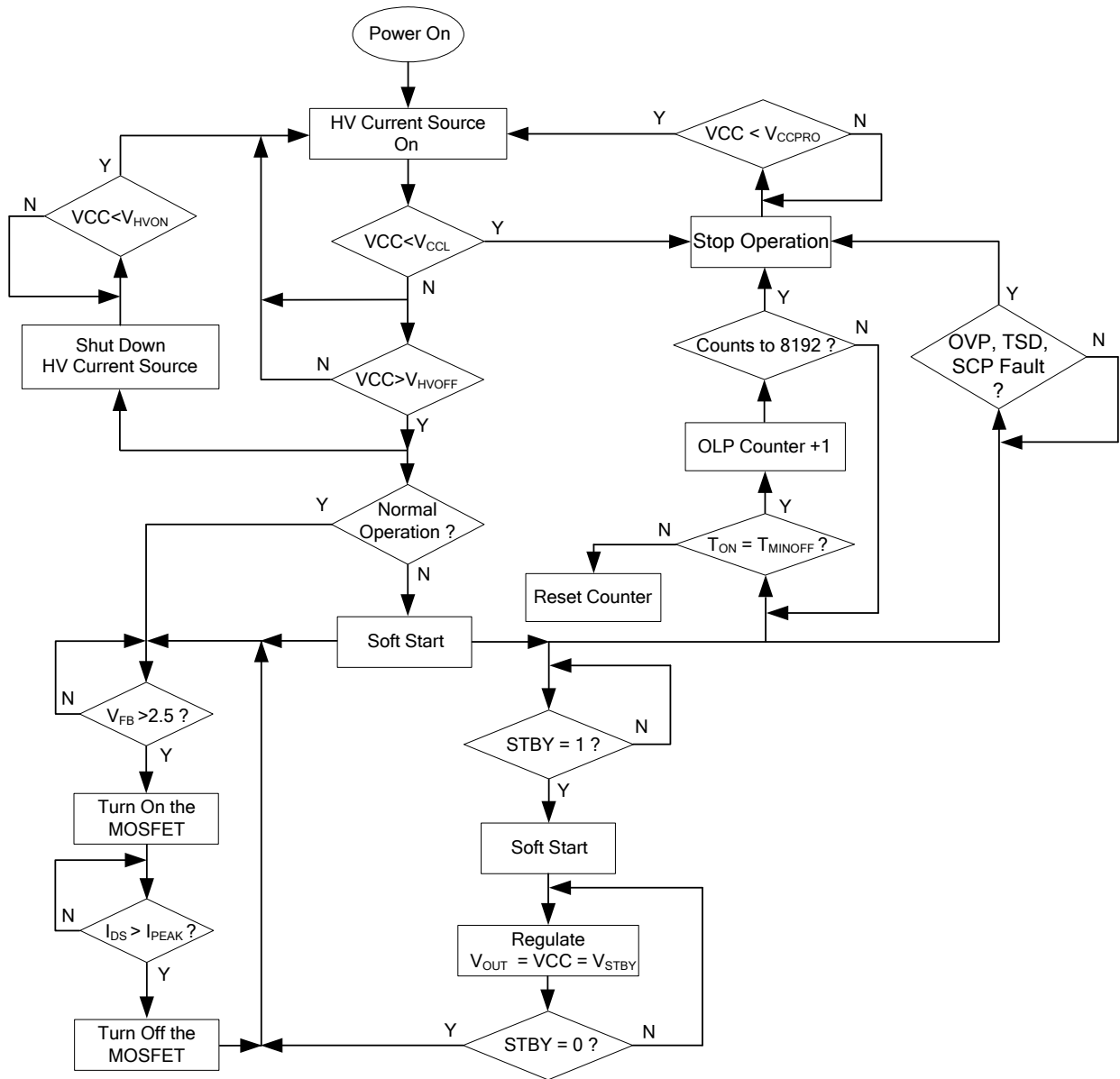

Figure 8: Control Flow Chart

SIGNAL SEQUENCE

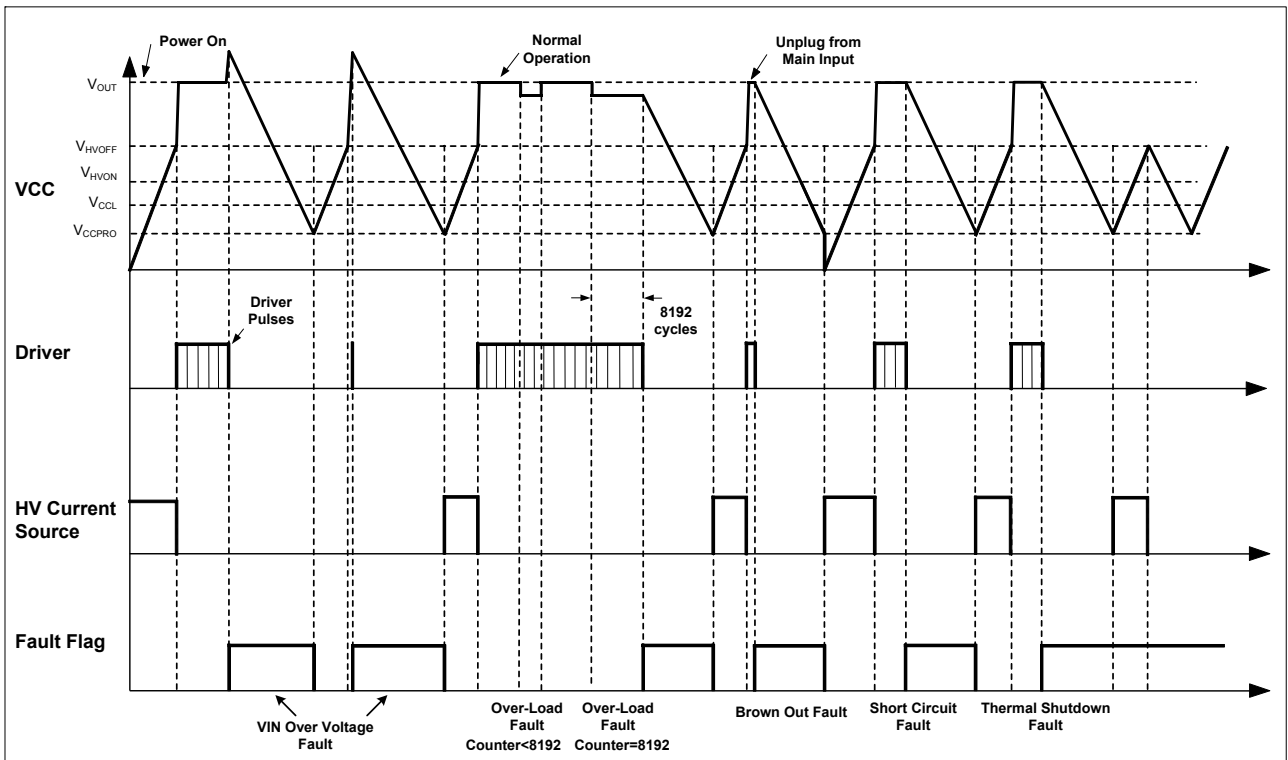
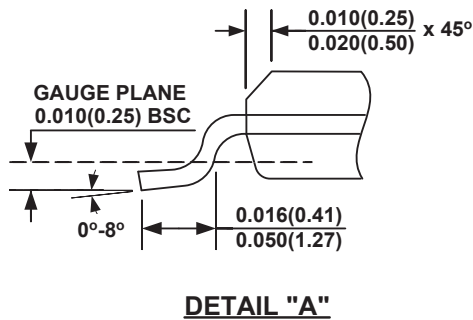
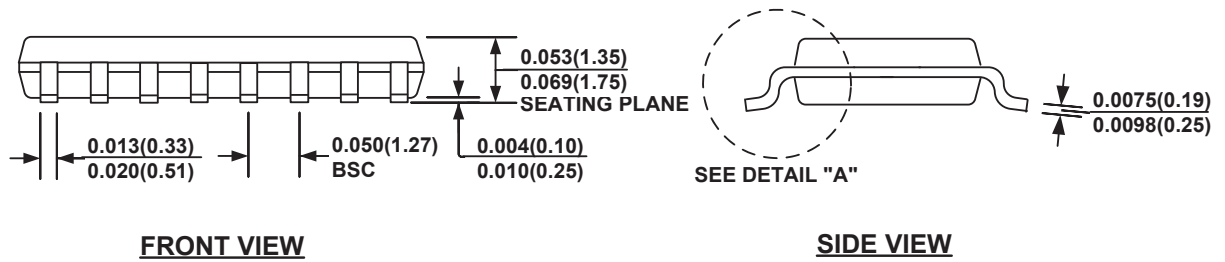
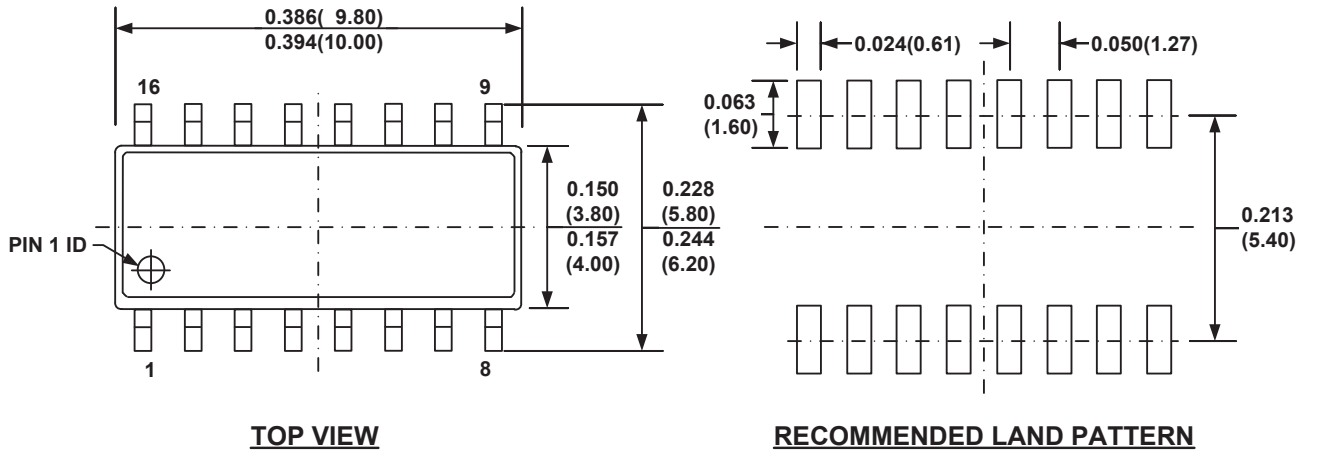

Figure 9: Signal Evolution in the Presence of a Fault

PACKAGE INFORMATION

SOIC-16



NOTE:

- 1) CONTROL DIMENSION IS IN INCHES. DIMENSION IN BRACKET IS IN MILLIMETERS.
- 2) PACKAGE LENGTH DOES NOT INCLUDE MOLD FLASH, PROTRUSIONS OR GATE BURRS.
- 3) PACKAGE WIDTH DOES NOT INCLUDE INTERLEAD FLASH OR PROTRUSIONS.
- 4) LEAD COPLANARITY (BOTTOM OF LEADS AFTER FORMING) SHALL BE 0.004" INCHES MAX.
- 5) DRAWING CONFORMS TO JEDEC MS-012, VARIATION AC.
- 6) DRAWING IS NOT TO SCALE.

NOTICE: The information in this document is subject to change without notice. Please contact MPS for current specifications. Users should warrant and guarantee that third party Intellectual Property rights are not infringed upon when integrating MPS products into any application. MPS will not assume any legal responsibility for any said applications.