

NOTES: VALID UNLESS OTHERWISE SPECIFIED

1. GENERAL:
 - a. APPLICATION SPECIFICATION: AS-31386-200
 - b. PRODUCT SPECIFICATION: PS-31387-200
 - c. PACKAGING SPECIFICATION: PK-31301-916
 - d. PARTS MUST BE IN COMPLIANCE TO MOLEX CHEMICAL SUBSTANCES FOR PRODUCTS AND PACKAGING SPECIFICATION: ES-40000-5016
 - e. DATA MUST BE SUBMITTED UNDER THE MOLEX PART NUMBER TO IMDS (COMPANY ID#13255)
 - f. DIMENSIONS AND TOLERANCES ARE VALID FOR AS SHIPPED SHROUD ASSEMBLY
 - g. REFERENCE GM INTERFACE CONTROL DRAWINGS (ICD)
 1. 12582682 (Au)
 2. 12642695 (Ag)
2. DESIGN - MATERIALS
 - a. PLASTIC: PBT 30% GF - SEE CHART FOR COLOR
 - b. SIGNAL PIN PLATING:
 - UNDERPLATE: NICKEL 1.27-2.54 μ m
 - SELECT GOLD OPTION: 0.76 μ m MIN.
 - SELECT SILVER OPTION: 1.90-3.30 μ m MIN
 - SOLDER TAIL SELECT TIN: 5.08-10.16 μ m BRIGHT FINISH
 - c. GROUND PIN PLATING:
 - UNDERPLATE: NICKEL 1.27-2.54 μ m
 - OVERPLATE: SELECT TIN 2.54-4.06 μ m, MATTE FINISH
3. DESIGN - GEOMETRY:
 - a. THIS IS A 100% CAD GENERATED PART. THE CAD MATHEMATICAL DATA IS THE MASTER FOR ALL NON-DIMENSIONAL FEATURES. DRAWING DIMENSIONS SHALL BE MET WHEN DIFFERENCES EXIST BETWEEN THE DRAWING AND THE CAD MODEL. UNDERLINED DIMENSIONS OR DIMENSIONS INDICATED AS 'EDITED' MAY BE DIFFERENT FROM THE 3D MODEL GEOMETRY. FOR DIMENSIONAL OR ANY INFORMATION NOT SHOWN ON THIS DRAWING, ANALYZE THE CAD MODEL.
 - b. PRODUCT DESIGN MODEL NUMBER(S): SEE BOM TABLE
 - c. GEOMETRIC DIMENSIONS AND TOLERANCES PER ASME Y14.5M-1994
 - d. GENERAL TOLERANCES - SEE TABLE
4. DESIGN - MANUFACTURING:
 - a. HUMAN READABLE LASER MARKING
 1. INFORMATION TO BE PRINTED:
 - DDY - 4 DIGIT JULIAN DATE CODE
 - S_HH - STITCHER NUMBER_HOUR NUMBER (24 HOUR CLOCK)
 - MMMM - LAST FOUR DIGITS OF MOLEX MATERIAL NUMBER
 2. SIZE: HUMAN LEGIBLE
 - b. PIN MATE SIDE AND PCB SIDE TRUE POSITION TO BE VERIFIED ONLINE WITH A GO/NO-GO FUNCTIONAL GAGE.
 - c. ANTI-TARNISH FOR Ag PLATING ONLY; SYNTHETIC HYDROCARBON CONTACT SURFACE FINISH OR EQUIVALENT APPLIED WITHOUT VOID TO CONTACT AREA (MIN. 3.7mm FROM PIN TIP).
 - d. VISUAL DEFECTS SHALL MEET COSMETIC STANDARD PS-45499-002 (CLASS B)
 - e. THERE SHALL BE NO PERMISSIBLE DEFECTS THAT COULD POTENTIALLY PROHIBIT THE FUNCTIONALITY WITHIN THE SEALING SURFACE/ZONE SUCH AS PARTING LINES, MISMATCHES, SINK, TEXTURE VARIATIONS, SCRATCHES/GOUGES, SHORT FILL, PROTRUSIONS, PITS, DENTS/NICKS, BLISTERS OR EJECTOR MARKS.

A8	UPDATE STATUS TO SALEABLE
A7	UPDATED NOTE 1c SAP# 10595870
A6	ADDED NOTE 4d, e & SEALING ZONE ON PG 2 SAP# 10586362
A5	MODIFIED HIGH RETENTION CAVITY FOR 2.8 GROUND PIN SAP# 10584227
A4	ADDED BALLOONS 1,2,6-15,19,20,24-47 REMOVED BALLOONS 3-5,17,18,21-23 EDITED ALL NOTES, STATUS & MATING HARNESS PART NUMBER SAP# 10580347
REV	DESCRIPTION

INSPECTION BALLOON NUMBER LOG			
PER DRAWING REVISION: A6			
LAST BALLOON NUMBER: 47			
ADDED INSPECTION NUMBER: 1 2 6 7 8 9 10 11 12 13 14 15 19 20 24 25 26 27 28 29 30 31 32			
33 34 35 36 37 38 39 40 41 42 43 44 45 46 47			
DELETED INSPECTION BALLOON NUMBER: 3 4 5 16 17 18 21 22 23			
SEE REV COLUMN	QUALITY SYMBOLS	GENERAL TOLERANCES (UNLESS SPECIFIED)	DIMENSION STYLE
LEC NO: UAU2014-0926	▽=0	4 PLACES ± .05	MM ONLY
DRWNSBARRY	▽=0	3 PLACES ± .03	DRAWN BY DATE
CHKD: APPR:DKRAMCZYK	▽=0	2 PLACES ± 0.13	HKASSAB 2011/02/09
2013/12/06		1 PLACE ± 0.25	CHECKED BY DATE
		0 PLACE ±	
		ANGULAR ± 3°	APPROVED BY DATE
		DRAFT WHERE APPLICABLE MUST REMAIN WITHIN DIMENSIONS	RBAUMAN 2011/02/16
A8			MATERIAL NO. DOCUMENT NO.
			SCALE 2:1 DESIGN UNITS METRIC
			THIRD ANGLE PROJECTION
			TITLE 66 CKT SHROUD ASSY GENERAL MAKRET
			molex
			SIZE D THIS DRAWING CONTAINS INFORMATION THAT IS PROPRIETARY TO MOLEX INCORPORATED AND SHOULD NOT BE USED WITHOUT WRITTEN PERMISSION
			SHEET NO. 1 OF 3

SHROUD ASSEMBLY NUMBER	MATE SIDE PIN FINISH	COLOR	HARNESS SIDE KEY CODE	PCB SIDE KEY LOCATION		MATING HARNESS PART NUMBER (OPT 0, OPT 9)	STATUS
				DIM. "A"±0.30	DIM. "B"±0.30		
31387-8001	GOLD	BLACK	A	8.89	29.21	34822001B 348220023	SALEABLE
31387-8003	GOLD	BLUE	C	8.89	34.29	34822003B 348220043	SALEABLE
31387-8004	SILVER	BLACK	A	8.89	29.21	34822001B 348220023	SALEABLE
31387-8006	SILVER	BLUE	C	8.89	34.29	34822003B 348220043	SALEABLE

SHROUD ASSEMBLY
TRACEABILITY INFORMATION
FOR MOLEX INTERNAL USE ONLY
(SEE NOTE 4d)

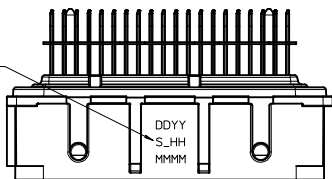

MATE SIDE
POLARIZATION KEY
AT CORNERS

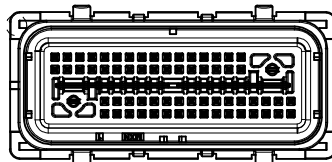

KEY OPTION "A"

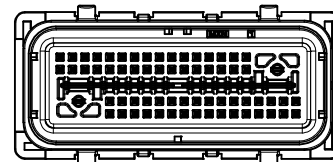
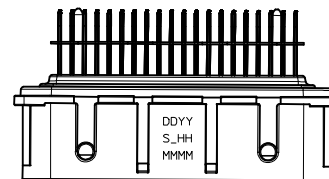

KEY OPTION "C"

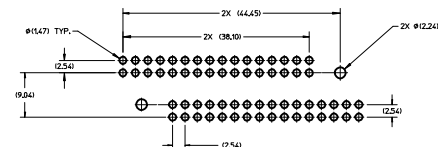

PCB LAYOUT FOR REFERENCE ONLY

SEE SHEET 1 SEC NO: UAU2014-0926 DRWNSRABBY 2013/12/06 CHKD: APPR:IKRAMZYK 2013/12/06 REV:	QUALITY SYMBOLS	GENERAL TOLERANCES (UNLESS SPECIFIED)	DIMENSION STYLE	SCALE	DESIGN UNITS	THIRD ANGLE PROJECTION
	$\nabla=0$ $\nabla=0$ $\nabla=0$	4 PLACES ± --- INCH 3 PLACES ± --- INCH 2 PLACES ± 0.13 INCH 1 PLACE ± 0.25 INCH 0 PLACE ± INCH	mm INCH ANGULAR ± 3 ° DRAFT WHERE APPLICABLE MUST REMAIN WITHIN DIMENSIONS	MM ONLY DRAWN BY: HKASSAB DATE: 2011/02/09 CHECKED BY: DATE APPROVED BY: RBAUMAN DATE: 2011/02/16	2:1	METRIC
A8			MATERIAL NO. SEE CHART		DOCUMENT NO. SD-31387-066	SHEET NO. 3 OF 3

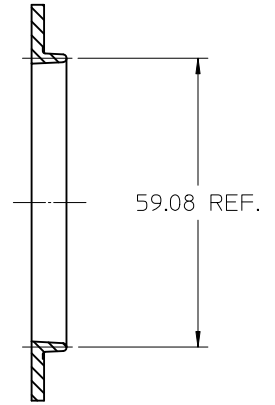
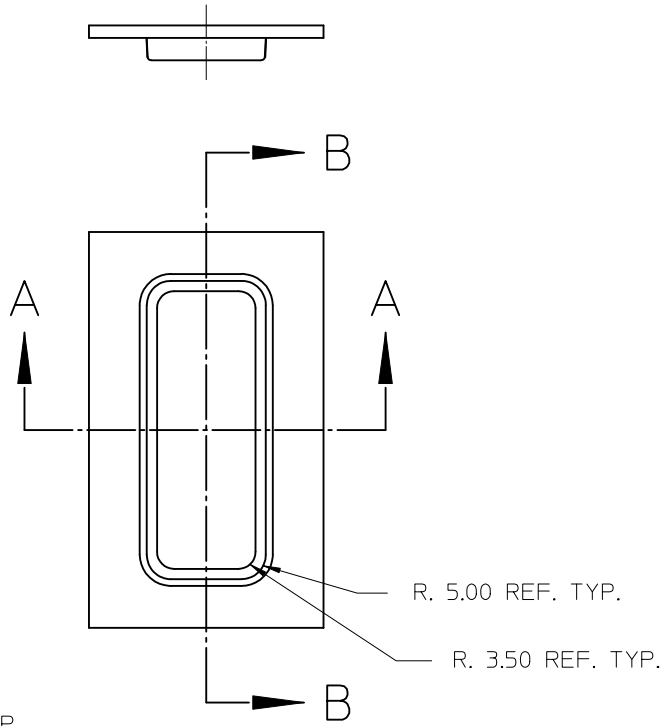
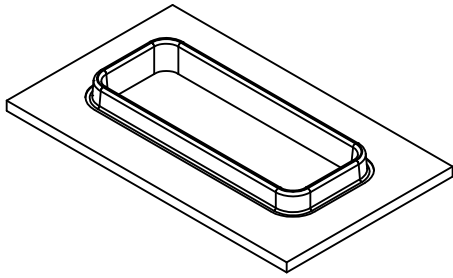

SECTION B-B

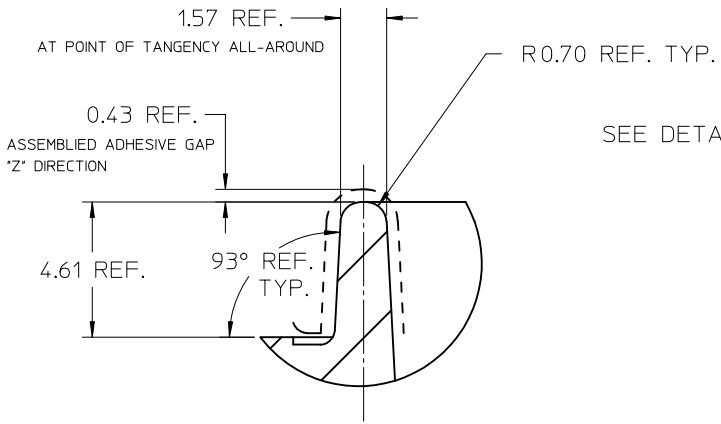

DETAIL 6:1

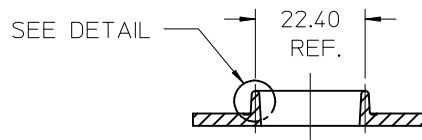

SECTION A-A

ENTER DESCRIPTION EC NO: UAU2012-1624 DRAWN BY: DRW:DDUNN 2013/01/30 CHKD: JOUNAJ 2013/02/07 APPR: DKRAWCZYK 2013/02/19 REV B	QUALITY SYMBOLS ▽=0 ▽=0	GENERAL TOLERANCES (UNLESS SPECIFIED)		DIMENSION STYLE MM ONLY		SCALE 1:1	DESIGN UNITS METRIC	THIRD ANGLE PROJECTION	
		mm	INCH	DRAWN BY	DATE	TITLE			
	4 PLACES	±---	±---	F JAKLIC	11/21/2008	LARGE FOOTPRINT ADHESIVE TONGUE GEOMETRY			
	3 PLACES	±---	±---	CHECKED BY	DATE				
2 PLACES	±---	±---	G PRATT	11/21/2008	MOLEX INCORPORATED				
1 PLACE	±---	±---	APPROVED BY	DATE					
	ANGULAR ±---°		DKRAWCZYK	2013/02/19	DOCUMENT NO.		SD-31387-173		SHEET NO.
DRAFT WHERE APPLICABLE MUST REMAIN WITHIN DIMENSIONS			SIZE B	THIS DRAWING CONTAINS INFORMATION THAT IS PROPRIETARY TO MOLEX INCORPORATED AND SHOULD NOT BE USED WITHOUT WRITTEN PERMISSION					1 OF 1