

MATERIALS AND FINISHES

SMB JACK FAKRA FOR 1.32 CABLE

BODY, REAR BODY BRASS  
PLATED NICKEL

HOUSING BRASS  
PLATED TIN

CENTER CONTACT BRASS  
PLATED GOLD

INSULATOR TEFLON

OUTER CASTING HIGH TEMPERATURE PLASTIC  
KEYING CODE C  
COLOR BLUE

MCRF W/1.32 CABLE

BODY, PHOSPHOR BRONZE  
PLATED GOLD

CENTER CONTACT, PHOSPHOR BRONZE  
PLATED GOLD

INSULATOR, PBT  
CABLE, 1.32 CABLE

PACKAGING BY POLYBAG

SPECIFICATION:

1. FREQUENCY RANGE: 0-6 GHz
2. IMPEDANCE: 50OHMS
3. VSWR: 1.6 MAX.
4. INSERTION LOSS: <-1.0dB

PART # 89762-7950

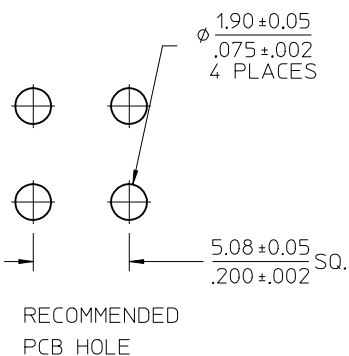
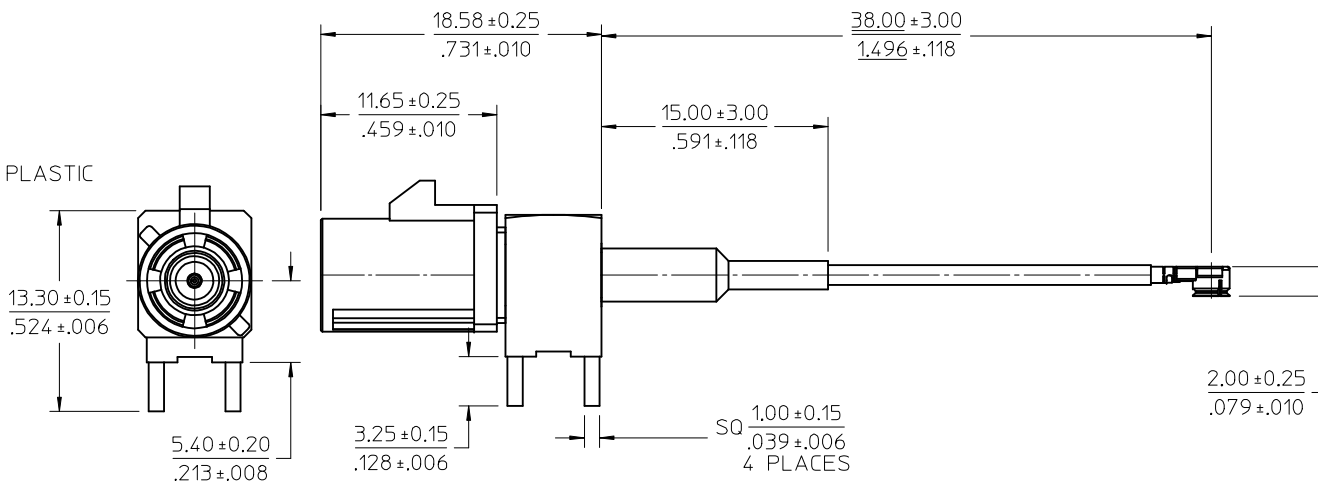
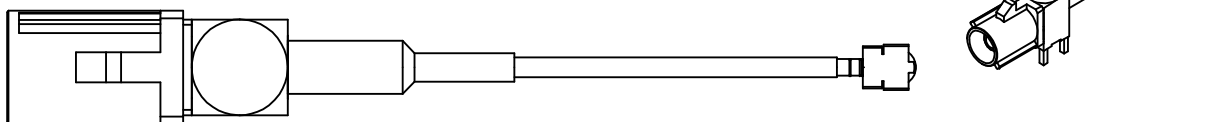

DESIGN CHANGE  
CABLE LENGTH AND  
HOUSING LEG  
PER RF16-E039  
EC NO: URF2016-0626  
DRAWN:LIN 2016/03/11  
CHKD:  
APPR:YCHENG 2016/04/27

REV	DESCRIPTION
1	QUALITY SYMBOLS
2	▽=0
3	▽=0

GENERAL TOLERANCES (UNLESS SPECIFIED)	
mm	INCH
4 PLACES ± .---	± .---
3 PLACES ± .---	± .---
2 PLACES ± .---	± .---
1 PLACE ± .---	± .---
ANGULAR ± 2 °	
DRAFT WHERE APPLICABLE MUST REMAIN WITHIN DIMENSIONS	

DIMENSION STYLE	
MM/IN	
DRAWN BY	DATE
EL IN	2015/09/01
CHECKED BY	DATE
JOANNE	2015/09/01
APPROVED BY	DATE
YCHENG	2015/12/15

SCALE	DESIGN UNITS	THIRD ANGLE PROJECTION
	METRIC	
TITLE		
CA SMB JACK FAKRA TO MCRF W/1.32 CABLE CA-FAKRA-J/MCRF		
MATERIAL NO.		SHEET NO.
897627950		1 OF 2
DOCUMENT NO.		
SD-89762-795		
THIS DRAWING CONTAINS INFORMATION THAT IS PROPRIETARY TO MOLEX INCORPORATED AND SHOULD NOT BE USED WITHOUT WRITTEN PERMISSION		

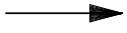
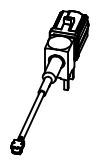

P/N: 89762-7950

25 SET PER BAG  
BAG P/N: 89707-0001

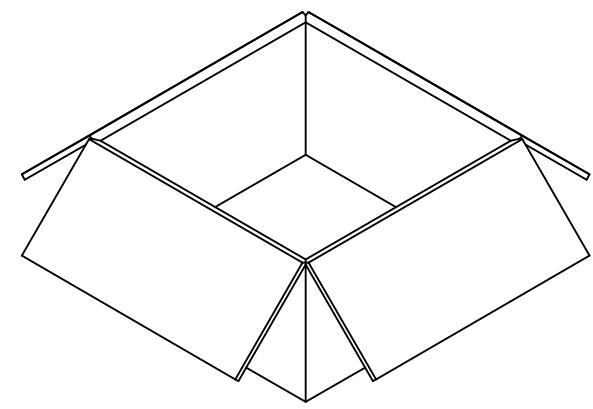
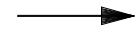
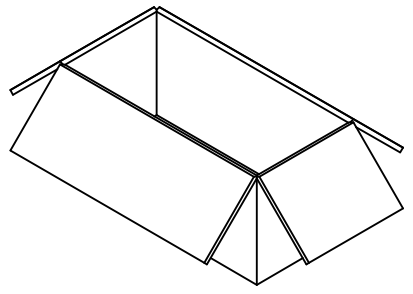

500 SET PER INNER  
CARTON BOX  
P/N: 96707-0001  
367mm\*173mm\*188mm

1000 SET PER OUTER  
CARTON BOX  
P/N: 96708-0005  
385mm\*367mm\*206mm

SEE SHEET 1 EC NO: URF2016-0626 2016/03/11 DRWINEL IN CHKD: APPR: YCHENG 2016/04/27 DESCRIPTION	QUALITY SYMBOLS	GENERAL TOLERANCES (UNLESS SPECIFIED)	DIMENSION STYLE	SCALE	DESIGN UNITS	THIRD ANGLE PROJECTION
	▽=0	mm INCH	MM/IN	1:5	METRIC	☉
	▽=0	4 PLACES ± --- ± ---	DRAWN BY DATE	TITLE	DOCUMENT NO.	SHEET NO.
	▽=0	3 PLACES ± --- ± ---	EL IN 2015/09/01			
	2 PLACES ± --- ± ---	CHECKED BY DATE	CA SMB JACK FAKRA TO MCRF W/1.32 CABLE CA-FAKRA-J/MCRF			
	1 PLACE ± --- ± ---	APPROVED BY DATE	molex SD-89762-795 2 OF 2			
	0 PLACE ± --- ± ---	YCHENG 2015/12/15				
	ANGULAR ± 2 °	DRAFT WHERE APPLICABLE MUST REMAIN WITHIN DIMENSIONS	SEE SHEET 1			
			SIZE C	THIS DRAWING CONTAINS INFORMATION THAT IS PROPRIETARY TO MOLEX INCORPORATED AND SHOULD NOT BE USED WITHOUT WRITTEN PERMISSION		