

NOTE
 1. 嵌合相手: 51382-****
 2. 偶数極(列)に適用。
 3. キングは両外側の位置に付加。
 4. 製品番号 MATERIAL NO.
55935-****
 極数 CIRCUIT SIZE

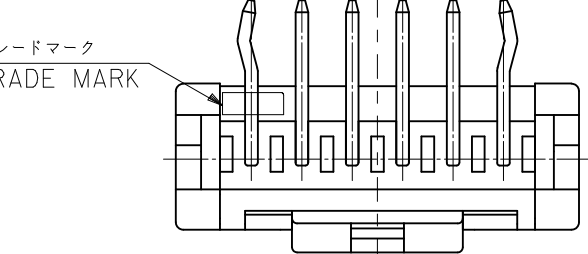
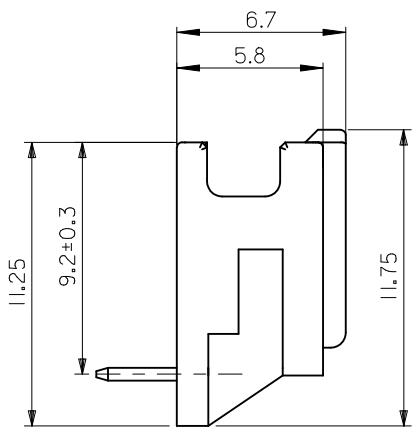
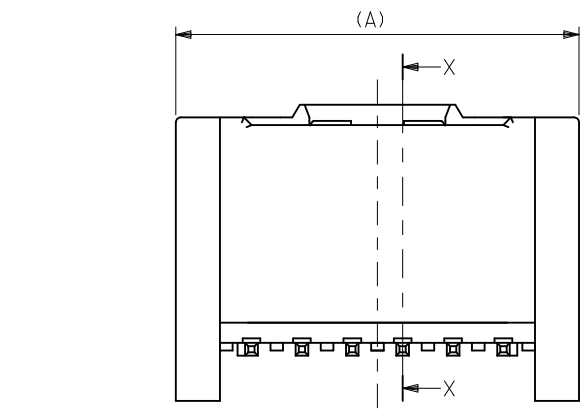
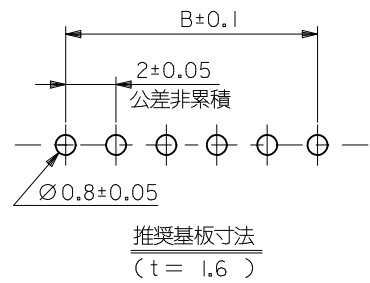

色 COLOR

30	自然色(白) NATURAL(WHITE)
31	黒 BLACK
32	赤 RED
33	黄 YELLOW
34	青 BLUE
35	桃 PINK
36	緑 GREEN
37	茶 BROWN
38	橙 ORANGE
39	紫 VIOLET
51	灰 GRAY
53	蛍光黄 FLUORESCENT YELLOW
54	水 PALE BLUE
55	蛍光桃 FLUORESCENT PINK
56	黄緑 YELLOWISH GREEN
58	蛍光橙 FLUORESCENT ORANGE

6. キャビティ番号 : 1~2桁の数字
 金型番号 : アルファベット1文字にて構成
 (例 1A, 10B)
 尚、金型番号は刻印無しの製品あり。
 FORMED BY 1 DIGIT TO " DIGIT
 NUMBERS (TO CAVITY No.)
 AND BY 1 LETTER OF ALPHABET.
 (TO MOLD No.)
 (e.g. 1A,10B)
 THERE ARE PRODUCTS WITHOUT
 THE MARK OF MOLD No.

31	28	34	55935-15**	15
29	26	32	55935-14**	14
27	24	30	55935-13**	13
25	22	28	55935-12**	12
23	20	26	55935-11**	11
21	18	24	55935-10**	10
19	16	22	55935-09**	9
17	14	20	55935-08**	8
15	12	18	55935-07**	7
13	10	16	55935-06**	6
11	8	14	55935-05**	5
9	6	12	55935-04**	4
7	4	10	55935-03**	3
5	2	8	55935-02**	2
C	B	A	MATERIAL NO.	CKT.

5. トレードマーク: Mプラス1~2文字のアルファベットにて構成。(例: MXJ)
 但し、"J"はJAPANを示す。
 FORMED BY M AND 1-2 MORE LETTER OF ALPHABET (e.g. MXJ) TO TRADE MARK. BUT "J" SHOW JAPAN.

MATERIAL
 ピン : 黄銅、ニッケル下地錫メッキ
 ハウジング : PBT

REVISED EC NO.: J2010-2139 DRWN: THANU 2010/04/26 CHKDK: ASAKAWA 2010/04/26 APPR: NUKITA 2010/04/27 K	DESCRIPTION REV	GENERAL TOLERANCES (UNLESS SPECIFIED)		DIMENSION STYLE MM ONLY		SCALE ---	DESIGN UNITS METRIC	THIRD ANGLE PROJECTION		
		10 UNDER	±0.2	DRAWN BY T. NIITSU	DATE '02/02/08	TITLE 2.0 W/B SINGLE CONN. PLUG HOUSING ASS'Y R/A -LEAD FREE-				
		10 OVER 30 UNDER	±0.25	CHECKED BY K. ASAKAWA	DATE '03/06/12	MOLEX INCORPORATED				
		30 OVER	±0.3	APPROVED BY T. YAMAGUCHI	DATE '03/06/12	DOCUMENT NO. SD-55935-002				
		ANGULAR ±3 °	DRAFT WHERE APPLICABLE MUST REMAIN WITHIN DIMENSIONS		MATERIAL NO. SEE CHART		SHEET NO. 1 OF 2			
THIS DRAWING CONTAINS INFORMATION THAT IS PROPRIETARY TO MOLEX INCORPORATED AND SHOULD NOT BE USED WITHOUT WRITTEN PERMISSION										

10 9 8 7 6 5 4 3 2 1

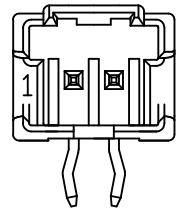
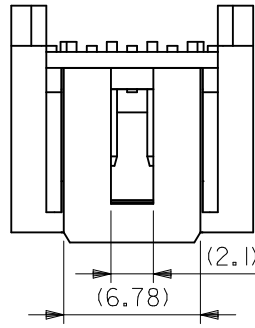
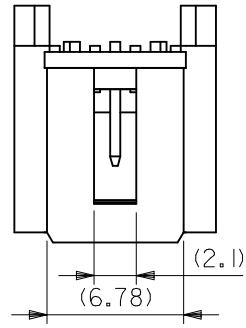
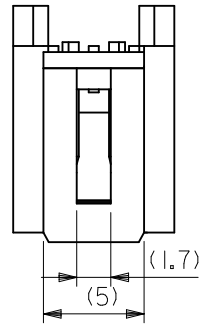

2 CIRCUIT

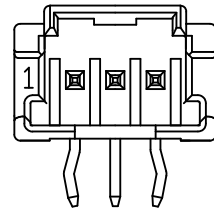

3 CIRCUIT

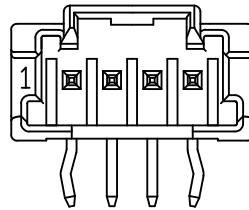

4 CIRCUIT 以上

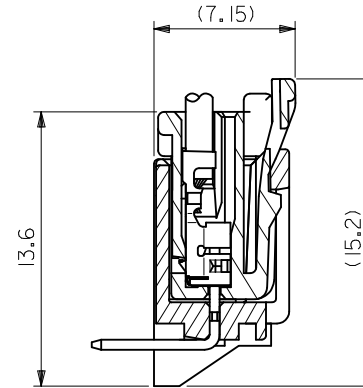

嵌合断面图

MODEL NO. : 55935-****

REVISED EC NO: J2010-2139 DRWN: THANU 2010/04/26 CHK'D: ASAKAWA 2010/04/26 APPR: NUKITA 2010/04/27 K	DESCRIPTION REV	GENERAL TOLERANCES (UNLESS SPECIFIED)		DIMENSION STYLE MM ONLY		SCALE ---	DESIGN UNITS METRIC	THIRD ANGLE PROJECTION		
		10 UNDER	±0.2	DRAWN BY T. NIITSU	DATE '02/02/08	TITLE 2.0 W/B SINGLE CONN. PLUG HOUSING ASS'Y R/A -LEAD FREE-				
		10 OVER 30 UNDER	±0.25	CHECKED BY K. ASAKAWA	DATE '03/06/12	APPROVED BY T. YAMAGUCHI '03/06/12				
		30 OVER	±0.3	ANGULAR ±3 °		MATERIAL NO. SEE CHART		DOCUMENT NO. SD-55935-002		SHEET NO. 2 OF 2
DRAFT WHERE APPLICABLE MUST REMAIN WITHIN DIMENSIONS		THIS DRAWING CONTAINS INFORMATION THAT IS PROPRIETARY TO MOLEX INCORPORATED AND SHOULD NOT BE USED WITHOUT WRITTEN PERMISSION								