

**A Dimensions: [mm]**

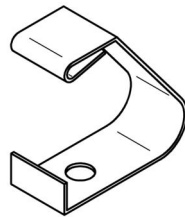

Scale - 5:1

**B Recommended land pattern: [mm]**

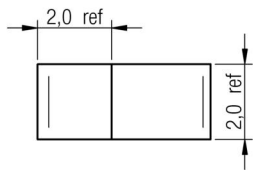
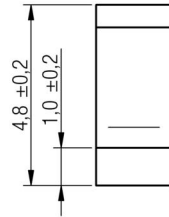
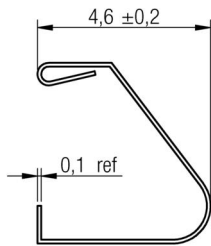
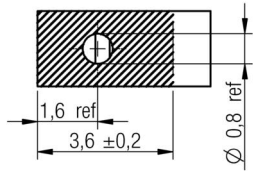
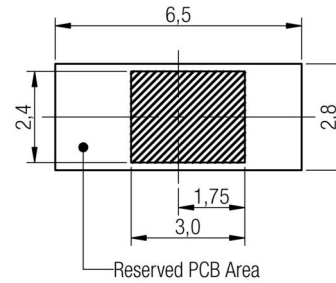

Scale - 5:1

**C Recommended compression:**

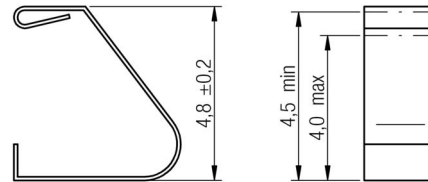

Scale - 5:1



**D Properties:**

Properties	Value
Material	Copper Beryllium (CuBe) gold-plated(AU)

**E General information:**

- Storage Temperature: -40°C to 90°C
- Operating Temperature: -40°C to 90°C

REV	DATE	BY	CHECKED	Projection	DESCRIPTION	SIZE
1.5	2014-06-11	SSt	SSt		<p><b>WE-SECF SMD EMI Contact Finger</b></p>	A4
1.4	2013-12-19	SSt	SSt			
1.3	2013-07-18	SSt	WJ			
1.2	2013-05-14	SSt	WJ			
1.1	2013-04-24	SSt	SSt			
1.0	2012-10-30	SSt	WJ			
Order.- No.	<p>Würth Elektronik eiSos GmbH &amp; Co. KG EMC &amp; Inductive Solutions Max-Eyth-Str. 1 74638 Waldenburg Germany Tel. +49 (0) 79 42 945 - 0 www.we-online.com eiSos@we-online.com</p>			<p>331011452048</p>		<p>Size: 0148</p>



**F Force Deflection Diagram:**

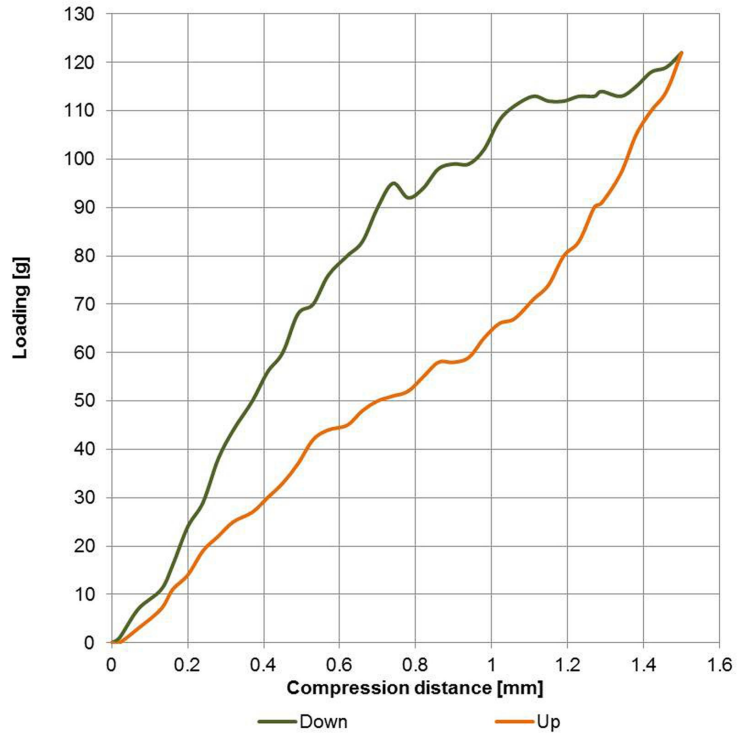

				Projection 	DESCRIPTION  <b>WE-SECF SMD EMI Contact Finger</b>
1.5	2014-06-11	SSt	SSt	Würth Elektronik eiSos GmbH & Co. KG EMC & Inductive Solutions Max-Eyth-Str. 1 74638 Waldenburg Germany Tel. +49 (0) 79 42 945 - 0 www.we-online.com eiSos@we-online.com	
1.4	2013-12-19	SSt	SSt		
1.3	2013-07-18	SSt	WJ		
1.2	2013-05-14	SSt	WJ		
1.1	2013-04-24	SSt	SSt		
1.0	2012-10-30	SSt	WJ		
REV	DATE	BY	CHECKED		Order.- No. <b>331011452048</b> Size: 0148
					SIZE A4

This electronic component has been designed and developed for usage in general electronic equipment only. This product is not authorized for use in equipment where a higher safety standard and reliability standard is especially required or where a failure of the product is reasonably expected to cause severe personal injury or death, unless the parties have executed an agreement specifically governing such use. Moreover Würth Elektronik eiSos GmbH & Co KG products are neither designed nor intended for use in areas such as military, aerospace, aviation, nuclear control, submarine, transportation (automotive control, train control, ship control), transportation signal, disaster prevention, medical, public information network etc.. Würth Elektronik eiSos GmbH & Co KG must be informed about the intent of such usage before the design-in stage. In addition, sufficient reliability evaluation checks for safety must be performed on every electronic component which is used in electrical circuits that require high safety and reliability functions or performance.

G Packaging Specification - Tape and Reel [mm]:

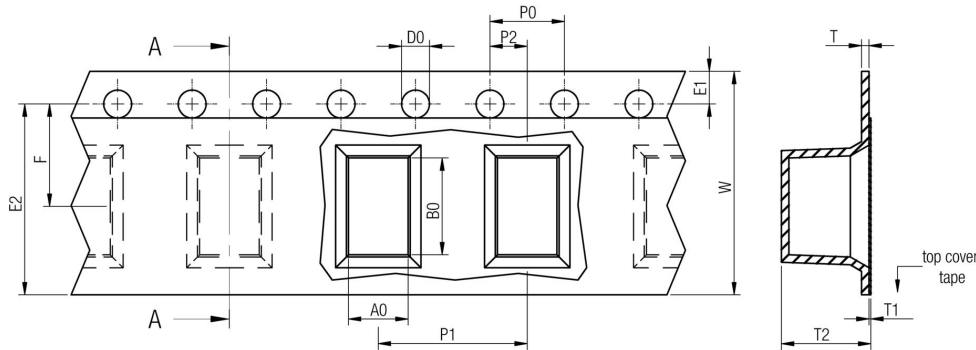

size	A0		B0		W		P1		T		T1		T2		D0		E1		E2		F		P0		P2		Tape	VPE / packaging unit
	typ.	± 0.3	typ.	± 0.1	typ.	± 0.1	max.	typ.	+0.1 -0.0	± 0.1	min.	± 0.05	± 0.1	± 0.05	typ.	± 0.1	± 0.05	typ.	± 0.3	typ.	± 0.1	± 0.05	typ.	± 0.1	± 0.05			
0135	2.20	4.90	12.00	8.00	0.40	0.10	6.30	1.50	1.75	10.25	5.50	4.00	2.00	Polystyrene	2000													
0148	2.20	4.70	16.00	8.00	0.40	0.10	7.20	1.50	1.75	14.25	7.50	4.00	2.00	Polystyrene	1500													
0320	1.60	2.85	12.00	8.00	0.30	0.10	2.50	1.50	1.75	10.25	5.50	4.00	2.00	Polystyrene	3500													
0315	1.70	3.30	12.00	8.00	0.30	0.10	2.10	1.50	1.75	10.25	5.50	4.00	2.00	Polystyrene	4500													
0453	2.25	4.25	12.00	8.00	0.40	0.10	6.00	1.50	1.75	10.25	5.50	4.00	2.00	Polystyrene	1500													
0557	2.20	4.90	12.00	8.00	0.40	0.10	6.30	1.50	1.75	10.25	5.50	4.00	2.00	Polystyrene	1500													
0610	3.20	6.20	16.00	12.00	0.50	0.10	10.70	1.50	1.75	14.25	7.50	4.00	2.00	Polystyrene	500													
0825	2.10	3.20	12.00	4.00	0.40	0.10	3.20	1.50	1.75	10.25	5.50	4.00	2.00	Polystyrene	5500													
1440	2.75	3.75	12.00	8.00	0.35	0.10	4.65	1.50	1.75	10.25	5.50	4.00	2.00	Polystyrene	2000													
1562	2.70	7.15	16.00	8.00	0.35	0.10	6.80	1.50	1.75	14.25	7.50	4.00	2.00	Polystyrene	1200													
1670	2.20	4.70	16.00	8.00	0.40	0.10	7.60	1.50	1.75	14.25	7.50	4.00	2.00	Polystyrene	1000													
1613	2.75	7.25	24.00	16.00	0.50	0.10	13.90	1.50	1.75	22.25	11.50	4.00	2.00	Polystyrene	200													
1730	2.30	3.30	12.00	8.00	0.35	0.10	3.75	1.50	1.75	10.25	5.50	4.00	2.00	Polystyrene	2500													
1735	2.20	3.20	12.00	8.00	0.35	0.10	4.60	1.50	1.75	10.25	5.50	4.00	2.00	Polystyrene	2000													
2140	3.20	5.20	12.00	8.00	0.40	0.10	4.80	1.50	1.75	10.25	5.50	4.00	2.00	Polystyrene	2000													
2240	2.10	6.10	16.00	8.00	0.40	0.10	4.60	1.50	1.75	14.25	7.50	4.00	2.00	Polystyrene	1800													

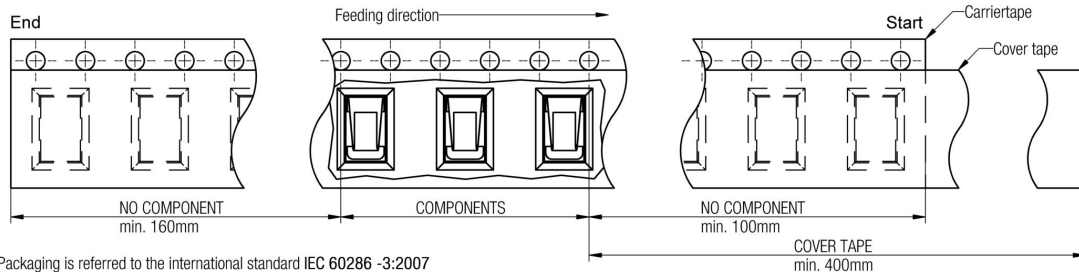

Packaging is referred to the international standard IEC 60286 - 3:2007

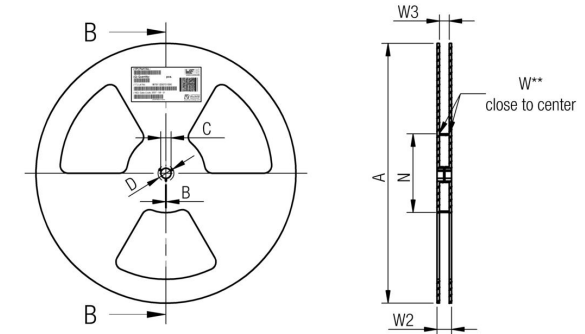

tolerance	A		B		C		D		N		W1		W2		W3		W3	
	min.	± 2.0	min.	± 0.8	min.	± 0.8	min.	± 0.8	min.	± 1.5	max.	min.	± 1.5	max.	min.	± 1.5	max.	
Tape width	12 mm	330,00	1.50	13,00	20,20	100,00	12,40	18,40	11,90	15,40	16,40	22,40	15,90	19,40	24,40	30,40	23,90	27,40
	16 mm	330,00	1.50	13,00	20,20	100,00	16,40	22,40	15,90	19,40	24,40	30,40	23,90	27,40				
	24 mm	330,00	1.50	13,00	20,20	100,00	24,40	30,40	23,90	27,40								

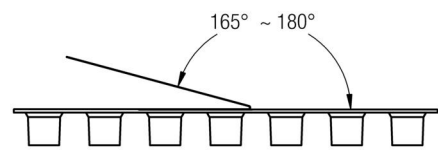
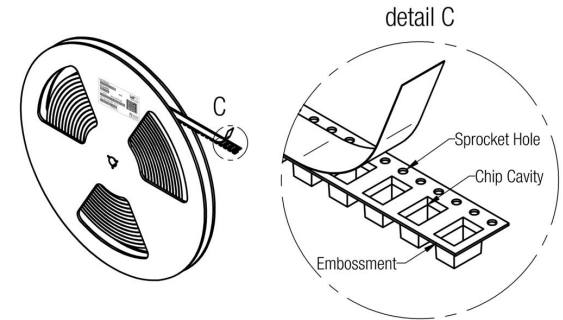

Tape width	Pull-of force	
	12 mm	0,1 N - 1,3 N
	16 mm	0,1 N - 1,3 N
24 mm	0,1 N - 1,3 N	

Projection	DATE	BY	CHECKED
	1.5	2014-06-11	SSt
	1.4	2013-12-19	SSt
	1.3	2013-07-18	WJ
	1.2	2013-05-14	WJ
	1.1	2013-04-24	SSt
	1.0	2012-10-30	WJ
	REV	DATE	BY
			CHECKED

Würth Elektronik eiSos GmbH & Co. KG  
 EMC & Inductive Solutions  
 Max-Eyth-Str. 1  
 74638 Waldenburg  
 Germany  
 Tel. +49 (0) 79 42 945 - 0  
 www.we-online.com  
 eiSos@we-online.com

DESCRIPTION		SIZE
<b>WE-SECF SMD EMI Contact Finger</b>		
Order - No.	<b>331011452048</b>	
Size: 0148		



This electronic component has been designed and developed for usage in general electronic equipment only. This product is not authorized for use in equipment where a higher safety standard and reliability standard is especially required or where a failure of the product is reasonably expected to cause severe personal injury or death, unless the parties have executed an agreement specifically governing such use. Moreover Würth Elektronik eiSos GmbH & Co KG products are neither designed nor intended for use in areas such as military, aerospace, aviation, nuclear control, submarine, transportation (automotive control, train control, ship control), transportation signal, disaster prevention, medical, public information network etc.. Würth Elektronik eiSos GmbH & Co KG must be informed about the intent of such usage before the design-in stage. In addition, sufficient reliability evaluation checks for safety must be performed on every electronic component which is used in electrical circuits that require high safety and reliability functions or performance.

## H Soldering Specifications:



### H1: Classification Reflow Profile for SMT components:



### H2: Classification Reflow Profiles

Profile Feature	Pb-Free Assembly
Preheat - Temperature Min ( $T_{smin}$ ) - Temperature Max ( $T_{smax}$ ) - Time ( $t_s$ ) from ( $T_{smin}$ to $T_{smax}$ )	150°C 200°C 60-120 seconds
Ramp-up rate ( $T_L$ to $T_p$ )	3°C/ second max.
Liquidous temperature ( $T_L$ ) Time ( $t_L$ ) maintained above $T_L$	217°C 60-150 seconds
Peak package body temperature ( $T_p$ )	See Table H3
Time within 5°C of actual peak temperature ( $t_p$ )	20-30 seconds
Ramp-down rate ( $T_p$ to $T_L$ )	6°C/ second max.
Time 25°C to peak temperature	8 minutes max.

refer to IPC/JEDEC J-STD-020D

### H3: Package Classification Reflow Temperature

	Package Thickness	Volume mm <sup>3</sup> <350	Volume mm <sup>3</sup> 350 - 2000	Volume mm <sup>3</sup> >2000
<b>PB-Free Assembly</b>	< 1.6 mm	260°C	260°C	260°C
<b>PB-Free Assembly</b>	1.6 - 2.5 mm	260°C	250°C	245°C
<b>PB-Free Assembly</b>	≥ 2.5 mm	250°C	245°C	245°C

refer to IPC/JEDEC J-STD-020D

REV	DATE	BY	CHECKED	Projection	DESCRIPTION	Order.- No.	SIZE
1.5	2014-06-11	SSt	SSt	 Würth Elektronik eiSos GmbH & Co. KG EMC & Inductive Solutions Max-Eyth-Str. 1 74638 Waldenburg Germany Tel. +49 (0) 79 42 945 - 0 www.we-online.com eiSos@we-online.com	<b>WE-SECF SMD EMI Contact Finger</b>	 <b>COMPLIANT</b> <b>RoHS&amp;REACH</b> WÜRTH ELEKTRONIK	A4
1.4	2013-12-19	SSt	SSt				
1.3	2013-07-18	SSt	WJ				
1.2	2013-05-14	SSt	WJ				
1.1	2013-04-24	SSt	SSt				
1.0	2012-10-30	SSt	WJ				
					331011452048 Size: 0148		

This electronic component has been designed and developed for usage in general electronic equipment only. This product is not authorized for use in equipment where a higher safety standard and reliability standard is especially required or where a failure of the product is reasonably expected to cause severe personal injury or death, unless the parties have executed an agreement specifically governing such use. Moreover Würth Elektronik eiSos GmbH & Co KG products are neither designed nor intended for use in areas such as military, aerospace, aviation, nuclear control, submarine, transportation (automotive control, train control, ship control), transportation signal, disaster prevention, medical, public information network etc.. Würth Elektronik eiSos GmbH & Co KG must be informed about the intent of such usage before the design-in stage. In addition, sufficient reliability evaluation checks for safety must be performed on every electronic component which is used in electrical circuits that require high safety and reliability functions or performance.

## I Cautions and Warnings:

The following conditions apply to all goods within the product series of **WE-SECF** of Würth Elektronik eiSos GmbH & Co. KG:

### General:

All recommendations according to the general technical specifications of the data sheet have to be complied with.

The responsibility for the applicability of customer specific products and use in a particular customer design is always within the authority of the customer. All technical specifications for standard products do also apply to customer specific products.



### Product specific:

Follow all instructions mentioned in the data sheet, especially:

- The soldering profile has to be complied with according to the technical reflow soldering specification, otherwise this will void the warranty.
- To avoid contact finger misplacement and the coming off the soldering joints use maximum adjusted force at the Pick- and Place machine that does not exceed the recommended compression rate (of the contact fingers).
- The soldering joints must be kept clean, dry and grease free. The contact finger should be placed onto the solder pad of the printed circuit board in a way that no tin- solder is able to come into the undermost or the first elastic bending of the contact fingers so that the bending will not be affected.
- The contact finger shall not exceed the recommended compression rate. If recommended compression rate is exceeded there is a risk that the spring will not be able to push back into the initial state.
- Do not bend the contact finger into the opposite position, as the material will overstretch and possibly break.
- Violation of the technical product specifications will void the warranty.

The general and product specific cautions comply with the state of the scientific and technical knowledge and are believed to be accurate and reliable; however, no responsibility is assumed for inaccuracies or incompleteness.

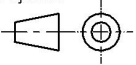

				Projection 		DESCRIPTION	
1.5	2014-06-11	SSt	SSt	Würth Elektronik eiSos GmbH & Co. KG EMC & Inductive Solutions Max-Eyth-Str. 1 74638 Waldenburg Germany Tel. +49 (0) 79 42 945 - 0 www.we-online.com eiSos@we-online.com	<b>WE-SECF SMD EMI Contact Finger</b>	Order.- No.	
1.4	2013-12-19	SSt	SSt			<b>331011452048</b> 	SIZE
1.3	2013-07-18	SSt	WJ				A4
1.2	2013-05-14	SSt	WJ				
1.1	2013-04-24	SSt	SSt				
1.0	2012-10-30	SSt	WJ				
REV	DATE	BY	CHECKED				

## J Important Notes:

The following conditions apply to all goods within the product range of Würth Elektronik eiSos GmbH & Co. KG:



### 1. General Customer Responsibility

Some goods within the product range of Würth Elektronik eiSos GmbH & Co. KG contain statements regarding general suitability for certain application areas. These statements about suitability are based on our knowledge and experience of typical requirements concerning the areas, serve as general guidance and cannot be estimated as binding statements about the suitability for a customer application. The responsibility for the applicability and use in a particular customer design is always solely within the authority of the customer. Due to this fact it is up to the customer to evaluate, where appropriate to investigate and decide whether the device with the specific product characteristics described in the product specification is valid and suitable for the respective customer application or not.

### 2. Customer Responsibility related to Specific, in particular Safety-Relevant Applications

It has to be clearly pointed out that the possibility of a malfunction of electronic components or failure before the end of the usual lifetime cannot be completely eliminated in the current state of the art, even if the products are operated within the range of the specifications.

In certain customer applications requiring a very high level of safety and especially in customer applications in which the malfunction or failure of an electronic component could endanger human life or health it must be ensured by most advanced technological aid of suitable design of the customer application that no injury or damage is caused to third parties in the event of malfunction or failure of an electronic component.

Therefore, customer is cautioned to verify that data sheets are current before placing orders. The current data sheets can be downloaded at [www.we-online.com](http://www.we-online.com).

### 3. Best Care and Attention

Any product-specific notes, cautions and warnings must be strictly observed. Any disregard will result in the loss of warranty.

### 4. Customer Support for Product Specifications

Some products within the product range may contain substances which are subject to restrictions in certain jurisdictions in order to serve specific technical requirements. Necessary information is available on request. In this case the field sales engineer or the internal sales person in charge should be contacted who will be happy to support in this matter.

### 5. Product R&D

Due to constant product improvement product specifications may change from time to time. As a standard reporting procedure of the Product Change Notification (PCN) according to the JEDEC-Standard inform about minor and major changes. In case of further queries regarding the PCN, the field sales engineer or the internal sales person in charge should be contacted. The basic responsibility of the customer as per Section 1 and 2 remains unaffected.

### 6. Product Life Cycle

Due to technical progress and economical evaluation we also reserve the right to discontinue production and delivery of products. As a standard reporting procedure of the Product Termination Notification (PTN) according to the JEDEC-Standard we will inform at an early stage about inevitable product discontinuance. According to this we cannot guarantee that all products within our product range will always be available. Therefore it needs to be verified with the field sales engineer or the internal sales person in charge about the current product availability expectancy before or when the product for application design-in disposal is considered. The approach named above does not apply in the case of individual agreements deviating from the foregoing for customer-specific products.

### 7. Property Rights

All the rights for contractual products produced by Würth Elektronik eiSos GmbH & Co. KG on the basis of ideas, development contracts as well as models or templates that are subject to copyright, patent or commercial protection supplied to the customer will remain with Würth Elektronik eiSos GmbH & Co. KG.

Würth Elektronik eiSos GmbH & Co. KG does not warrant or represent that any license, either expressed or implied, is granted under any patent right, copyright, mask work right, or other intellectual property right relating to any combination, application, or process in which Würth Elektronik eiSos GmbH & Co. KG components or services are used.

### 8. General Terms and Conditions

Unless otherwise agreed in individual contracts, all orders are subject to the current version of the "General Terms and Conditions of Würth Elektronik eiSos Group", last version available at [www.we-online.com](http://www.we-online.com).

				Projection 	DESCRIPTION	
1.5	2014-06-11	SSt	SSt	Würth Elektronik eiSos GmbH & Co. KG EMC & Inductive Solutions Max-Eyth-Str. 1 74638 Waldenburg Germany Tel. +49 (0) 79 42 945 - 0 <a href="http://www.we-online.com">www.we-online.com</a> <a href="mailto:eiSos@we-online.com">eiSos@we-online.com</a>	<b>WE-SECF SMD EMI Contact Finger</b>	
1.4	2013-12-19	SSt	SSt		Order.- No.	
1.3	2013-07-18	SSt	WJ		COMPLIANT RoHS&REACH WÜRTH ELEKTRONIK	SIZE
1.2	2013-05-14	SSt	WJ			<b>331011452048</b>
1.1	2013-04-24	SSt	SSt		Size: 0148	
1.0	2012-10-30	SSt	WJ			
REV	DATE	BY	CHECKED			