



A Leading Provider of Microcontrollers & Analog Semiconductors

## Product Change Notification - CYER-14FJTS942

---

**Date:** 07 Apr 2011  
**Product Category:** 8-bit Microcontrollers; Memory; Analog (Linear & Mixed Signal) AND Interface  
**Device Family:**   
**Notification subject:** CCB 1001: Implement Shipping label and package changes to all SST device families  
**Notification text:**

**PCN Status:**  
Final notification

**Microchip Catalog Part Numbers Affected:**  
This change applies to virtually all SST device families shipped from Microchip warehouses.

**Description of Changes:**

1. Change SST Minimum Order Quantity (MOQ) to Microchip MOQ.
2. Change SST tube standard length to Microchip standard tube length.
3. Change SST packing method to Microchip standard packing method.
4. Change SST standard shipping labels (both of inner & outer labels).
5. Change SST shipping boxes (both inner & outer boxes).

**Note:** Please review the attached document for pre and post details of the changes.

**Impacts to Data Sheet:**  
None

**Reason for Change:**  
To Improve Manufacturability

**Change Implementation Status:**  
In Progress

**Estimated First Ship Date:**  
May 16, 2011 (Date Code: 1121)

**NOTE:** Please be advised that during the transition period customers may receive pre and post char due to existing inventory of the pre changed parts.

**Markings to Distinguish Revised from Unrevised Devices:**  
Shipping labels, pink static bags, cartons, and boxes

**PCN\_CYER-14FJTS942 Document Revision History:**  
February 15, 2011: Issued final notification.

April, 7 2011: Amend PCN to add change to inner and outer shipping boxes.

**Attachment(s):** [PCN\\_CYER-14FJTS942\\_pre post change.pdf](#)

Please contact your local [Microchip sales office](#) with questions or concerns regarding this notification.

**Terms and Conditions:**

If you wish to change your product/process change notification (PCN) profile please log on to our website at <http://www.microchip.com/PCN> sign into myMICROCHIP to myMICROCHIP home page, then select a profile option from the left navigation bar.

To opt out of future offer or information emails (other than product change notification emails), click here to go to [microchipDIRECT](#) and login, then click on the "My acco

Parts Affected

SST11CP15  
SST11LN01  
SST11LP11  
SST11LP12  
SST12CP11  
SST12LF01  
SST12LF02  
SST12LF05  
SST12LN01  
SST12LP00  
SST12LP07  
SST12LP07A  
SST12LP07E  
SST12LP08  
SST12LP08A  
SST12LP14  
SST12LP14A  
SST12LP14C  
SST12LP14E  
SST12LP15  
SST12LP15A  
SST12LP15B  
SST12LP16  
SST12LP17E  
SST12LP18E  
SST12LP19E  
SST13LP02  
SST13LP05  
SST25LF020A  
SST25LF030A  
SST25LF080A  
SST25VF010A  
SST25VF016B  
SST25VF020  
SST25VF020A  
SST25VF020B  
SST25VF032B  
SST25VF040  
SST25VF040B  
SST25VF064C  
SST25VF080B  
SST25VF512  
SST25VF512A  
SST25WF010

SST25WF020  
SST25WF040  
SST25WF080  
SST25WF512  
SST26VF016  
SST26VF032  
SST26VF032A  
SST26WF016B  
SST26WF032  
SST26WF032A  
SST38VF6401  
SST38VF6402  
SST38VF6403  
SST38VF6404  
SST39LF010  
SST39LF020  
SST39LF040  
SST39LF200A  
SST39LF400A  
SST39LF512  
SST39LF800A  
SST39LF801C  
SST39LF802C  
SST39SF010A  
SST39SF020A  
SST39SF040  
SST39VF010  
SST39VF020  
SST39VF040  
SST39VF1601  
SST39VF1601C  
SST39VF1602  
SST39VF1602C  
SST39VF1681  
SST39VF1682  
SST39VF200A  
SST39VF3201  
SST39VF3201B  
SST39VF3201C  
SST39VF3202  
SST39VF3202B  
SST39VF3202C  
SST39VF400A  
SST39VF512  
SST39VF6401B  
SST39VF6402B

SST39VF800A  
SST39VF801C  
SST39VF802C  
SST39WF1601  
SST39WF1602  
SST39WF400A  
SST39WF400B  
SST39WF800A  
SST39WF800B  
SST49LF004B  
SST49LF008A  
SST49LF016C  
SST49LF020A  
SST49LF030A  
SST49LF080A  
SST49LF160C  
SST89C58RC  
SST89E516C  
SST89E516P  
SST89E516RD  
SST89E516RD2  
SST89E52RC  
SST89E54C  
SST89E54P  
SST89E54RC  
SST89E54RD2A  
SST89E54RDA  
SST89E58P  
SST89E58RD2  
SST89E58RD2A  
SST89E58RDA  
SST89V516RD  
SST89V516RD2  
SST89V54RD  
SST89V54RD2  
SST89V58RD  
SST89V58RD2



**MICROCHIP**

**PCN\_CYER-14FJTS942**

**Implement Shipping Label and Package  
Changes to SST Device Families**



# CHANGE SUMMARY

**1. CHANGE MOQ**

**2. CHANGE TUBE LENGTH**

**3. CHANGE PACKING METHOD**

**4. CHANGE INNER & OUTER SHIPPING LABELS**

**5. CHANGE INNER & OUTER SHIPPING BOXS**

---



# COMPARISON OF MINIMUM ORDER QUANTITY (MOQ) PER PACKAGE

Item	Package & Media	Change required	Pre change	Post change
1	8L SOIC 150 mils Tube	Unit / Tube Number of Tube / Bag	98 150	100 100
2	8L SOIC 150 mils T&R	Units / Reel	2200	3000
3	8L SOIC 207 mils Tube	Number of Tube / Bag	100	50
4	8L SOIC 207 mils T&R	Units / Reel	2000	2100
5	16L SOIC 300 mils	Unit / Tube Number of Tube / Bag	46 80	47 40
6	44L PLCC	Unit / Tube Number of Tube / Bag	26 50	27 20
7	8L PDIP	Unit / Tube Number of Tube / Bag	50 75	60 60
8	40L PDIP	Unit / Tube Number of Tube / Bag	9 50	10 24
9	44L TQFP T&R	Units / Reel Units / Inner box	1500 1500	1200 1200



# COMPARISON OF TUBES LENGTH PER PACKAGE

Item	Package & Media	Change required	Pre change	Post change
1	8L SOIC 150 mils Tube	Tube length (Inch)	20	20.50
2	40L PDIP	Tube length (Inch)	20.0	23.7

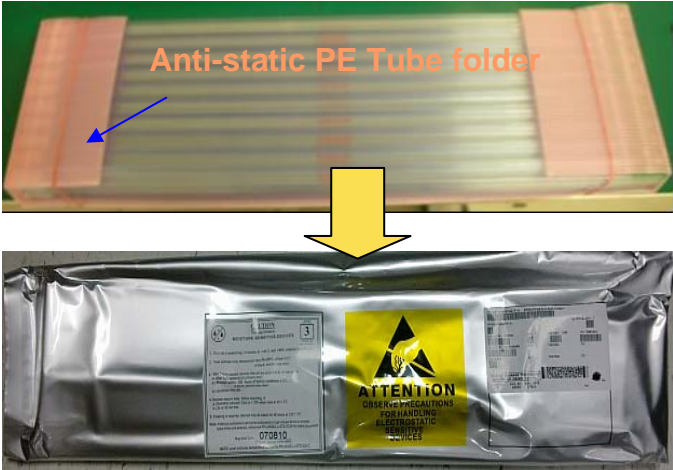
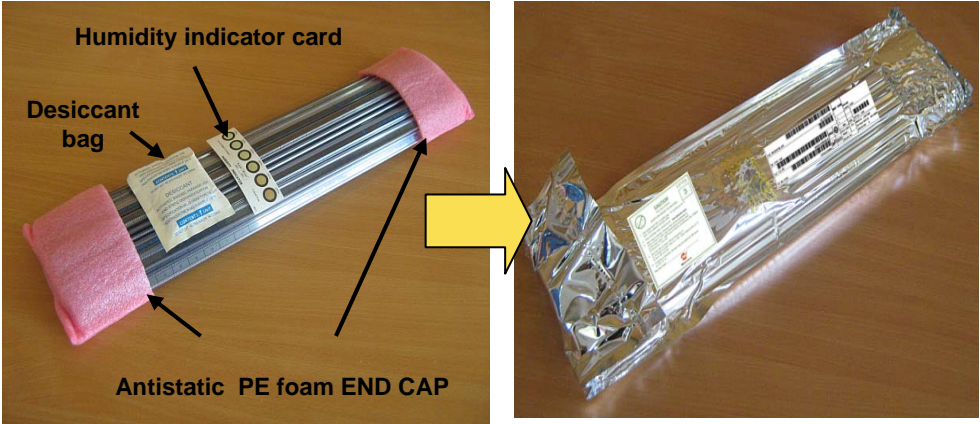

# COMPARISON OF DRY PACK TUBES

PRE CHANGE	POST CHANGE
Dry pack (MSL-3)	
 <p>The image shows the pre-change assembly process. At the top, an 'Anti-static PE Tube folder' is used to fold a tube. A yellow arrow points down to a completed silver dry pack bag. The bag features a yellow 'ATTENTION' warning label with a lightning bolt symbol and the text 'ATTENTION OBSERVE PRECAUTIONS FOR HANDLING ELECTROSTATIC SENSITIVE DEVICES'.</p>	 <p>The image shows the post-change assembly process. A tube is shown with a 'Humidity indicator card' and a 'Desiccant bag' attached. The tube is capped with 'Antistatic PE foam END CAP'. A yellow arrow points to the final product, a clear plastic bag containing the tube and its components.</p>

# COMPARISON OF DRY PACK TAPE & REEL

## PRE CHANGE

## POST CHANGE

Dry pack (MSL-3)

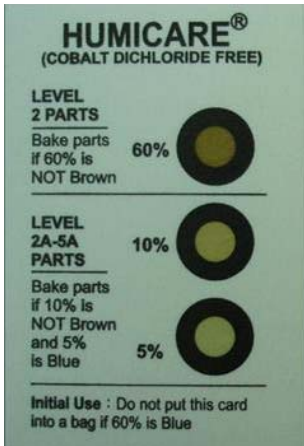

**HIC: 3 spot**

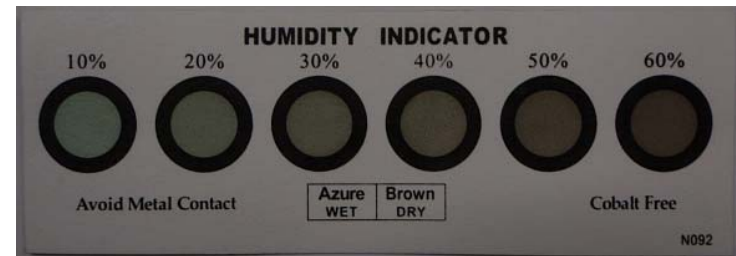



**HIC: 6 spot**

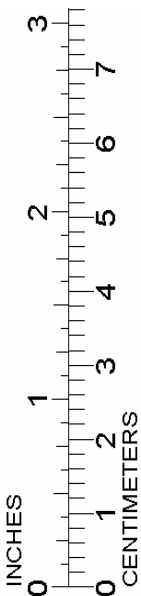

# INNER LABEL

## PRE-CHANGE



(1P) SST MARKETING P/N: 1234567890123456789012345678901  RoHS

(P) CUSTOMER P/N: 12345678901234567890123456789 (Q) TOTAL QTY: 1234567

(2S) LOT#: 123456789012 QTY: 123456 Test Date: 12345678 DC: 12345678901

(2S) LOT#: 123456789012 QTY: 123456 Test Date: 12345678 DC: 12345678901

(2S) LOT#: 123456789012 QTY: 123456 Test Date: 12345678 DC: 12345678901

SILICON STORAGE TECHNOLOGY  
COUNTRY OF ORIGIN: 12345678

LOCATION: PKG. BY: SEAL DATE:  
12345 123456 123456

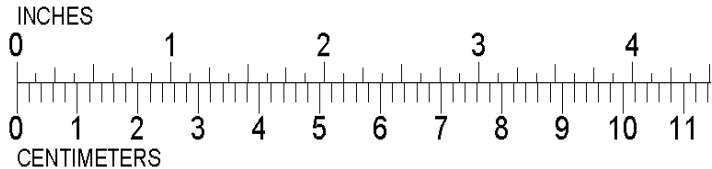

123456789012 

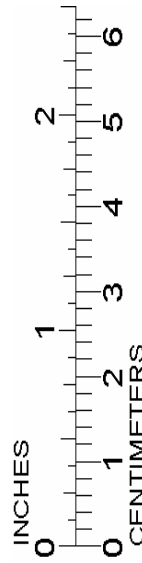

## POST-CHANGE



(1P) CATALOG P/N: SST39VF199Z-70-41-B3KE-CC999-T

(1T) LOT NO.: 113201494000MTAI  RoHS  

(P) CUST. P/N: 1234567890 MSL: 1/260°C (Q) QTY: 6210

LEADS: 8

MPC: 77186TC2XV01

	DC	QTY
WAFER QTY: 50	1045	3102
WAFER REV: A	1033	198
RETEST D/C: 1055	1034	2910
WAFER LOT: TMPE210108326.210		

ID#: (001) TRACE CODE: 10450MJ, 10330EK, 10450MJ, 10450MJ, 10450MJ, 10450MJ

B04472/TC09

MADE IN THAILAND

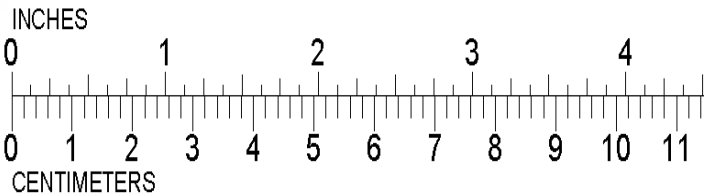

# 7 Inch Reel Inner Box

## PRE-CHANGE

Dimension: (W x L x H)  
204 x 220 x 35 mm.

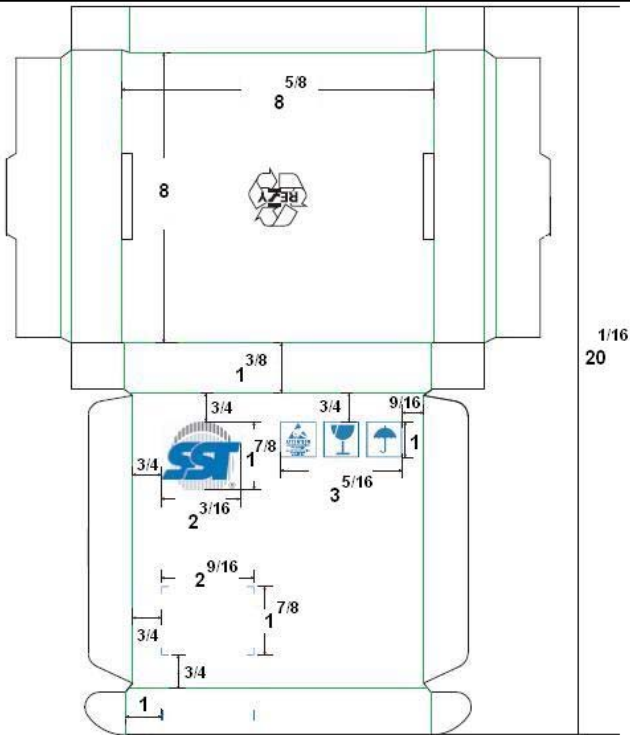

## POST CHANGE

Dimension: (W x L x H)  
204 x 220 x 35 mm.

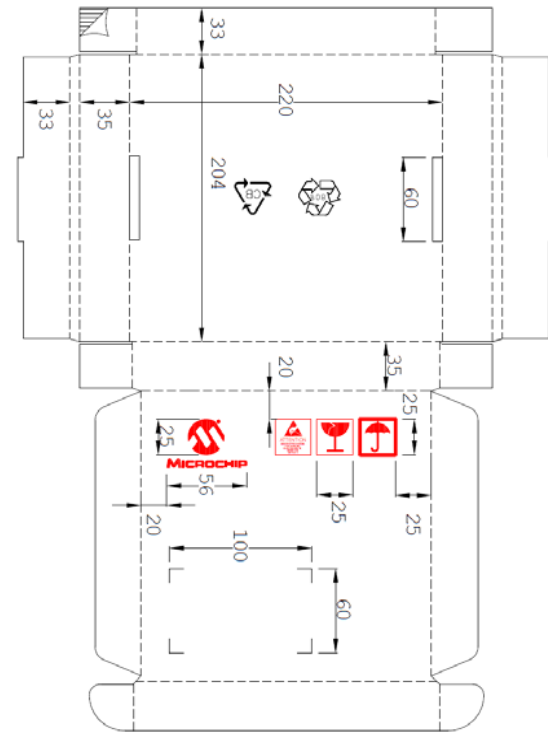

# 7 Inch Reel Outer Carton

## PRE-CHANGE:

Dimension (W x L x H)  
205x460x228 mm.

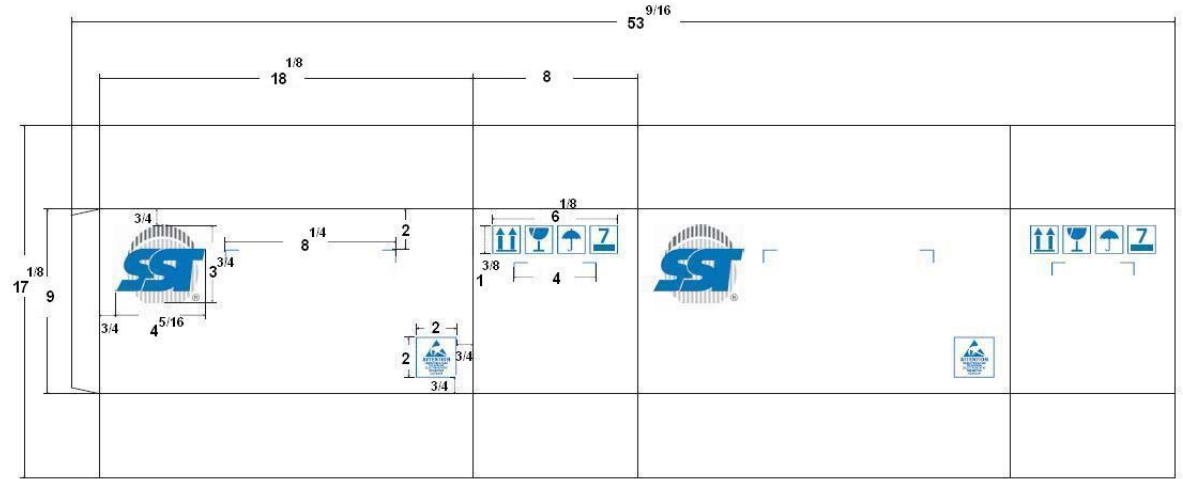

## POST CHANGE:

Dimension (W x L x H)  
205x460x228 mm.

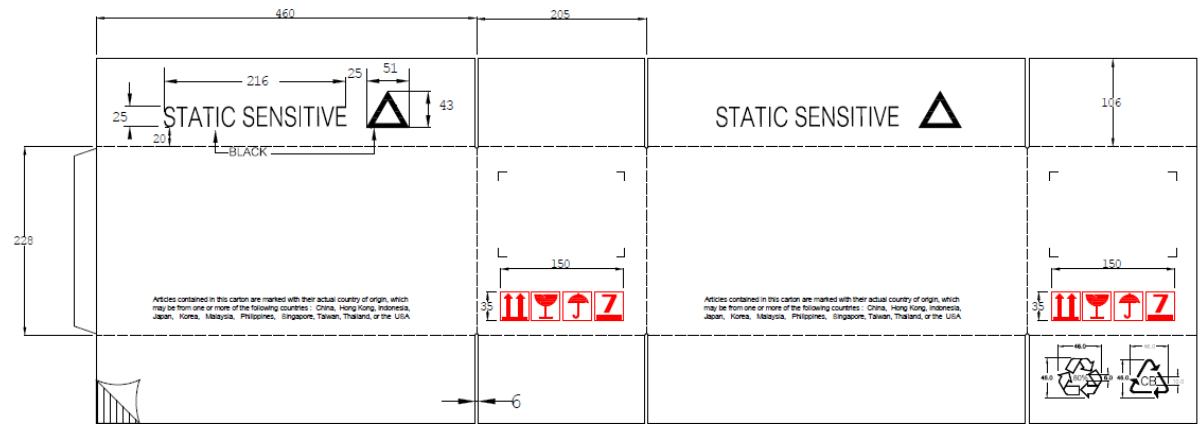



# 13 Inch Reel Outer Carton

## PRE-CHANGE

Dimension: (W x L x H)  
226 x 375 x 362 mm

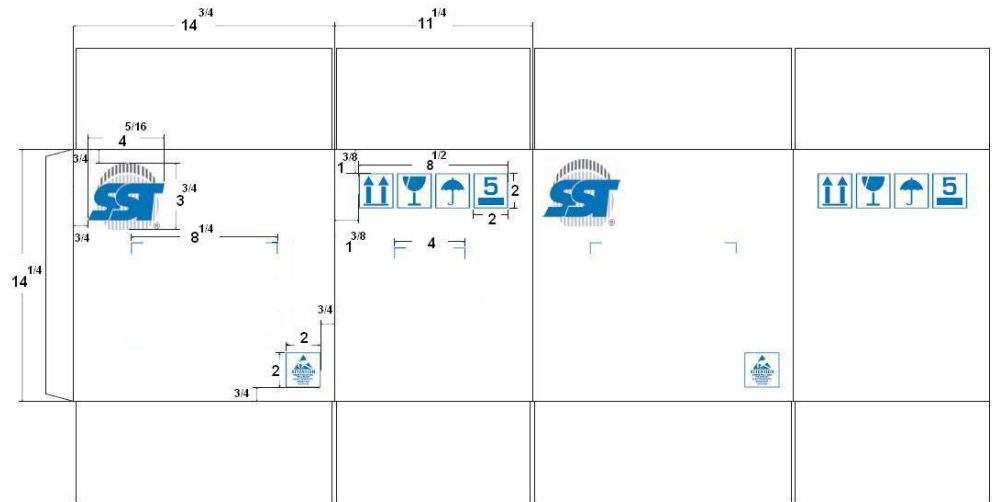

## POST CHANGE

Dimension: (W x L x H) 226  
x 375 x 362 mm

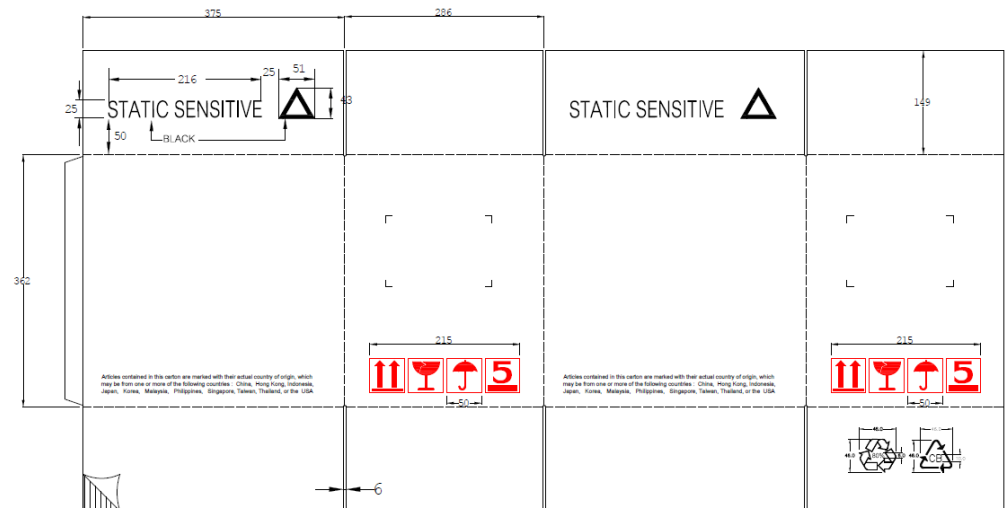



# PDIP/PLCC tubes Inner box

## PRE-CHANGE

Dimension: 200 x **544.5** x 80 mm

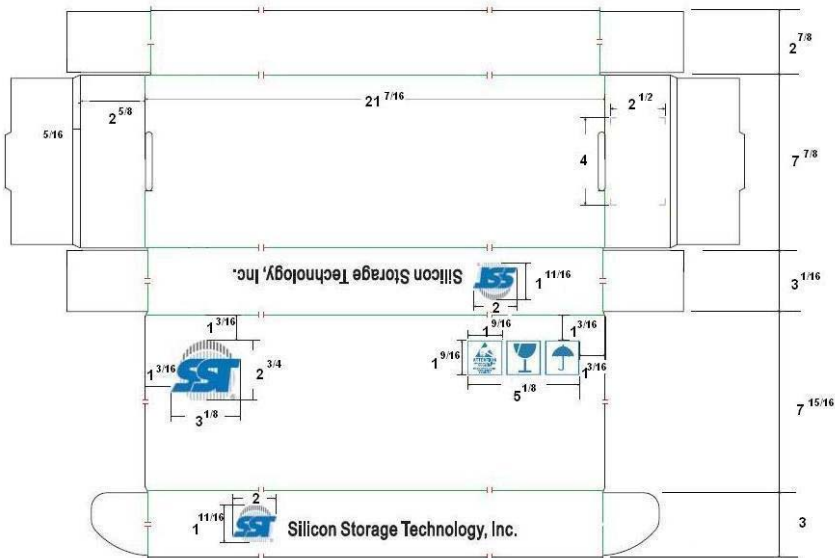

## POST CHANGE

Dimension: 200 x **638** x 80 mm

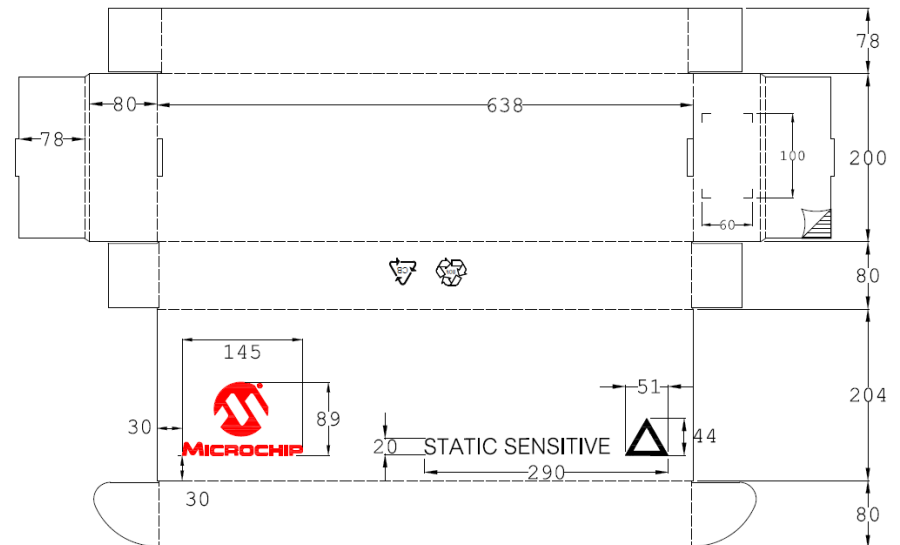

# PDIP/PLCC tubes Outer Carton

## PRE-CHANGE

Dimension:  
430 x **559** x 187.5 mm

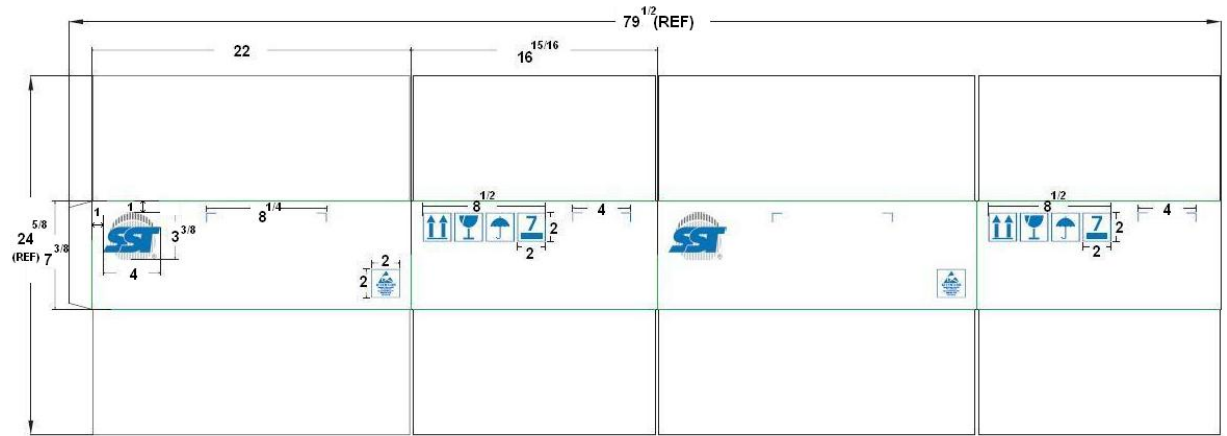

## POST CHANGE

Dimension:  
430 x **657** x 187.5 mm

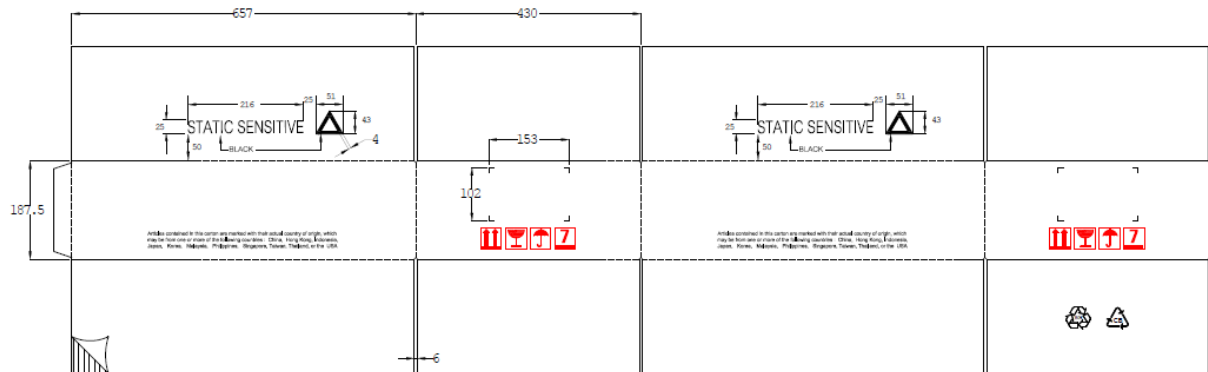

# SOIC/SON/QFN tubes Inner box

## PRE-CHANGE

Dimension: 129 x **544.5** x 80 mm

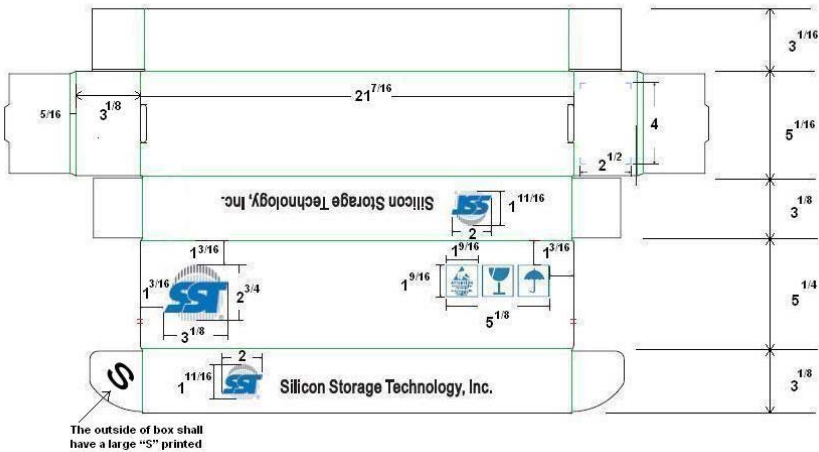

## POST CHANGE

Dimension: 129 x **565** x 80 mm

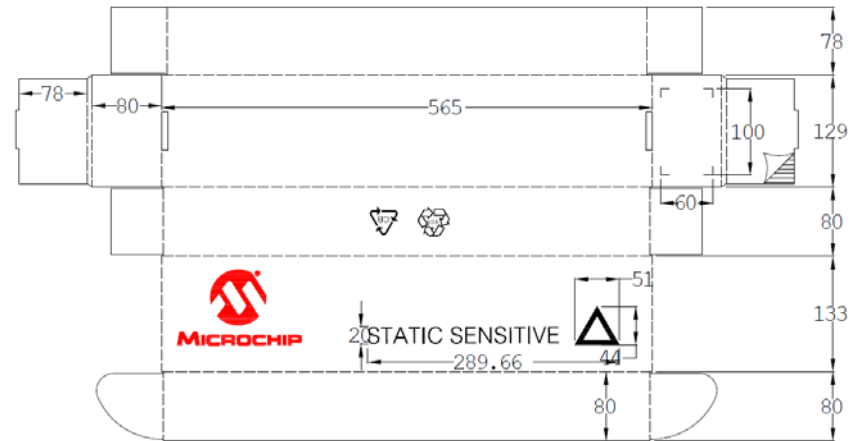



# Tray Inner box

## PRE-CHANGE

Dimension: 162 x 371.5 x 88 mm

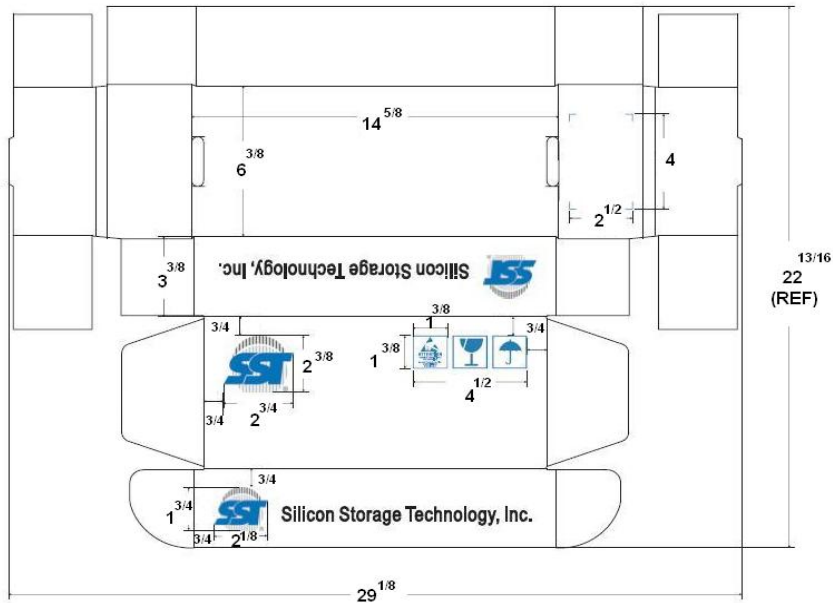

## POST CHANGE

Dimension: 162 x 371.5 x 88 mm

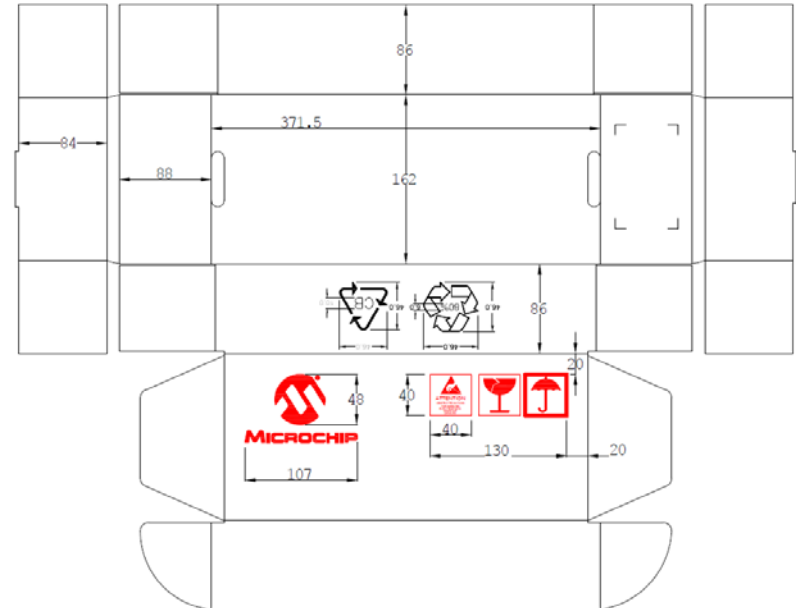

# Tray Outer Carton

## PRE-CHANGE

Dimension:  
345 x 392 x 195 mm

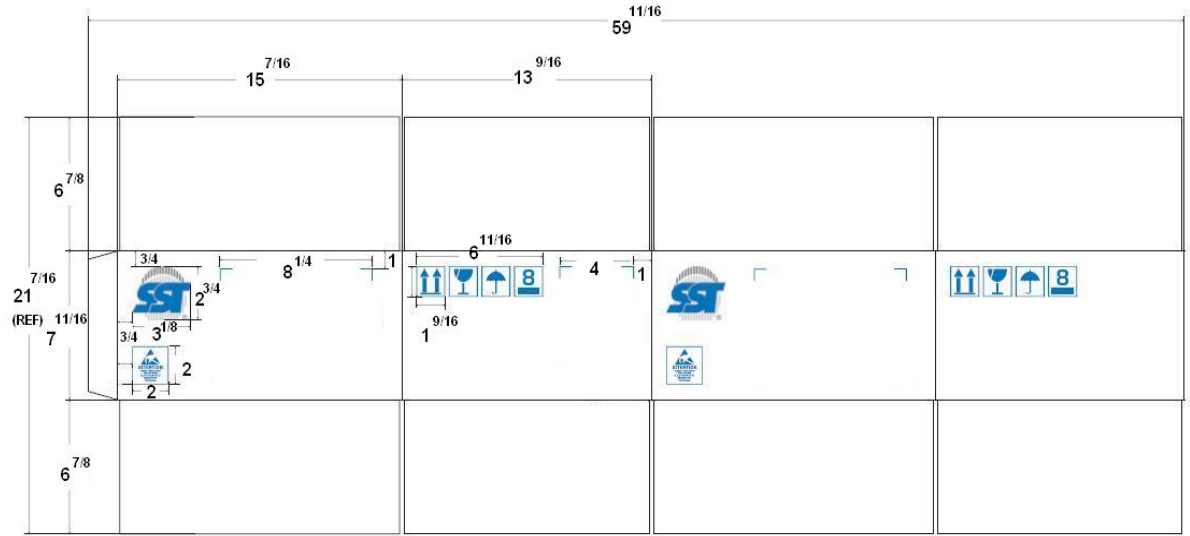

## POST CHANGE

Dimension:  
345 x 392 x 195 mm

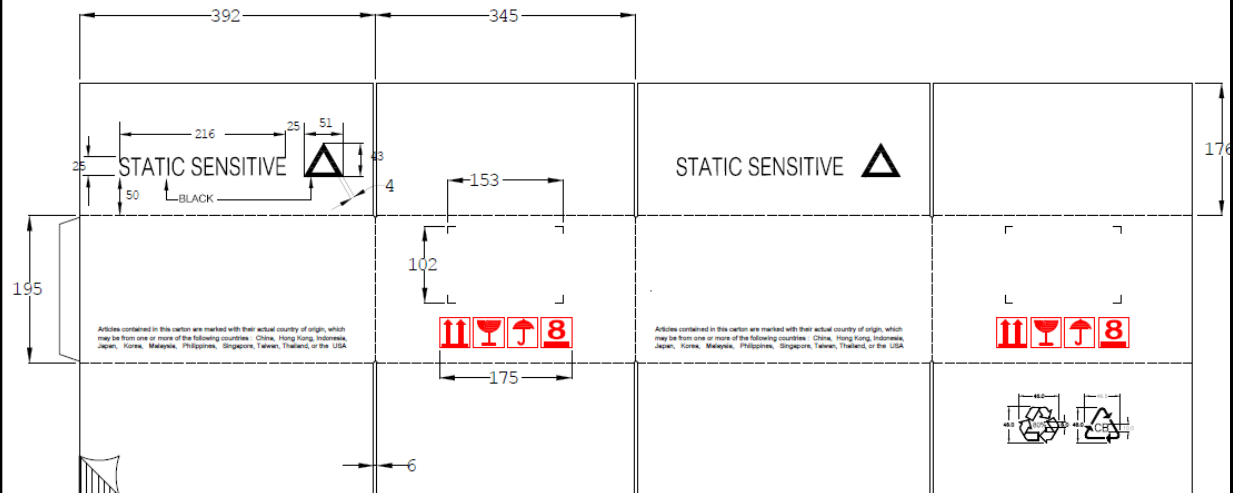

on "Update profile" and un-check the box that states "Future offers or information about Microchip's products or services."