



N-Channel Depletion-Mode Vertical DMOS FETs

Features

- ▶ High input impedance
- ▶ Low input capacitance
- ▶ Fast switching speeds
- ▶ Low on-resistance
- ▶ Free from secondary breakdown
- ▶ Low input and output leakage

Applications

- ▶ Normally-on switches
- ▶ Solid state relays
- ▶ Converters
- ▶ Linear amplifiers
- ▶ Constant current sources
- ▶ Power supply circuits
- ▶ Telecom

Ordering Information

Part Number	Package Option	Packing
DN3535N8-G	TO-243AA (SOT-89)	2000/Reel

-G denotes a lead (Pb)-free / RoHS compliant package.

Contact factory for Wafer / Die availability.

Devices in Wafer / Die form are lead (Pb)-free / RoHS compliant.

Absolute Maximum Ratings

Parameter	Value
Drain-to-source voltage	BV_{DSX}
Drain-to-gate voltage	BV_{DGX}
Gate-to-source voltage	$\pm 20V$
Operating and storage temperature	$-55^{\circ}C$ to $+150^{\circ}C$

Absolute Maximum Ratings are those values beyond which damage to the device may occur. Functional operation under these conditions is not implied. Continuous operation of the device at the absolute rating level may affect device reliability. All voltages are referenced to device ground.

Typical Thermal Resistance

Package	θ_{ja}
TO-243AA (SOT-89)	$133^{\circ}C/W^{\ddagger}$

Notes:

\ddagger Mounted on FR4 board, 25mm x 25mm x 1.57mm.

General Description

This low threshold depletion-mode (normally-on) transistor utilizes an advanced vertical DMOS structure and Supertex's well-proven silicon-gate manufacturing process. This combination produces a device with the power handling capabilities of bipolar transistors and with the high input impedance and positive temperature coefficient inherent in MOS devices. Characteristic of all MOS structures, this device is free from thermal runaway and thermally-induced secondary breakdown.

Supertex's vertical DMOS FETs are ideally suited to a wide range of switching and amplifying applications where high breakdown voltage, high input impedance, low input capacitance, and fast switching speeds are desired.

Product Summary

BV_{DSX}/BV_{DGX}	$R_{DS(ON)}$ (max)	I_{DSS} (min)
350V	10 Ω	200mA

Pin Configuration

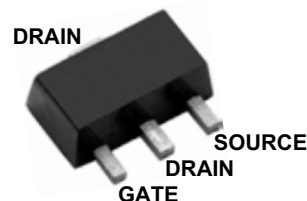

TO-243AA (SOT-89)

Product Marking

DN5SW

W = Code for week sealed
 _____ = "Green" Packaging

Package may or may not include the following marks: Si or

TO-243AA (SOT-89)

Thermal Characteristics

Package	I_D (continuous) [†]	I_D (pulsed)	Power Dissipation @ $T_A = 25^\circ\text{C}$	I_{DR} [†]	I_{DRM}
TO-243AA	230mA	500mA	1.6W [‡]	230mA	500mA

Notes:

- [†] I_D (continuous) is limited by max rated T_j .
- [‡] Mounted on FR4 board, 25mm x 25mm x 1.57mm.

Electrical Characteristics ($T_A = 25^\circ\text{C}$ unless otherwise specified)

Sym	Parameter	Min	Typ	Max	Units	Conditions
BV_{DSS}	Drain-to-source breakdown voltage	350	-	-	V	$V_{GS} = -5.0V, I_D = 1.0\mu A$
$V_{GS(OFF)}$	Gate-to-source off voltage	-1.5	-	-3.5	V	$V_{DS} = 15V, I_D = 10\mu A$
$\Delta V_{GS(OFF)}$	Change in $V_{GS(OFF)}$ with temperature	-	-	-4.5	mV/°C	$V_{DS} = 15V, I_D = 10\mu A$
I_{GSS}	Gate body leakage current	-	-	100	nA	$V_{GS} = \pm 20V, V_{DS} = 0V$
$I_{D(OFF)}$	Drain-to-source leakage current	-	-	1.0	μA	$V_{DS} = \text{Max rating}, V_{GS} = -5.0V$
		-	-	1.0	mA	$V_{DS} = 0.8 \text{ Max Rating}, V_{GS} = -5.0V, T_A = 125^\circ\text{C}$
I_{DSS}	Saturated drain-to-source current	200	-	-	mA	$V_{GS} = 0V, V_{DS} = 15V$
$R_{DS(ON)}$	Static drain-to-source on-state resistance	-	-	10	Ω	$V_{GS} = 0V, I_D = 150mA$
$\Delta R_{DS(ON)}$	Change in $R_{DS(ON)}$ with temperature	-	-	1.1	%/°C	$V_{GS} = 0V, I_D = 150mA$
G_{FS}	Forward transconductance	200	-	-	mmho	$V_{DS} = 10V, I_D = 100mA$
C_{ISS}	Input capacitance	-	-	360	pF	$V_{GS} = -5.0V, V_{DS} = 25V, f = 1.0MHz$
C_{OSS}	Common source output capacitance	-	-	40		
C_{RSS}	Reverse transfer capacitance	-	-	10		
$t_{d(ON)}$	Turn-on delay time	-	-	15	ns	$V_{DD} = 25V, I_D = 150mA, R_{GEN} = 25\Omega, V_{GS} = 0V \text{ to } -10V$
t_r	Rise time	-	-	20		
$t_{d(OFF)}$	Turn-off delay time	-	-	20		
t_f	Fall time	-	-	30		
V_{SD}	Diode forward voltage drop	-	-	1.8	V	$V_{GS} = -5.0V, I_{SD} = 150mA$
t_{rr}	Reverse recovery time	-	800	-	ns	$V_{GS} = -5.0V, I_{SD} = 150mA$

Notes:

1. All D.C. parameters 100% tested at 25°C unless otherwise stated. (Pulse test: 300 μs pulse, 2% duty cycle.)
2. All A.C. parameters sample tested.

Switching Waveforms and Test Circuit

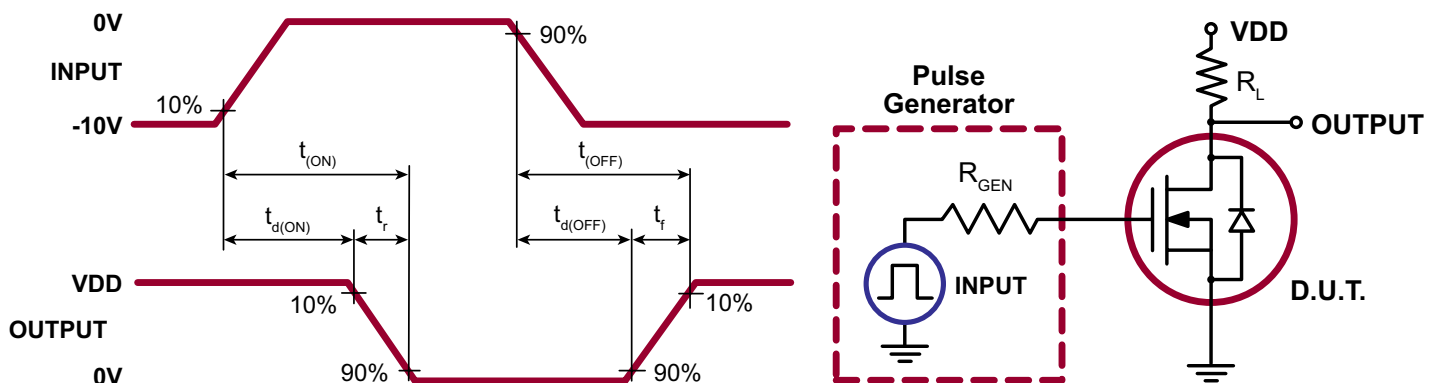

Typical Performance Curves

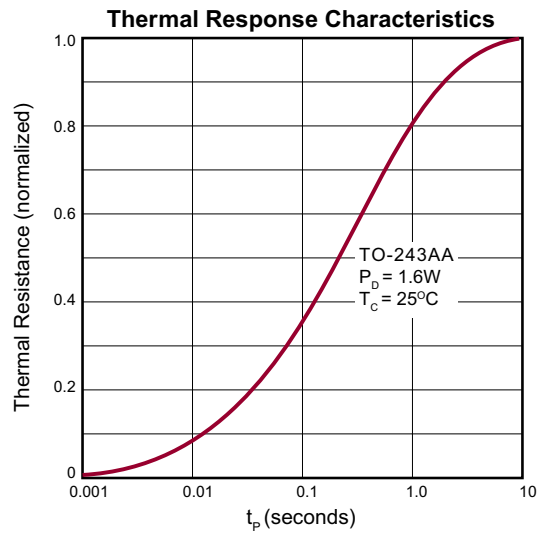
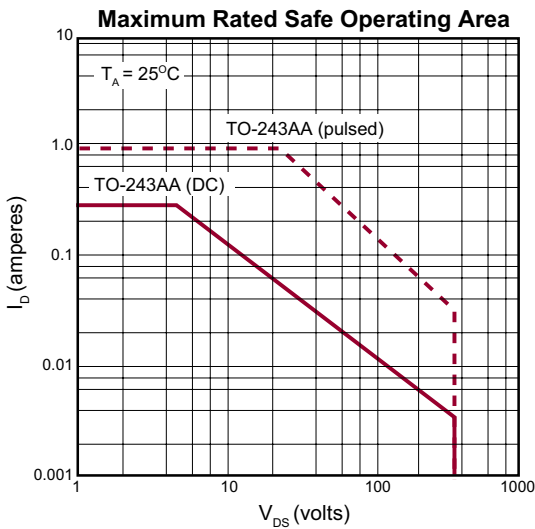
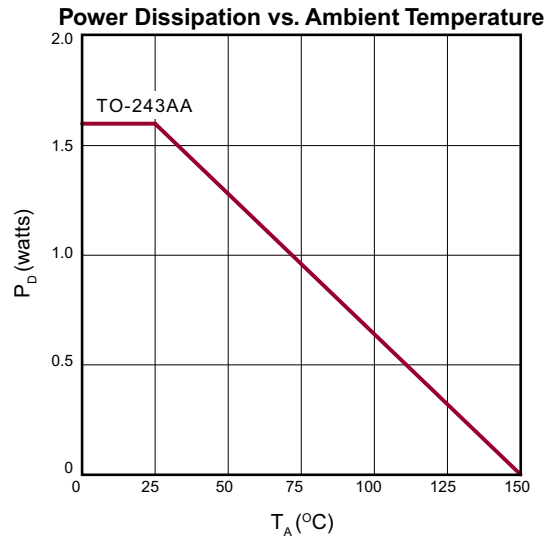
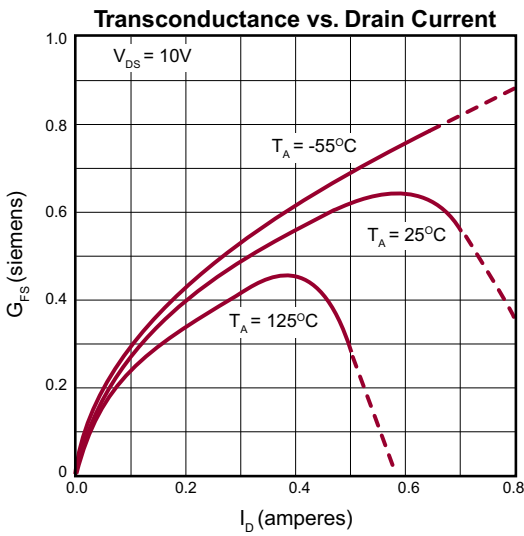
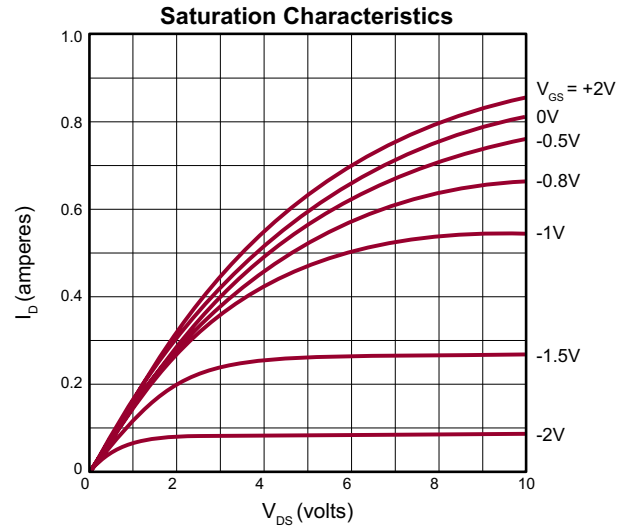
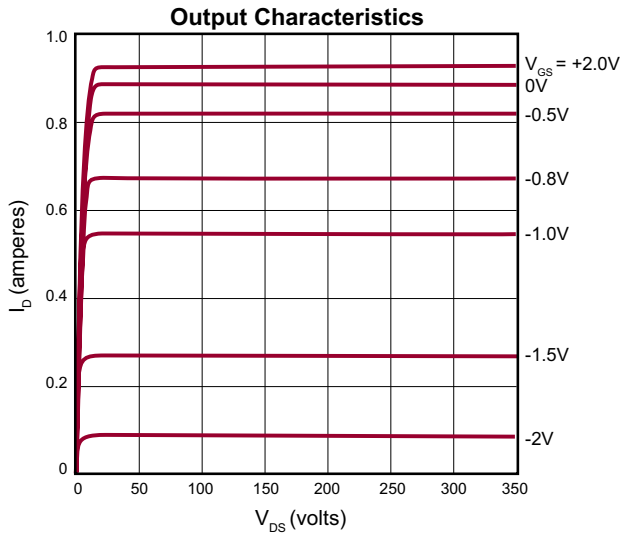

Typical Performance Curves (cont.)

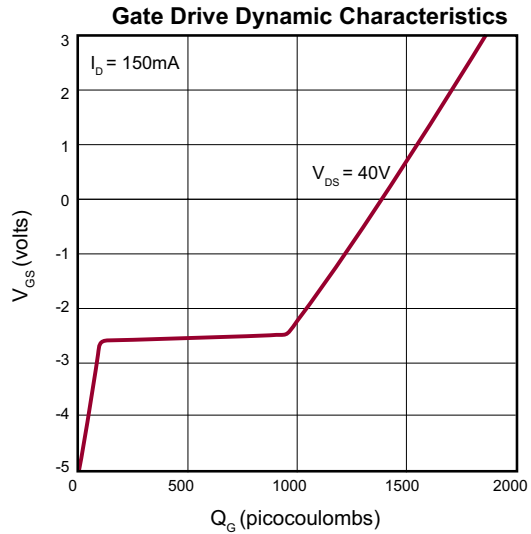
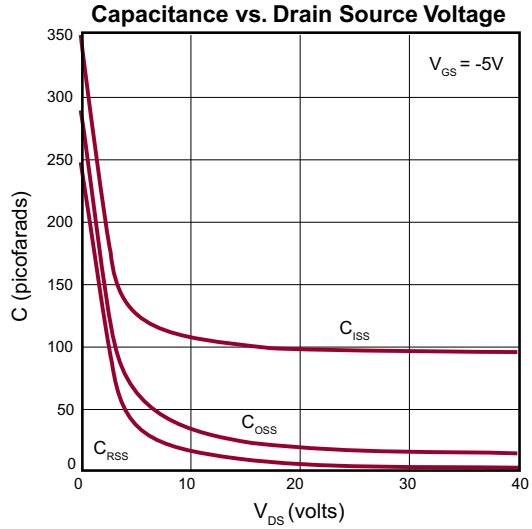
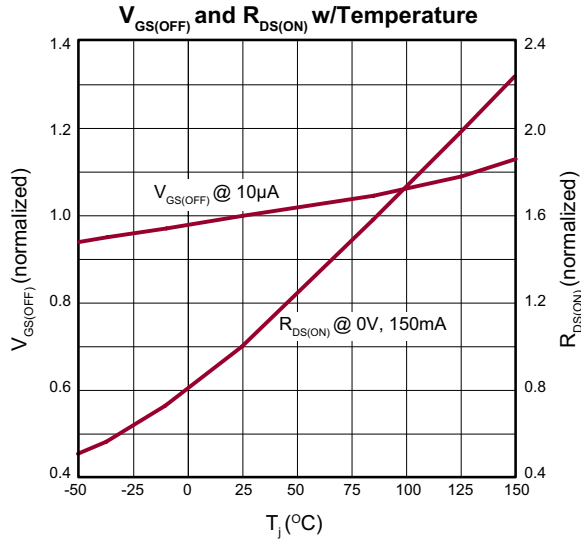
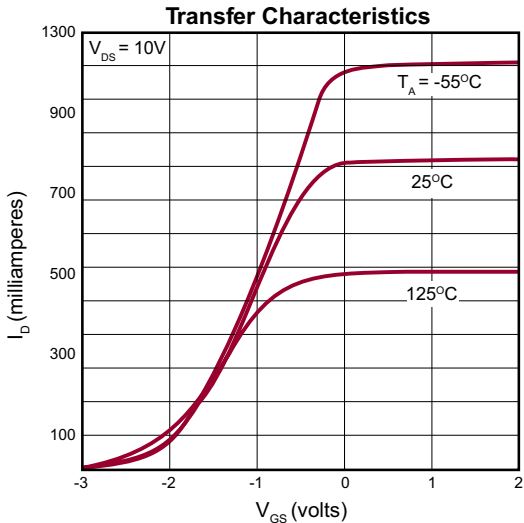
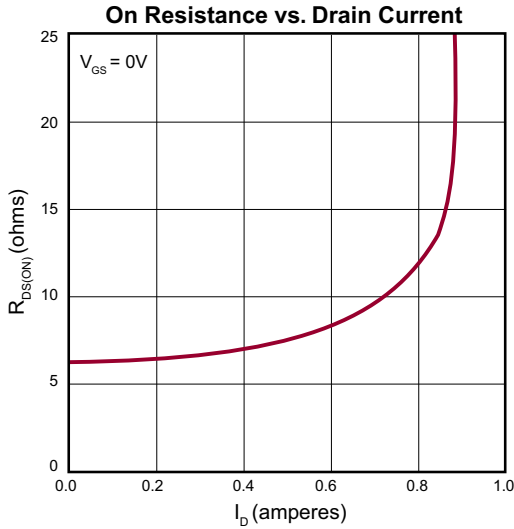
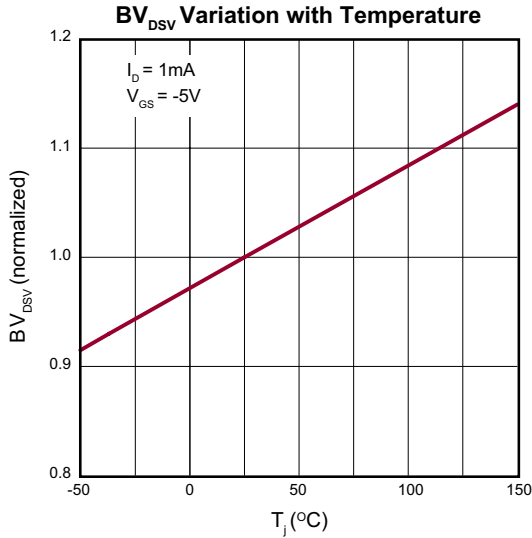

3-Lead TO-243AA (SOT-89) Package Outline (N8)

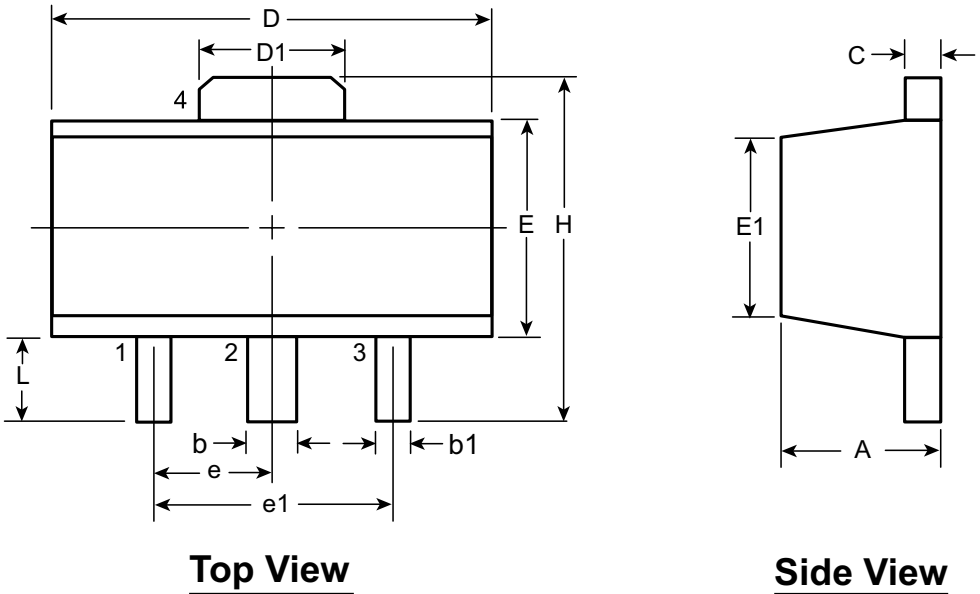

Top View

Side View

Symbol		A	b	b1	C	D	D1	E	E1	e	e1	H	L		
Dimensions (mm)	MIN	1.40	0.44	0.36	0.35	4.40	1.62	2.29	2.00†	1.50 BSC	3.00 BSC	3.94	0.73†		
	NOM	-	-	-	-	-	-	-	-			-	-	-	-
	MAX	1.60	0.56	0.48	0.44	4.60	1.83	2.60	2.29			4.25	1.20		

JEDEC Registration TO-243, Variation AA, Issue C, July 1986.

† This dimension differs from the JEDEC drawing

Drawings not to scale.

Supertex Doc. #: DSPD-3TO243AAN8, Version F111010.

(The package drawing(s) in this data sheet may not reflect the most current specifications. For the latest package outline information go to <http://www.supertex.com/packaging.html>.)

Supertex inc. does not recommend the use of its products in life support applications, and will not knowingly sell them for use in such applications unless it receives an adequate "product liability indemnification insurance agreement." **Supertex inc.** does not assume responsibility for use of devices described, and limits its liability to the replacement of the devices determined defective due to workmanship. No responsibility is assumed for possible omissions and inaccuracies. Circuitry and specifications are subject to change without notice. For the latest product specifications refer to the **Supertex inc.** (website: <http://www.supertex.com>)