



The Infinite Bandwidth Company™

MIC5250

Dual 150mA μ Cap CMOS LDO Regulator

OBSOLETE

General Description

The MIC5250 is an efficient, precise dual CMOS voltage regulator optimized for ultra-low-noise applications. The MIC5250 offers better than 1% initial accuracy, extremely low dropout voltage (typically 150mV at 150mA) and constant ground current over load (typically 100 μ A). The MIC5250 provides a very-low-noise output, ideal for RF applications where quiet voltage sources are required. A noise bypass pin is also available for further reduction of output noise.

Designed specifically for hand-held and battery-powered devices, the MIC5250 provides TTL logic compatible enable pins. When disabled, power consumption drops nearly to zero.

The MIC5250 also works with low-ESR ceramic capacitors, reducing the amount of board space necessary for power applications, critical in hand-held wireless devices.

Key features include current limit, thermal shutdown, push-pull outputs for faster transient response, and active clamps to speed up device turnoff. Available in the 10-lead MSOP (micro-shrink-outline package), the MIC5250 also offers a range of fixed output voltages.

Features

- Ultralow dropout—100mV @ 100mA
- Ultralow noise—30 μ V(rms)
- Stability with ceramic, tantalum, or aluminum electrolytic capacitors
- Load independent, ultralow ground current
- 150mA output current
- Current limiting
- Thermal Shutdown
- Tight load and line regulation
- "Zero" off-mode current
- Fast transient response
- TTL-Logic-controlled enable input

Applications

- Cellular phones and pagers
- Cellular accessories
- Battery-powered equipment
- Laptop, notebook, and palmtop computers
- PCMCIA V_{CC} and V_{PP} regulation/switching
- Consumer/personal electronics
- SMPS post-regulator/dc-to-dc modules
- High-efficiency linear power supplies

Ordering Information

Part Number	Voltage	Junction Temp. Range	Package
MIC5250-2.7BMM	2.7V	-40°C to +125°C	10-lead MSOP
MIC5250-2.8BMM	2.8V	-40°C to +125°C	10-lead MSOP
MIC5250-3.0BMM	3.0V	-40°C to +125°C	10-lead MSOP
MIC5250-3.3BMM	3.3V	-40°C to +125°C	10-lead MSOP

Other voltages available. Contact Micrel for details.

Typical Application

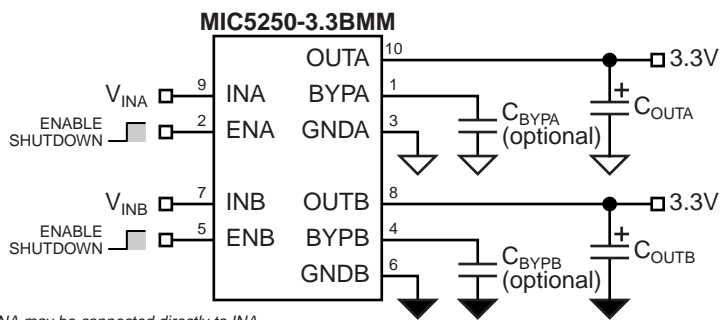

ENA may be connected directly to INA.
 ENB may be connected directly to INB.
 GNDA and GND B may be connected to isolated grounds or the same ground.

Dual Ultra-Low-Noise Regulator Circuit

Pin Configuration

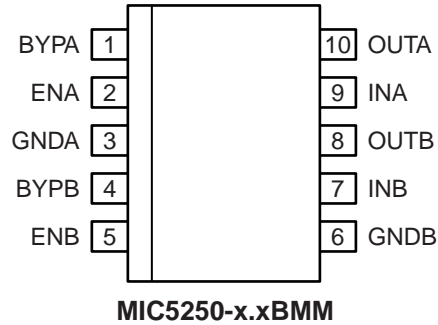

Pin Description

Pin Number	Pin Name	Pin Function
9 / 7	INA / B	Supply Input*
3 / 6	GNDA / B	Ground*
2 / 4	ENA / B	Enable/Shutdown (Input): CMOS compatible input. Logic high = enable; logic low = shutdown. Do not leave open.
1 / 4	BYPA / B	Reference Bypass: Connect external 0.01 μ F capacitor to GND to reduce output noise. May be left open.
10 / 8	OUTA / B	Regulator Output

* Supply inputs and grounds are fully isolated.

Absolute Maximum Ratings (Note 1)

Supply Input Voltage (V_{IN})	0V to +7V
Enable Input Voltage (V_{EN})	0V to +7V
Junction Temperature (T_J)	+150°C
Storage Temperature	-65°C to +150°C
Lead Temperature (soldering, 5 sec.)	260°C

ESD, Note 3

Operating Ratings (Note 2)

Input Voltage (V_{IN})	+2.7V to +6V
Enable Input Voltage (V_{EN})	0V to V_{IN}
Junction Temperature (T_J)	-40°C to +125°C
Thermal Resistance (θ_{JA})	200°C/W

Electrical Characteristics

Each regulator: $V_{IN} = V_{OUT} + 1V$, $V_{EN} = V_{IN}$; $I_{OUT} = 100\mu A$; $T_J = 25^\circ C$, **bold** values indicate $-40^\circ C \leq T_J \leq +125^\circ C$; unless noted.

Symbol	Parameter	Conditions	Min	Typical	Max	Units
V_O	Output Voltage Accuracy	$I_{OUT} = 0mA$	-1		1	%
			-2		2	%
ΔV_{LNR}	Line Regulation	$V_{IN} = V_{OUT} + 1V$ to 6V	-0.3	0	0.3	%/V
ΔV_{LDR}	Load Regulation	$I_{OUT} = 0.1mA$ to 150mA, Note 4		2.0	3.0	%
$V_{IN} - V_{OUT}$	Dropout Voltage, Note 5	$I_{OUT} = 100\mu A$		1.5	5	mV
		$I_{OUT} = 50mA$		50	85	mV
		$I_{OUT} = 100mA$		100	150	mV
		$I_{OUT} = 150mA$		150	200 250	mV mV
I_Q	Quiescent Current	$V_{EN} \leq 0.4V$ (shutdown)		0.2	1	μA
I_{GND}	Ground Pin Current, Note 6	$I_{OUT} = 0mA$		100	150	μA
		$I_{OUT} = 150mA$		100		μA
PSRR	Power Supply Rejection	$f = 120Hz$, $C_{OUT} = 10\mu F$, $C_{BYP} = 0.01\mu F$		50		dB
I_{LIM}	Current Limit	$V_{OUT} = 0V$	160	300		mA
e_n	Output Voltage Noise	$C_{OUT} = 10\mu F$, $C_{BYP} = 0.01\mu F$, $f = 10Hz$ to 100kHz		30		$\mu V(rms)$

Enable Input

V_{IL}	Enable Input Logic-Low Voltage	$V_{IN} = 2.7V$ to 5.5V, regulator shutdown		0.8	0.4	V
V_{IH}	Enable Input Logic-High Voltage	$V_{IN} = 2.7V$ to 5.5V, regulator enabled	2.0	1		V
I_{EN}	Enable Input Current	$V_{IL} \leq 0.4V$		0.17		μA
		$V_{IH} \geq 2.0V$		1.5		μA
	Shutdown Resistance Discharge			500		Ω

Thermal Protection

	Thermal Shutdown Temperature			150		$^\circ C$
	Thermal Shutdown Hysteresis			10		$^\circ C$

Note 1. Exceeding the absolute maximum rating may damage the device.

Note 2. The device is not guaranteed to function outside its operating rating.

Note 3. Devices are ESD sensitive. Handling precautions recommended.

Note 4. Regulation is measured at constant junction temperature using low duty cycle pulse testing. Parts are tested for load regulation in the load range from 0.1mA to 150mA. Changes in output voltage due to heating effects are covered by the thermal regulation specification.

Note 5. Dropout Voltage is defined as the input to output differential at which the output voltage drops 2% below its nominal value measured at 1V differential.

Note 6. Ground pin current is the regulator quiescent current. The total current drawn from the supply is the sum of the load current plus the ground pin current.

Typical Characteristics

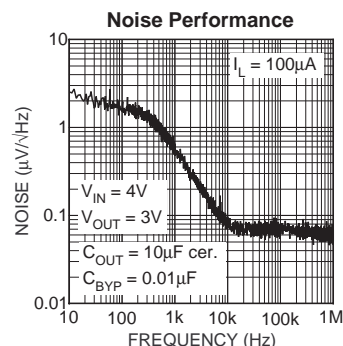
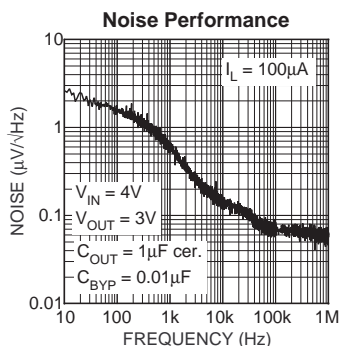
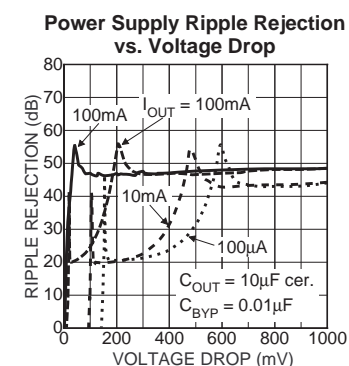
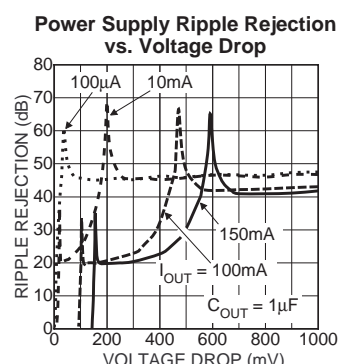
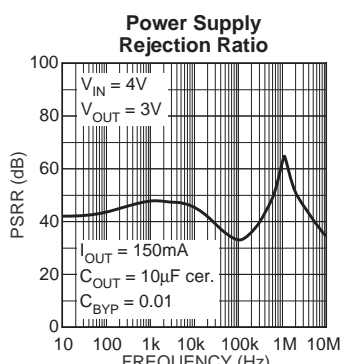
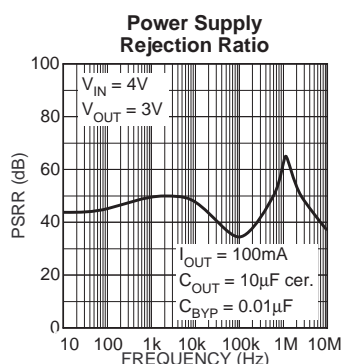
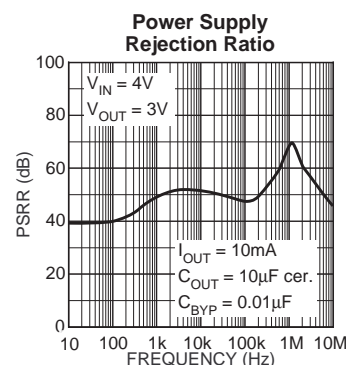
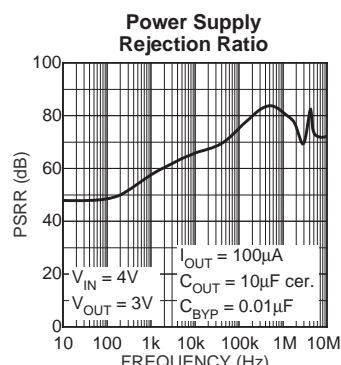
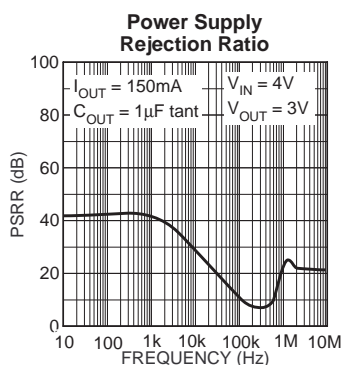
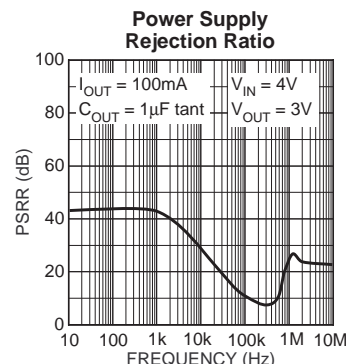
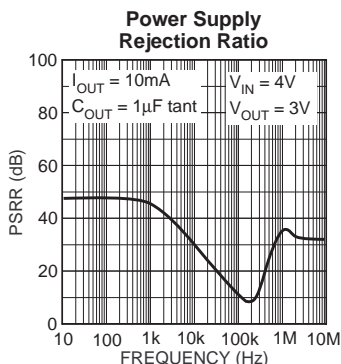
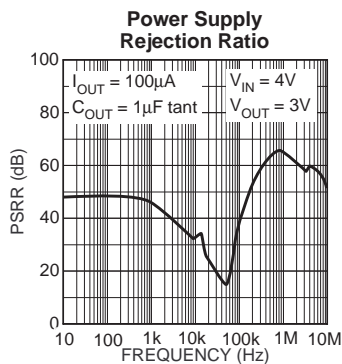

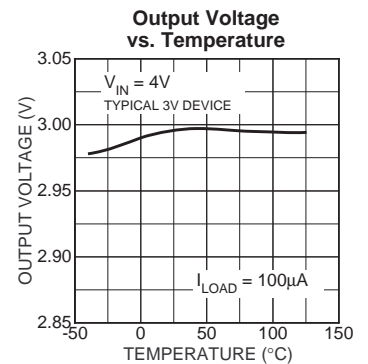
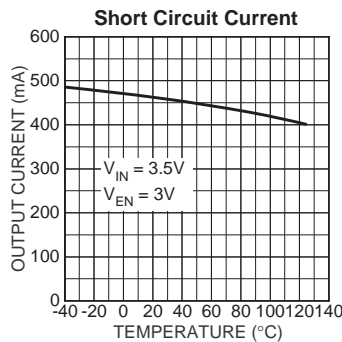
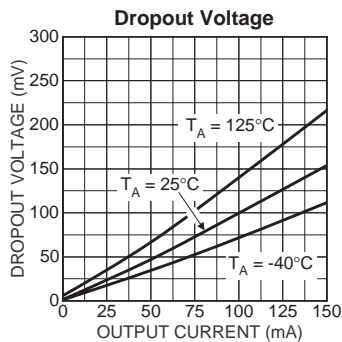
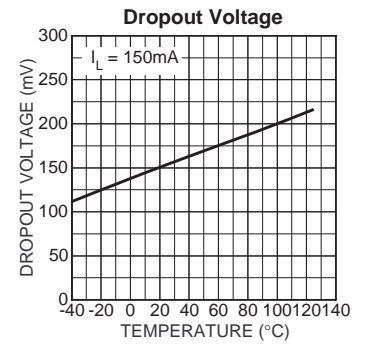
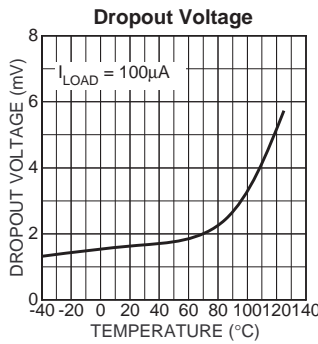
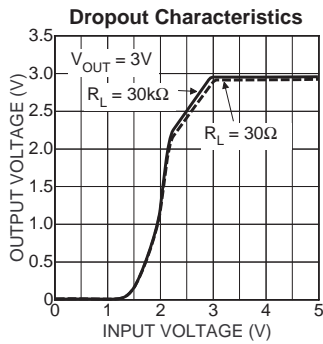
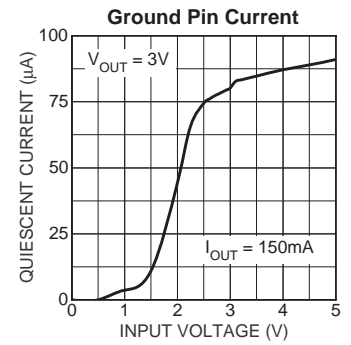
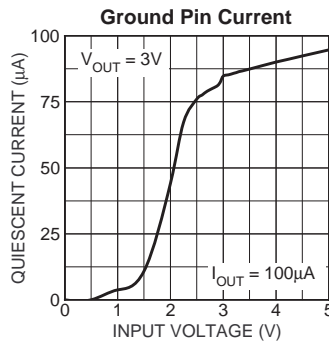
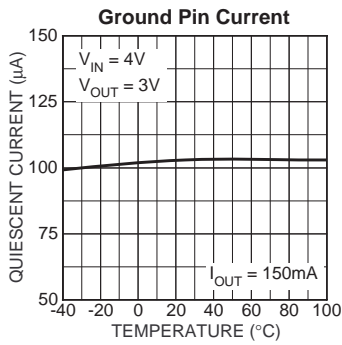
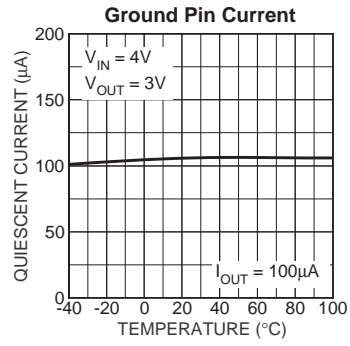
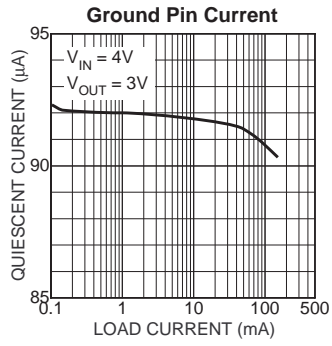

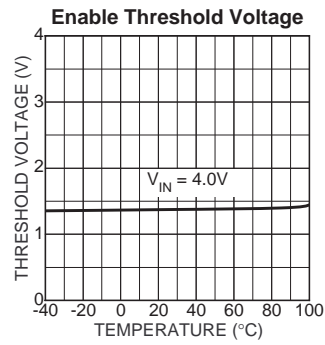
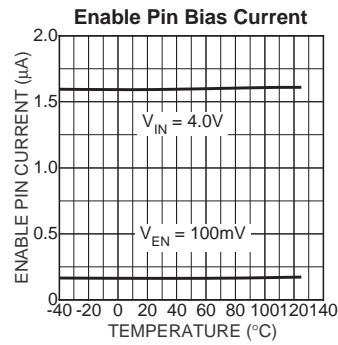

Functional Characteristics

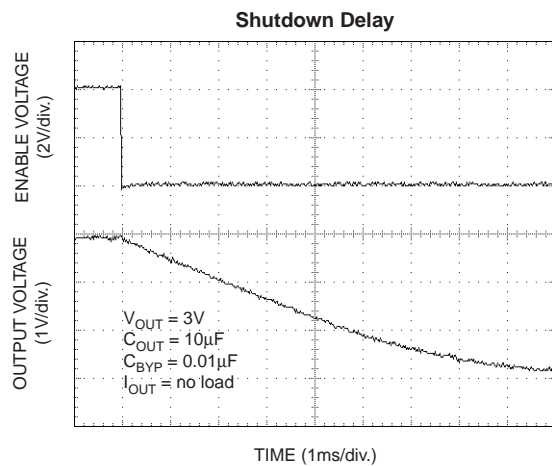
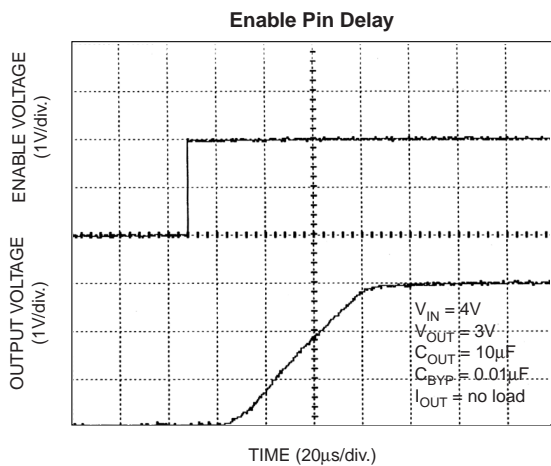
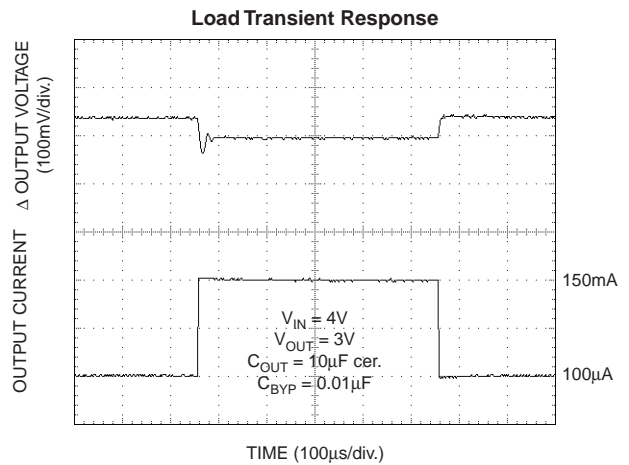
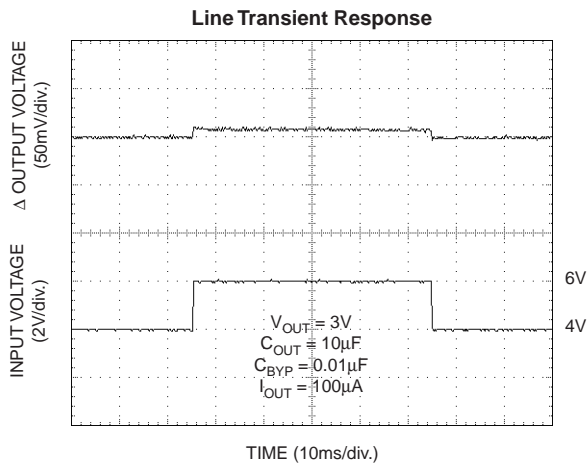

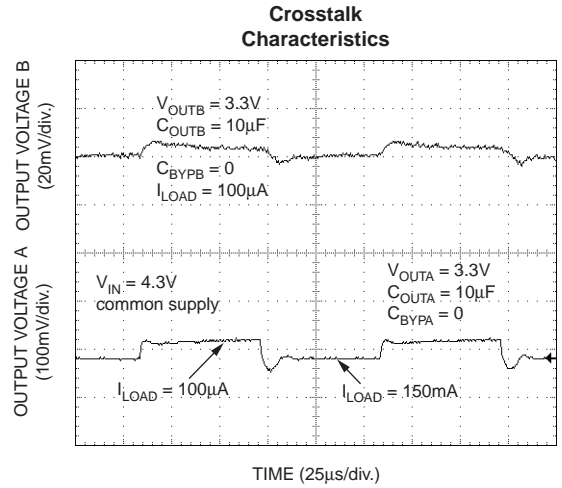
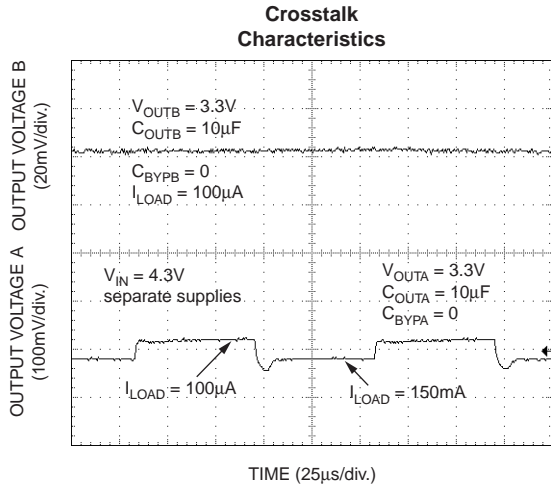

Block Diagrams

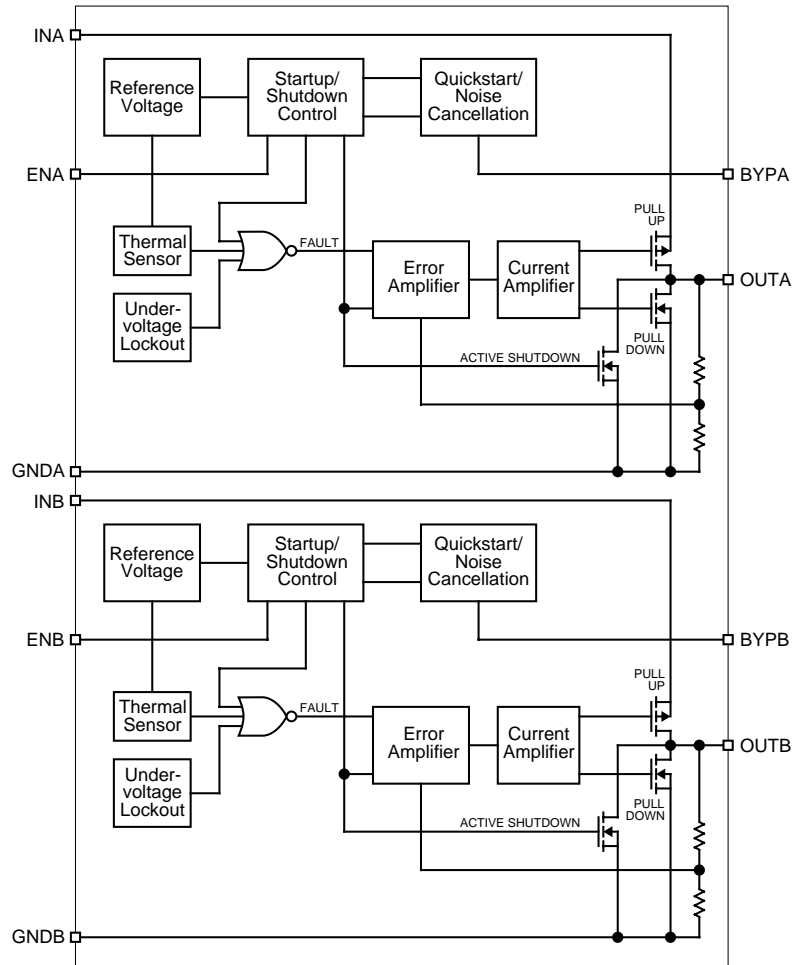

Applications Information

Enable/Shutdown

The MIC5250 comes with active-high enable pins that allows either regulator to be disabled. Forcing an enable pin low disables the respective regulator and places it into a “zero” off-mode-current state. In this state, current consumed by the regulator goes nearly to zero. Forcing an enable pin high enables the output voltage. This part is CMOS therefore the enable pin cannot be left floating; a floating enable pin may cause an indeterminate state on the output.

Input Capacitor

Input capacitors are not required for stability. A 1 μ F input capacitor is recommended for either regulator when the bulk ac supply capacitance is more than 10 inches away from the device, or when the supply is a battery.

Output Capacitor

The MIC5250 requires output capacitors for stability. The design requires 1 μ F or greater on each output to maintain stability. Capacitors can be low-ESR ceramic chip capacitors. The MIC5250 has been designed to work specifically with low-cost, small chip capacitors. Tantalum capacitors can also be used for improved capacitance over the operating temperature range. The value of the capacitor can be increased without bounds.

Bypass Capacitor

Capacitors can be placed from each noise bypass pin to their respective ground to reduce output voltage noise. These capacitors bypass the internal references. A 0.01 μ F capacitor is recommended for applications that require low-noise outputs.

Transient Response

The MIC5250 implements a unique output stage design which dramatically improves transient response recovery time. The output is a totem-pole configuration with a P-channel MOSFET pass device and an N-channel MOSFET clamp. The N-channel clamp is a significantly smaller device that prevents the output voltage from overshooting when a heavy load is removed. This feature helps to speed up the transient response by significantly decreasing transient response recovery time during the transition from heavy load (100mA) to light load (100 μ A).

Active Shutdown

Each regulator also features an active shutdown clamp, which is an N-channel MOSFET that turns on when the device is disabled. This allows the output capacitor and load to discharge, de-energizing the load.

Cross Talk

When a load transient occurs on one output of the MIC5250, the second output may couple a small amount of ripple to its output. This typically comes from a common input source or from poor grounding. Using proper grounding techniques such as star grounding as well as good bypassing directly at the inputs of each regulator will help to reduce the magnitude of the cross talk. See “Functional Characteristics” for an example of cross talk performance.

Thermal Considerations

The MIC5250 is a dual LDO voltage regulator designed to provide two output voltages from one package. Both regulator outputs are capable of sourcing 150mA of output current. Proper thermal evaluation needs to be done to ensure that the junction temperature does not exceed its maximum value, 125°C. Maximum power dissipation can be calculated based on the output current and the voltage drop across each regulator. The sum of the power dissipation of each regulator determines the total power dissipation. The maximum power dissipation that this package is capable of handling can be determined using thermal resistance, junction to ambient, and the following basic equation:

$$P_{D(max)} = \left(\frac{T_{J(max)} - T_A}{\theta_{JA}} \right)$$

$T_{J(max)}$ is the maximum junction temperature of the die, 125°C and T_A is the ambient operating temperature of the die. θ_{JA} is layout dependent. Table 1 shows the typical thermal resistance for a minimum footprint layout for the MIC5250.

Package	θ_{JA} at Recommended Minimum Footprint
MSOP-10	200° C/W

Table 1. Thermal Resistance

The actual power dissipation of each regulator output can be calculated using the following simple equation:

$$P_D = (V_{IN} - V_{OUT}) I_{OUT} + V_{IN} I_{GND}$$

Each regulator contributes power dissipation to the overall power dissipation of the package.

$$P_{D(total)} = P_{D(reg1)} + P_{D(reg2)}$$

Each output is rated for 150mA of output current, but the application may limit the amount of output current based on the total power dissipation and the ambient temperature.

A typical application may call for two 3.0V outputs from a single Li-ion battery input. This input can be as high as 4.2V. When operating at high ambient temperatures, the output current may be limited. When operating at an ambient of 60°C, the maximum power dissipation of the package is calculated as follows:

$$P_{D(max)} = \left(\frac{125^\circ\text{C} - 60^\circ\text{C}}{200^\circ\text{C/W}} \right)$$

$$P_{D(max)} = 325\text{mW}$$

For the application mentioned above, if regulator 1 is sourcing 150mA, it contributes the following to the overall power dissipation:

$$P_{D(reg1)} = (V_{IN} - V_{OUT}) I_{OUT} + V_{IN} I_{GND}$$

$$P_{D(reg1)} = (4.2\text{V} - 3.0\text{V}) 150\text{mA} + 4.2\text{V} \times 100\mu\text{A}$$

$$P_{D(reg1)} = 180.4\text{mW}$$

Since the total power dissipation allowable is 325mW, the maximum power dissipation of the second regulator is limited to:

$$P_{D(max)} = P_{D(reg1)} + P_{D(reg2)}$$

$$325mW = 180.4mW + P_{D(reg2)}$$

$$P_{D(reg2)} = 144.6mW$$

The maximum output current of the second regulator can be calculated using the same equations but solving for the output current (ground current is constant over load and simplifies the equation):

$$P_{D(reg2)} = (V_{IN} - V_{OUT})I_{OUT} + V_{IN} I_{GND}$$

$$144.6mW = (4.2V - 3.0V)I_{OUT} + 4.2V \times 100\mu A$$

$$I_{OUT} = 120.5mA$$

The second output is limited to 120mA due to the total power dissipation of the system when operating at 60°C ambient temperature.

Fixed Regulator Applications

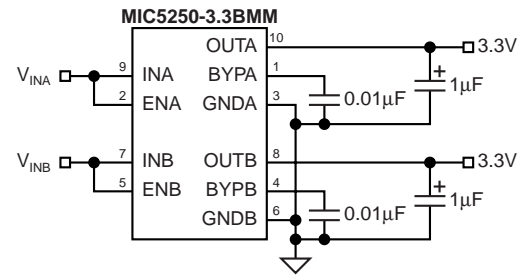

Figure 1. Ultra-Low-Noise Dual 3.3V Application

Figure 1 includes 0.01µF capacitors for low-noise operation and shows EN (pin 3) connected to IN (pin 1) for an applications where enable/shutdown is not required. C_{OUT} = 1µF minimum.

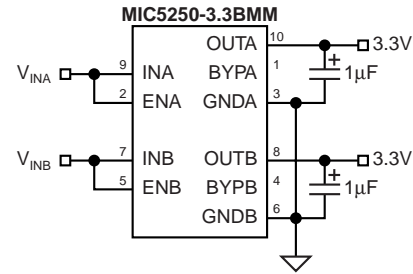

Figure 2. Low-Noise Fixed Voltage Application

Figure 2 is an example of a low-noise configuration where C_{BYP} is not required. C_{OUT} = 1µF minimum.

Dual-Supply Operation

When used in dual supply systems where the regulator load is returned to a negative supply, the output voltage must be diode clamped to ground.

Package Information

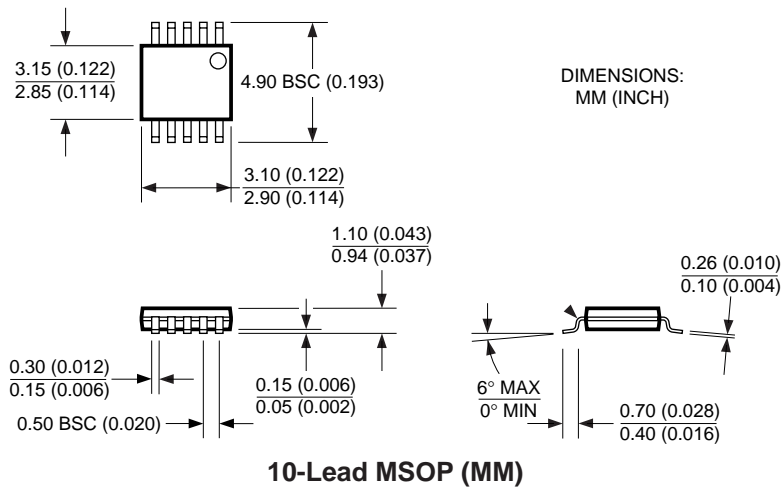

MICREL INC. 1849 FORTUNE DRIVE SAN JOSE, CA 95131 USA

TEL + 1 (408) 944-0800 FAX + 1 (408) 944-0970 WEB <http://www.micrel.com>

This information is believed to be accurate and reliable, however no responsibility is assumed by Micrel for its use nor for any infringement of patents or other rights of third parties resulting from its use. No license is granted by implication or otherwise under any patent or patent right of Micrel Inc.

© 2003 Micrel Incorporated