



## Product Change Notification - SYST-19ZSMO413

**Date:**

23 Apr 2018

**Product Category:**

Depletion Mode MOSFETs

**Affected CPNs:****Notification subject:**

Data Sheet - DN3545 N-Channel Depletion-Mode Vertical DMOS FET Data Sheet

**Notification text:**

SYST-19ZSMO413

Microchip has released a new DeviceDoc for the DN3545 N-Channel Depletion-Mode Vertical DMOS FET Data Sheet of devices. If you are using one of these devices please read the document located at [DN3545 N-Channel Depletion-Mode Vertical DMOS FET Data Sheet](#).

**Notification Status:** Final

**Description of Change:** 1) Converted Supertex doc #DSFP-DN3545 to Microchip DS20005438A 2) Added sections to comply with the standard Microchip format. 3) Changed the package marking format 4) Removed the 3-lead TO-92 N3 P002, P003, P005, P013 and P014 media types 5) Made minor text changes throughout the document.

**Impacts to Data Sheet:** None

**Reason for Change:** To Improve Manufacturability

**Change Implementation Status:** Complete

**Date Document Changes Effective:** 23 April 2018

**NOTE:** Please be advised that this is a change to the document only the product has not been changed.

**Markings to Distinguish Revised from Unrevised Devices:** N/A

**Attachment(s):**

[DN3545 N-Channel Depletion-Mode Vertical DMOS FET Data Sheet](#)

Please contact your local [Microchip sales office](#) with questions or concerns regarding this notification.



**Terms and Conditions:**

If you wish to change your product/process change notification (PCN) profile please log on to our website at <http://www.microchip.com/PCN> sign into myMICROCHIP to open the myMICROCHIP home page, then select a profile option from the left navigation bar.

To opt out of future offer or information emails (other than product change notification emails), click here to go to [microchipDIRECT](#) and login, then click on the "My account" link, click on "Update profile" and un-check the box that states "Future offers or information about Microchip's products or services."

Affected Catalog Part Numbers (CPN)

DN3545N3-G

DN3545N8-G

DN3545N8-G-D561

DN3545ND

DN3545ND-D560

DN3545ND-D561

DN3545NW

DN3545NW-8

## N-Channel Depletion-Mode Vertical DMOS FET

### Features

- High Input Impedance
- Low Input Capacitance
- Fast Switching Speeds
- Low On-Resistance
- Free from Secondary Breakdown
- Low Input and Output Leakage

### Applications

- Normally-On Switches
- Solid-State Relays
- Converters
- Linear Amplifiers
- Constant-Current Sources
- Power Supply Circuits
- Telecommunications

### General Description

The DN3545 Depletion-mode normally-on transistor uses an advanced vertical Diffusion Metal Oxide Semiconductor (DMOS) structure and a well-proven silicon-gate manufacturing process. This combination produces a device with the power-handling capabilities of bipolar transistors and the high-input impedance and positive-temperature coefficient inherent in Metal-Oxide Semiconductor (MOS) devices. Characteristic of all MOS structures, this device is free from thermal runaway and thermally induced secondary breakdown.

Vertical DMOS Field-Effect Transistors (FETs) are ideally suited to a wide range of switching and amplifying applications where very low threshold voltage, high breakdown voltage, high input impedance, low input capacitance and fast switching speeds are desired.

### Package Types

**3-lead TO-92**  
(Top view)

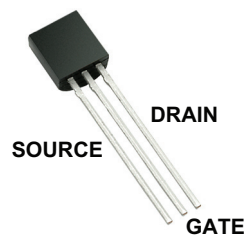

**3-lead SOT-89**  
(Top view)

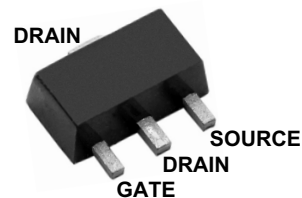

See [Table 3-1](#) and [Table 3-2](#) for pin information.

# DN3545

## 1.0 ELECTRICAL CHARACTERISTICS

### ABSOLUTE MAXIMUM RATINGS†

Drain-to-Source Voltage.....	BV <sub>DSX</sub>
Drain-to-Gate Voltage.....	BV <sub>DGX</sub>
Gate-to-Source Voltage.....	±20V
Operating Ambient Temperature, T <sub>A</sub> .....	-55°C to +150°C
Storage Temperature, T <sub>S</sub> .....	-55°C to +150°C

† **Notice:** Stresses above those listed under “Maximum Ratings” may cause permanent damage to the device. This is a stress rating only and functional operation of the device at those or any other conditions above those indicated in the operational listings of this specification is not implied. Exposure to maximum rating conditions for extended periods may affect device reliability.

### DC ELECTRICAL CHARACTERISTICS

**Electrical Specifications:** T<sub>A</sub> = 25°C unless otherwise specified. All DC parameters are 100% tested at 25°C unless otherwise stated. Pulse test: 300 μs pulse, 2% duty cycle.

Parameter	Sym.	Min.	Typ.	Max.	Unit	Conditions
Drain-to-Source Breakdown Voltage	BV <sub>DSX</sub>	450	—	—	V	V <sub>GS</sub> = -5V, I <sub>D</sub> = 100 μA
Gate-to-Source Off Voltage	V <sub>GS(OFF)</sub>	-1.5	—	-3.5	V	V <sub>DS</sub> = 25V, I <sub>D</sub> = 10 μA
V <sub>GS(OFF)</sub> Change with Temperature	ΔV <sub>GS(OFF)</sub>	—	—	-4.5	mV/°C	V <sub>DS</sub> = 25V, I <sub>D</sub> = 10 μA ( <b>Note 1</b> )
Gate Body Leakage Current	I <sub>GSS</sub>	—	—	100	nA	V <sub>GS</sub> = ±20V, V <sub>DS</sub> = 0V
Drain-to-Source Leakage Current	I <sub>D(OFF)</sub>	—	—	1	μA	V <sub>DS</sub> = Maximum rating, V <sub>GS</sub> = -5V
		—	—	1	mA	V <sub>DS</sub> = 0.8 Maximum rating, V <sub>GS</sub> = -5V, T <sub>A</sub> = 125°C ( <b>Note 1</b> )
Saturated Drain-to-Source Current	I <sub>DSS</sub>	200	—	—	mA	V <sub>GS</sub> = 0V, V <sub>DS</sub> = 15V
Static Drain-to-Source On-State Resistance	R <sub>DS(ON)</sub>	—	—	20	Ω	V <sub>GS</sub> = 0V, I <sub>D</sub> = 150 mA
Change in R <sub>DS(ON)</sub> with Temperature	ΔR <sub>DS(ON)</sub>	—	—	1.1	%/°C	V <sub>GS</sub> = 0V, I <sub>D</sub> = 150 mA ( <b>Note 1</b> )

**Note 1:** Specification is obtained by characterization and is not 100% tested.

### AC ELECTRICAL CHARACTERISTICS

**Electrical Specifications:** Unless otherwise specified, for all specifications T<sub>A</sub> = 25°C. Specification is obtained by characterization and is not 100% tested.

Parameter	Sym.	Min.	Typ.	Max.	Unit	Conditions
Forward Transconductance	G <sub>FS</sub>	150	—	—	mmho	V <sub>DS</sub> = 10V, I <sub>D</sub> = 100 mA
Input Capacitance	C <sub>ISS</sub>	—	—	360	pF	V <sub>GS</sub> = -5V, V <sub>DS</sub> = 25V, f = 1 MHz
Common Source Output Capacitance	C <sub>OSS</sub>	—	—	40	pF	
Reverse Transfer Capacitance	C <sub>RSS</sub>	—	—	15	pF	
Turn-On Delay Time	t <sub>d(ON)</sub>	—	—	20	ns	V <sub>DD</sub> = 25V, I <sub>D</sub> = 150 mA, R <sub>GEN</sub> = 25Ω, V <sub>GS</sub> = 0V to -10V
Rise Time	t <sub>r</sub>	—	—	30	ns	
Turn-Off Delay Time	t <sub>d(OFF)</sub>	—	—	30	ns	
Fall Time	t <sub>f</sub>	—	—	40	ns	

#### DIODE PARAMETER

Diode Forward Voltage Drop	V <sub>SD</sub>	—	—	1.8	V	V <sub>GS</sub> = -5V, I <sub>SD</sub> = 150 mA ( <b>Note 1</b> )
Reverse Recovery Time	t <sub>rr</sub>	—	800	—	ns	V <sub>GS</sub> = -5V, I <sub>SD</sub> = 150 mA

**Note 1:** All DC parameters are 100% tested at 25°C unless otherwise stated. Pulse test: 300 μs pulse, 2% duty cycle.

## TEMPERATURE SPECIFICATIONS

Electrical Specifications: Unless otherwise specified, for all specifications $T_A = T_J = +25^{\circ}\text{C}$ .						
Parameter	Sym.	Min.	Typ.	Max.	Unit	Conditions
<b>TEMPERATURE RANGE</b>						
Operating Ambient Temperature	$T_A$	-55	—	150	$^{\circ}\text{C}$	
Storage Temperature	$T_S$	-55	—	150	$^{\circ}\text{C}$	
<b>PACKAGE THERMAL RESISTANCE</b>						
3-lead TO-92	$\theta_{JA}$	—	132	—	$^{\circ}\text{C}/\text{W}$	
3-lead SOT-89	$\theta_{JA}$	—	133	—	$^{\circ}\text{C}/\text{W}$	

## THERMAL CHARACTERISTICS

Package	$I_D$ (Note 1) Continuous (mA)	$I_D$ Pulsed (mA)	Power Dissipation at $T_C = 25^{\circ}\text{C}$ (W)	$I_{DR}$ (Note 1) (mA)	$I_{DRM}$ (mA)
3-lead TO-92	136	1600	0.74	136	1600
3-lead SOT-89	200	300	1.6 (Note 2)	200	300

**Note 1:**  $I_D$  continuous is limited by the maximum rated  $T_J$ .

**Note 2:** Mounted on an FR4 board, 25 mm x 25 mm x 1.57 mm

## 2.0 TYPICAL PERFORMANCE CURVES

**Note:** The graphs and tables provided following this note are a statistical summary based on a limited number of samples and are provided for informational purposes only. The performance characteristics listed herein are not tested or guaranteed. In some graphs or tables, the data presented may be outside the specified operating range (e.g. outside specified power supply range) and therefore outside the warranted range.

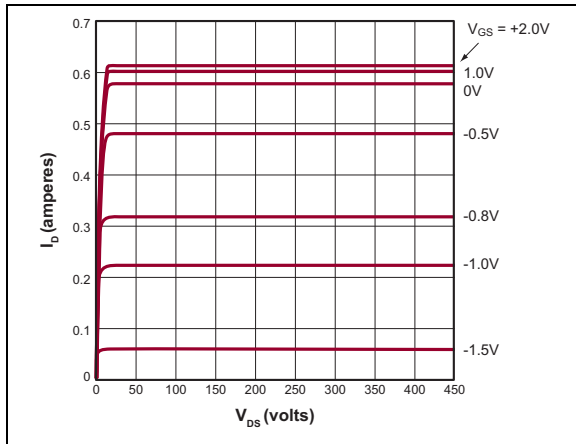

**FIGURE 2-1:** Output Characteristics.

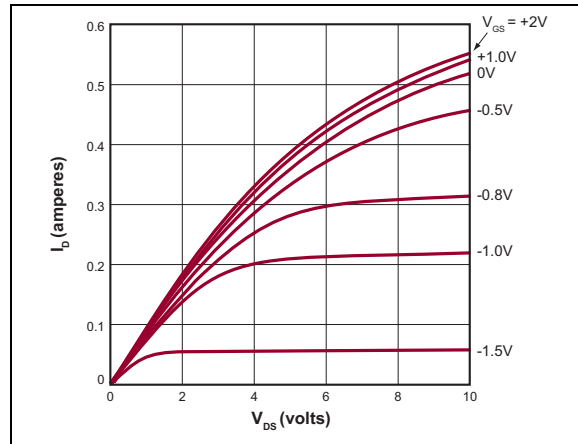

**FIGURE 2-4:** Saturation Characteristics.

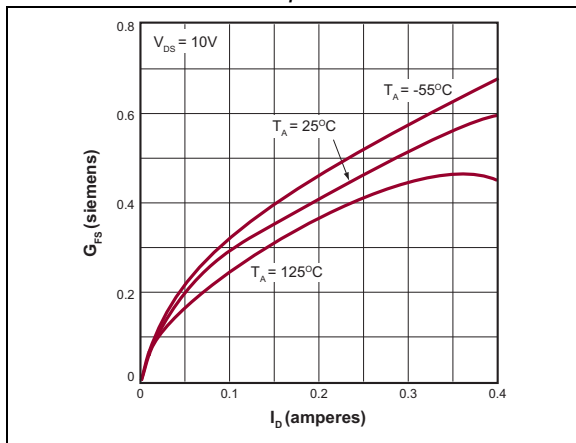

**FIGURE 2-2:** Transconductance vs. Drain Current.

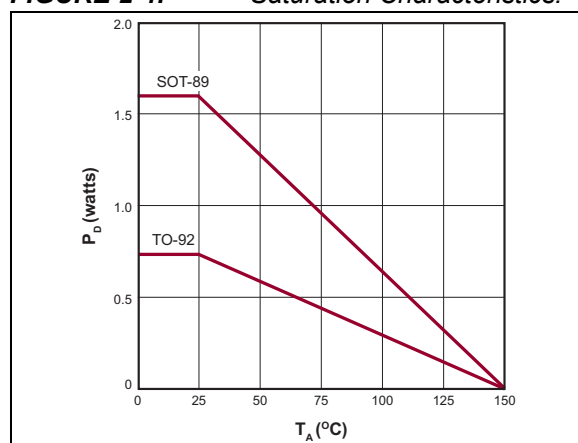

**FIGURE 2-5:** Power Dissipation vs. Ambient Temperature.

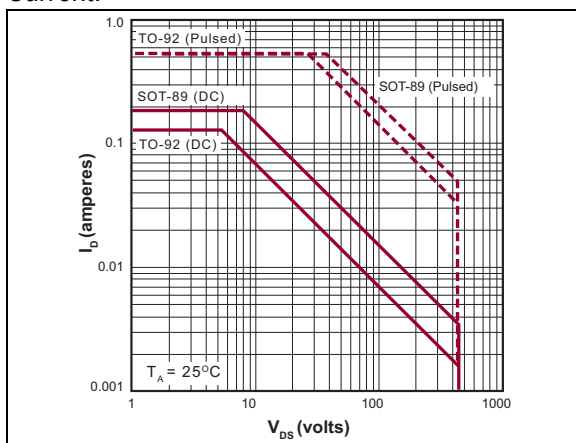

**FIGURE 2-3:** Maximum Rated Safe Operating Area.

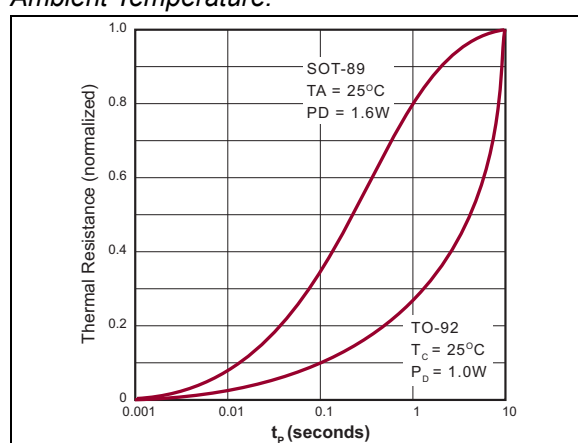

**FIGURE 2-6:** Thermal Response Characteristics.

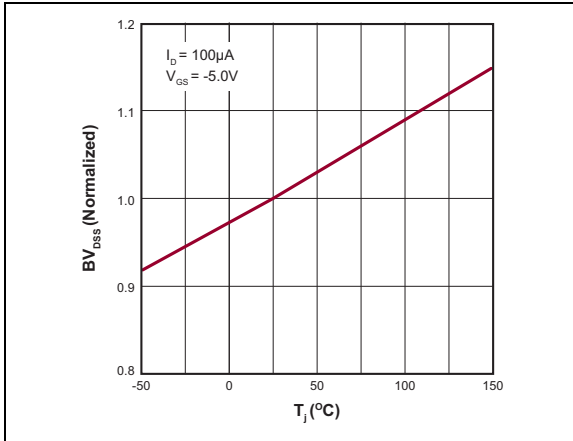

**FIGURE 2-7:**  $BV_{DSS}$  Variation with Temperature.

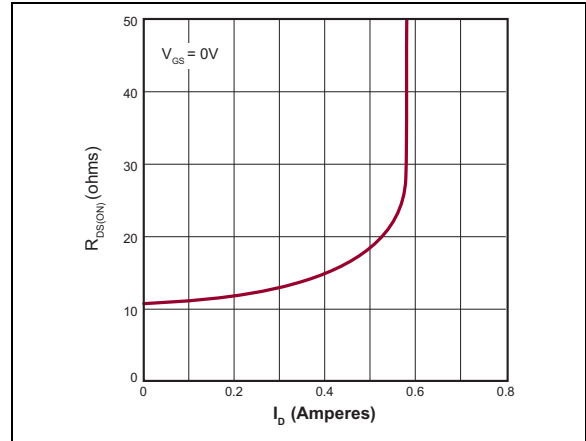

**FIGURE 2-10:** On-Resistance vs. Drain Current.

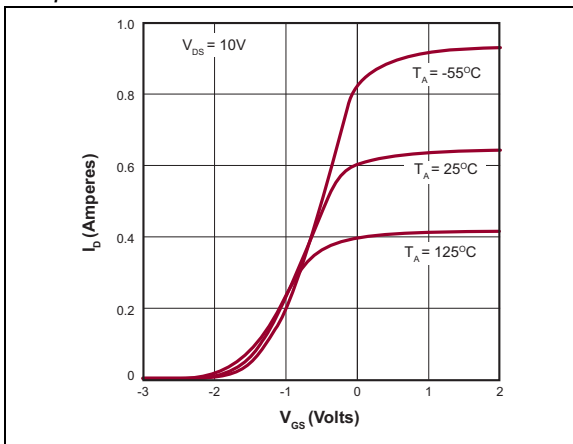

**FIGURE 2-8:** Transfer Characteristics.

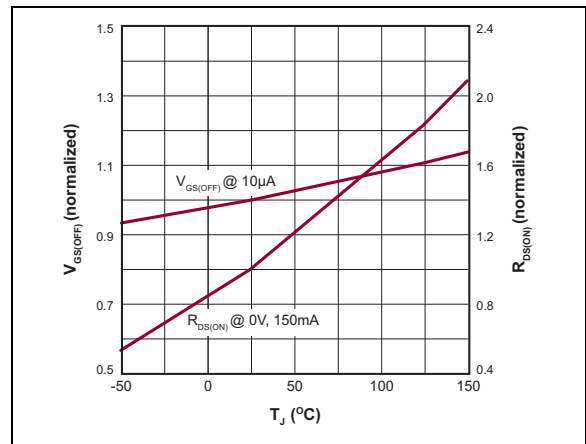

**FIGURE 2-11:**  $V_{GS(th)}$  and  $R_{DS(ON)}$  Variation with Temperature.

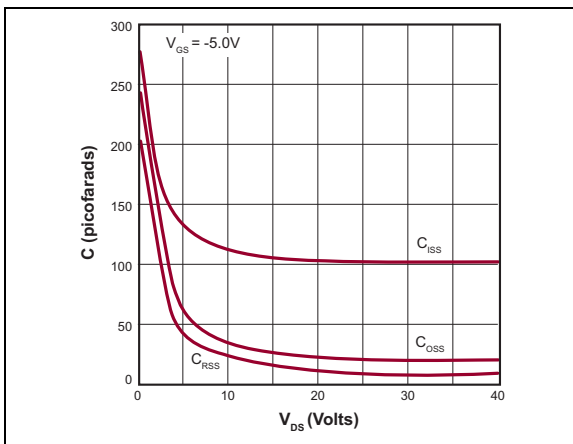

**FIGURE 2-9:** Capacitance vs. Drain-to-Source Voltage.

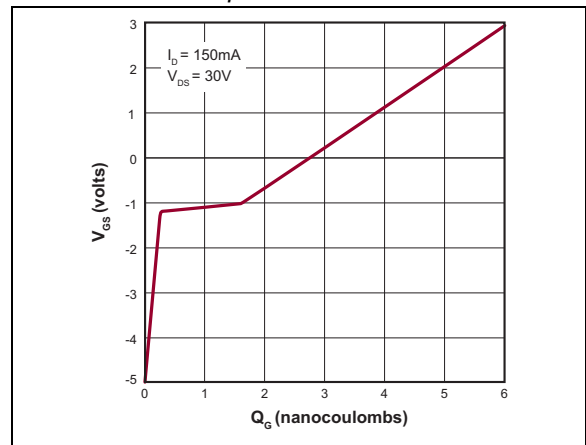

**FIGURE 2-12:** Gate Drive Dynamic Characteristics.



# DN3545

---

## 3.0 PIN DESCRIPTION

The details on the pins of 3-lead TO-92 and 3-lead SOT-89 packages are listed on [Table 3-1](#) and [Table 3-2](#), respectively. The locations of pins are indicated in [Package Types](#).

**TABLE 3-1: 3-LEAD TO-92 PIN FUNCTION TABLE**

Pin Number	Pin Name	Description
1	Source	Source
2	Gate	Gate
3	Drain	Drain

**TABLE 3-2: 3-LEAD SOT-89 PIN FUNCTION TABLE**

Pin Number	Pin Name	Description
1	Gate	Gate
2, 4	Drain	Drain
3	Source	Source

## 4.0 FUNCTIONAL DESCRIPTION

Figure 4-1 illustrates the switching waveforms and test circuit for DN3545.

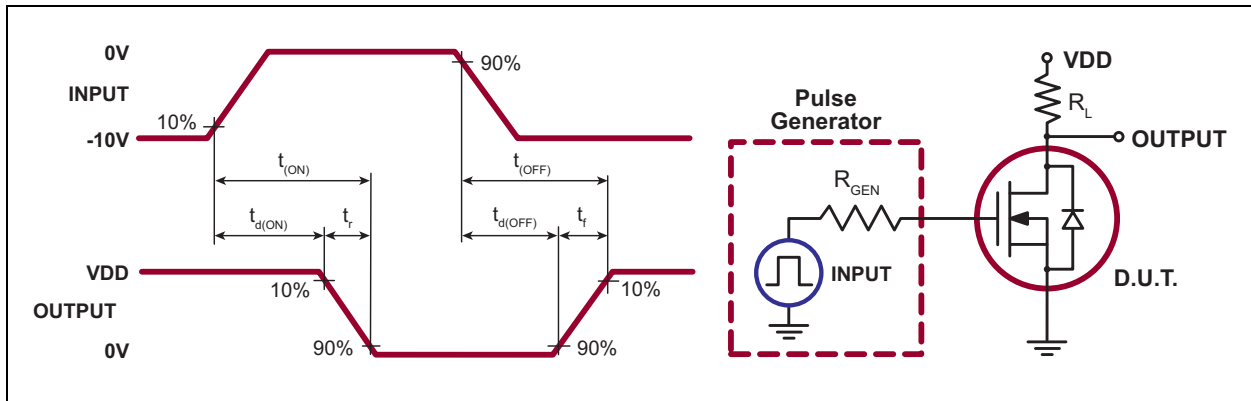

**FIGURE 4-1:** Switching Waveforms and Test Circuit.

**TABLE 4-1: PRODUCT SUMMARY**

$BV_{DSX}/BV_{DGX}$ (V)	$R_{DS(ON)}$ (Maximum) ( $\Omega$ )	$I_{DSS}$ (Minimum) (mA)
450	20	200

# DN3545

## 5.0 PACKAGING INFORMATION

### 5.1 Package Marking Information

3-lead TO-92

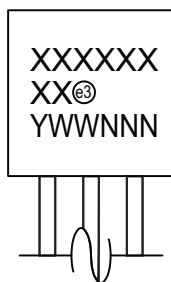

Example

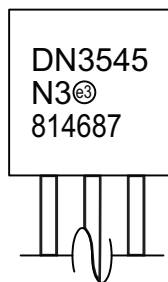

3-lead TO-243AA

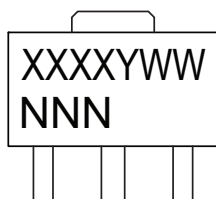

Example

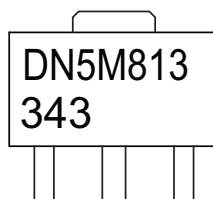

<b>Legend:</b>	XX...X	Product Code or Customer-specific information
	Y	Year code (last digit of calendar year)
	YY	Year code (last 2 digits of calendar year)
	WW	Week code (week of January 1 is week '01')
	NNN	Alphanumeric traceability code
	ⓔ	Pb-free JEDEC <sup>®</sup> designator for Matte Tin (Sn)
	*	This package is Pb-free. The Pb-free JEDEC designator (ⓔ) can be found on the outer packaging for this package.

**Note:** In the event the full Microchip part number cannot be marked on one line, it will be carried over to the next line, thus limiting the number of available characters for product code or customer-specific information. Package may or not include the corporate logo.

## 3-Lead TO-92 Package Outline (L/LL/N3)

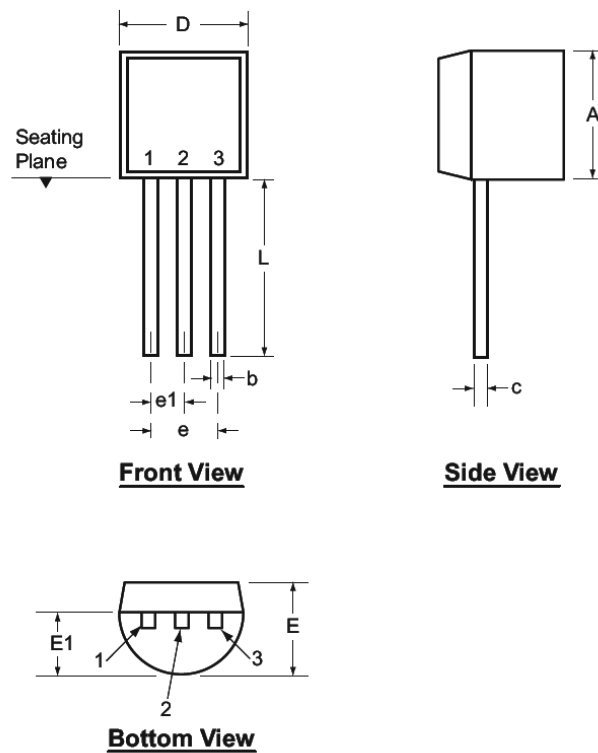

Note: For the most current package drawings, see the Microchip Packaging Specification at [www.microchip.com/packaging](http://www.microchip.com/packaging).

Symbol	A	b	c	D	E	E1	e	e1	L	
Dimensions (inches)	MIN	.170	.014 <sup>†</sup>	.014 <sup>†</sup>	.175	.125	.080	.095	.045	.500
	NOM	-	-	-	-	-	-	-	-	-
	MAX	.210	.022 <sup>†</sup>	.022 <sup>†</sup>	.205	.165	.105	.105	.055	.610*

JEDEC Registration TO-92.

\* This dimension is not specified in the JEDEC drawing.

† This dimension differs from the JEDEC drawing.

Drawings not to scale.

## 3-Lead TO-243AA (SOT-89) Package Outline (N8)

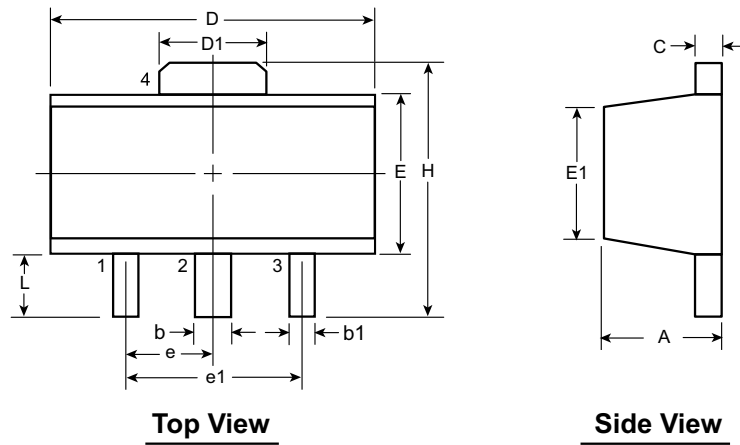

Note: For the most current package drawings, see the Microchip Packaging Specification at [www.microchip.com/packaging](http://www.microchip.com/packaging).

Symbol	A	b	b1	C	D	D1	E	E1	e	e1	H	L		
Dimensions (mm)	MIN	1.40	0.44	0.36	0.35	4.40	1.62	2.29	2.00 <sup>†</sup>	1.50 BSC	3.00 BSC	3.94	0.73 <sup>†</sup>	
	NOM	-	-	-	-	-	-	-	-			-	-	-
	MAX	1.60	0.56	0.48	0.44	4.60	1.83	2.60	2.29			4.25	1.20	

JEDEC Registration TO-243, Variation AA, Issue C, July 1986.

<sup>†</sup> This dimension differs from the JEDEC drawing

Drawings not to scale.

## APPENDIX A: REVISION HISTORY

### Revision A (April 2018)

- Converted Supertex doc #DSFP-DN3545 to Microchip DS20005438A
- Added sections to comply with the standard Microchip format
- Changed the package marking format
- Removed the 3-lead TO-92 N3 P002, P003, P005, P013 and P014 media types
- Made minor text changes throughout the document

# DN3545

## PRODUCT IDENTIFICATION SYSTEM

To order or obtain information, e.g., on pricing or delivery, contact your local Microchip representative or sales office.

<u>PART NO.</u>	<u>XX</u>	-	<u>X</u>	-	<u>X</u>
Device	Package Options		Environmental		Media Type
Device:	DN3545	=	N-Channel Depletion-Mode Vertical DMOS FET		
Packages:	N3	=	3-lead TO-92		
	N8	=	3-lead SOT-89		
Environmental:	G	=	Lead (Pb)-free/RoHS-compliant Package		
Media Types:	(blank)	=	1000/Bag for an N3 Package		
	(blank)	=	2000/Reel for an N8 Package		

**Examples:**

a) DN3545N3-G: N-Channel Depletion-Mode Vertical DMOS FET, 3-lead TO-92, 1000/Bag

b) DN3545N8-G: N-Channel Depletion-Mode Vertical DMOS FET, 3-lead SOT-89, 2000/Reel

---

---

**Note the following details of the code protection feature on Microchip devices:**

- Microchip products meet the specification contained in their particular Microchip Data Sheet.
- Microchip believes that its family of products is one of the most secure families of its kind on the market today, when used in the intended manner and under normal conditions.
- There are dishonest and possibly illegal methods used to breach the code protection feature. All of these methods, to our knowledge, require using the Microchip products in a manner outside the operating specifications contained in Microchip's Data Sheets. Most likely, the person doing so is engaged in theft of intellectual property.
- Microchip is willing to work with the customer who is concerned about the integrity of their code.
- Neither Microchip nor any other semiconductor manufacturer can guarantee the security of their code. Code protection does not mean that we are guaranteeing the product as “unbreakable.”

Code protection is constantly evolving. We at Microchip are committed to continuously improving the code protection features of our products. Attempts to break Microchip's code protection feature may be a violation of the Digital Millennium Copyright Act. If such acts allow unauthorized access to your software or other copyrighted work, you may have a right to sue for relief under that Act.

---

Information contained in this publication regarding device applications and the like is provided only for your convenience and may be superseded by updates. It is your responsibility to ensure that your application meets with your specifications. MICROCHIP MAKES NO REPRESENTATIONS OR WARRANTIES OF ANY KIND WHETHER EXPRESS OR IMPLIED, WRITTEN OR ORAL, STATUTORY OR OTHERWISE, RELATED TO THE INFORMATION, INCLUDING BUT NOT LIMITED TO ITS CONDITION, QUALITY, PERFORMANCE, MERCHANTABILITY OR FITNESS FOR PURPOSE. Microchip disclaims all liability arising from this information and its use. Use of Microchip devices in life support and/or safety applications is entirely at the buyer's risk, and the buyer agrees to defend, indemnify and hold harmless Microchip from any and all damages, claims, suits, or expenses resulting from such use. No licenses are conveyed, implicitly or otherwise, under any Microchip intellectual property rights unless otherwise stated.

*Microchip received ISO/TS-16949:2009 certification for its worldwide headquarters, design and wafer fabrication facilities in Chandler and Tempe, Arizona; Gresham, Oregon and design centers in California and India. The Company's quality system processes and procedures are for its PIC® MCUs and dsPIC® DSCs, KEELOQ® code hopping devices, Serial EEPROMs, microperipherals, nonvolatile memory and analog products. In addition, Microchip's quality system for the design and manufacture of development systems is ISO 9001:2000 certified.*

**QUALITY MANAGEMENT SYSTEM  
CERTIFIED BY DNV  
= ISO/TS 16949 =**

### Trademarks

The Microchip name and logo, the Microchip logo, AnyRate, AVR, AVR logo, AVR Freaks, BeaconThings, BitCloud, CryptoMemory, CryptoRF, dsPIC, FlashFlex, flexPWR, Heldo, JukeBlox, KEELOQ, KEELOQ logo, Klear, LANCheck, LINK MD, maXStylus, maXTouch, MediaLB, megaAVR, MOST, MOST logo, MPLAB, OptoLyzer, PIC, picoPower, PICSTART, PIC32 logo, Prochip Designer, QTouch, RightTouch, SAM-BA, SpyNIC, SST, SST Logo, SuperFlash, tinyAVR, UNI/O, and XMEGA are registered trademarks of Microchip Technology Incorporated in the U.S.A. and other countries.

ClockWorks, The Embedded Control Solutions Company, EtherSynch, Hyper Speed Control, HyperLight Load, IntelliMOS, mTouch, Precision Edge, and Quiet-Wire are registered trademarks of Microchip Technology Incorporated in the U.S.A.

Adjacent Key Suppression, AKS, Analog-for-the-Digital Age, Any Capacitor, AnyIn, AnyOut, BodyCom, chipKIT, chipKIT logo, CodeGuard, CryptoAuthentication, CryptoCompanion, CryptoController, dsPICDEM, dsPICDEM.net, Dynamic Average Matching, DAM, ECAN, EtherGREEN, In-Circuit Serial Programming, ICSP, Inter-Chip Connectivity, JitterBlocker, KlearNet, KlearNet logo, Mindi, MiWi, motorBench, MPASM, MPF, MPLAB Certified logo, MPLIB, MPLINK, MultiTRAK, NetDetach, Omniscient Code Generation, PICDEM, PICDEM.net, PICKit, PICTail, PureSilicon, QMatrix, RightTouch logo, REAL ICE, Ripple Blocker, SAM-ICE, Serial Quad I/O, SMART-I.S., SQI, SuperSwitcher, SuperSwitcher II, Total Endurance, TSHARC, USBCheck, VariSense, ViewSpan, WiperLock, Wireless DNA, and ZENA are trademarks of Microchip Technology Incorporated in the U.S.A. and other countries.

SQTP is a service mark of Microchip Technology Incorporated in the U.S.A.

Silicon Storage Technology is a registered trademark of Microchip Technology Inc. in other countries.

GestIC is a registered trademark of Microchip Technology Germany II GmbH & Co. KG, a subsidiary of Microchip Technology Inc., in other countries.

All other trademarks mentioned herein are property of their respective companies.

© 2018, Microchip Technology Incorporated, All Rights Reserved.  
ISBN: 978-1-5224-2936-4





# MICROCHIP

## Worldwide Sales and Service

### AMERICAS

**Corporate Office**  
2355 West Chandler Blvd.  
Chandler, AZ 85224-6199  
Tel: 480-792-7200  
Fax: 480-792-7277  
Technical Support:  
<http://www.microchip.com/support>  
Web Address:  
[www.microchip.com](http://www.microchip.com)

#### Atlanta

Duluth, GA  
Tel: 678-957-9614  
Fax: 678-957-1455

#### Austin, TX

Tel: 512-257-3370

#### Boston

Westborough, MA  
Tel: 774-760-0087  
Fax: 774-760-0088

#### Chicago

Itasca, IL  
Tel: 630-285-0071  
Fax: 630-285-0075

#### Dallas

Addison, TX  
Tel: 972-818-7423  
Fax: 972-818-2924

#### Detroit

Novi, MI  
Tel: 248-848-4000

#### Houston, TX

Tel: 281-894-5983

#### Indianapolis

Noblesville, IN  
Tel: 317-773-8323  
Fax: 317-773-5453  
Tel: 317-536-2380

#### Los Angeles

Mission Viejo, CA  
Tel: 949-462-9523  
Fax: 949-462-9608  
Tel: 951-273-7800

#### Raleigh, NC

Tel: 919-844-7510

#### New York, NY

Tel: 631-435-6000

#### San Jose, CA

Tel: 408-735-9110  
Tel: 408-436-4270

#### Canada - Toronto

Tel: 905-695-1980  
Fax: 905-695-2078

### ASIA/PACIFIC

**Australia - Sydney**  
Tel: 61-2-9868-6733

**China - Beijing**  
Tel: 86-10-8569-7000

**China - Chengdu**  
Tel: 86-28-8665-5511

**China - Chongqing**  
Tel: 86-23-8980-9588

**China - Dongguan**  
Tel: 86-769-8702-9880

**China - Guangzhou**  
Tel: 86-20-8755-8029

**China - Hangzhou**  
Tel: 86-571-8792-8115

**China - Hong Kong SAR**  
Tel: 852-2943-5100

**China - Nanjing**  
Tel: 86-25-8473-2460

**China - Qingdao**  
Tel: 86-532-8502-7355

**China - Shanghai**  
Tel: 86-21-3326-8000

**China - Shenyang**  
Tel: 86-24-2334-2829

**China - Shenzhen**  
Tel: 86-755-8864-2200

**China - Suzhou**  
Tel: 86-186-6233-1526

**China - Wuhan**  
Tel: 86-27-5980-5300

**China - Xian**  
Tel: 86-29-8833-7252

**China - Xiamen**  
Tel: 86-592-2388138

**China - Zhuhai**  
Tel: 86-756-3210040

### ASIA/PACIFIC

**India - Bangalore**  
Tel: 91-80-3090-4444

**India - New Delhi**  
Tel: 91-11-4160-8631

**India - Pune**  
Tel: 91-20-4121-0141

**Japan - Osaka**  
Tel: 81-6-6152-7160

**Japan - Tokyo**  
Tel: 81-3-6880-3770

**Korea - Daegu**  
Tel: 82-53-744-4301

**Korea - Seoul**  
Tel: 82-2-554-7200

**Malaysia - Kuala Lumpur**  
Tel: 60-3-7651-7906

**Malaysia - Penang**  
Tel: 60-4-227-8870

**Philippines - Manila**  
Tel: 63-2-634-9065

**Singapore**  
Tel: 65-6334-8870

**Taiwan - Hsin Chu**  
Tel: 886-3-577-8366

**Taiwan - Kaohsiung**  
Tel: 886-7-213-7830

**Taiwan - Taipei**  
Tel: 886-2-2508-8600

**Thailand - Bangkok**  
Tel: 66-2-694-1351

**Vietnam - Ho Chi Minh**  
Tel: 84-28-5448-2100

### EUROPE

**Austria - Wels**  
Tel: 43-7242-2244-39  
Fax: 43-7242-2244-393

**Denmark - Copenhagen**  
Tel: 45-4450-2828  
Fax: 45-4485-2829

**Finland - Espoo**  
Tel: 358-9-4520-820

**France - Paris**  
Tel: 33-1-69-53-63-20  
Fax: 33-1-69-30-90-79

**Germany - Garching**  
Tel: 49-8931-9700

**Germany - Haan**  
Tel: 49-2129-3766400

**Germany - Heilbronn**  
Tel: 49-7131-67-3636

**Germany - Karlsruhe**  
Tel: 49-721-625370

**Germany - Munich**  
Tel: 49-89-627-144-0  
Fax: 49-89-627-144-44

**Germany - Rosenheim**  
Tel: 49-8031-354-560

**Israel - Ra'anana**  
Tel: 972-9-744-7705

**Italy - Milan**  
Tel: 39-0331-742611  
Fax: 39-0331-466781

**Italy - Padova**  
Tel: 39-049-7625286

**Netherlands - Drunen**  
Tel: 31-416-690399  
Fax: 31-416-690340

**Norway - Trondheim**  
Tel: 47-7289-7561

**Poland - Warsaw**  
Tel: 48-22-3325737

**Romania - Bucharest**  
Tel: 40-21-407-87-50

**Spain - Madrid**  
Tel: 34-91-708-08-90  
Fax: 34-91-708-08-91

**Sweden - Gothenberg**  
Tel: 46-31-704-60-40

**Sweden - Stockholm**  
Tel: 46-8-5090-4654

**UK - Wokingham**  
Tel: 44-118-921-5800  
Fax: 44-118-921-5820