



Dual, 10-Bit, Programmable, 30mA High-Output-Current DAC

General Description

The MAX5550 dual, 10-bit, digital-to-analog converter (DAC) features high-output-current capability. The MAX5550 sources up to 30mA per DAC, making it ideal for PIN diode biasing applications. Outputs can also be paralleled for high-current applications (up to 60mA typ). Operating from a single +2.7V to +5.25V supply, the MAX5550 typically consumes 1.5mA per DAC in normal operation and less than 1 μ A (max) in shutdown mode. The MAX5550 also features low output leakage current in shutdown mode ($\pm 1\mu$ A max) that is essential to ensure that the external PIN diodes are off.

Additional features include an integrated +1.25V bandgap reference, and a control amplifier to ensure high accuracy and low-noise performance. A separate reference input (REFIN) allows for the use of an external reference source, such as the MAX6126, for improved gain accuracy. A pin-selectable I²C*/SPI™-compatible serial interface provides optimum flexibility for the MAX5550. The maximum programmable output current value is set using software and an adjustment resistor.

The MAX5550 is available in a (3mm x 3mm) 16-pin thin QFN package, and is specified over the extended (-40°C to +85°C) temperature range.

Applications

PIN Diode Biasing
RF Attenuator Control
VCO Tuning

*Purchase of I²C components from Maxim Integrated Products, Inc., or one of its sublicensed Associated Companies, conveys a license under the Philips I²C Patent Rights to use these components in an I²C system, provided that the system conforms to the I²C Standard Specification as defined by Philips.

SPI is a trademark of Motorola, Inc.

Pin Configuration appears at end of data sheet.

Features

- ◆ Pin-Selectable I²C- or SPI-Compatible Interface
- ◆ Guaranteed Low Output Leakage Current in Shutdown ($\pm 1\mu$ A max)
- ◆ Guaranteed Monotonic over Extended Temperature Range
- ◆ Dual Outputs for Balanced Systems
- ◆ Current Outputs Source Up to 30mA per DAC
- ◆ Parallelable Outputs for 60mA Applications
- ◆ Output Stable with RF Filters
- ◆ Internal or External Reference Capability
- ◆ Digital Output (DOUT) Available for Daisy Chaining in SPI Mode
- ◆ +2.7V to +5.25V Single-Supply Operation
- ◆ 16-Pin (3mm x 3mm) Thin QFN Package
- ◆ Programmable Output Current Range Set by Software and Adjustment Resistor

Ordering Information

PART	PIN-PACKAGE	PKG CODE	TOP MARK
MAX5550ETE	16 Thin QFN-EP*	T1633F-3	ACZ

*EP = Exposed paddle.

Note: Device is specified over the -40°C to +85°C operating range.

Functional Diagram

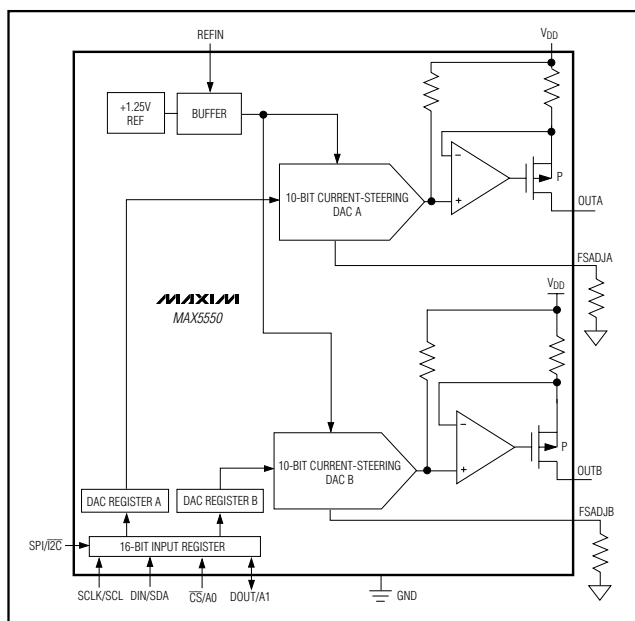

MAX5550



Maxim Integrated Products 1

For pricing, delivery, and ordering information, please contact Maxim/Dallas Direct! at 1-888-629-4642, or visit Maxim's website at www.maxim-ic.com.

Dual, 10-Bit, Programmable, 30mA High-Output-Current DAC

ABSOLUTE MAXIMUM RATINGS

V _{DD} to GND	-0.3V to +6V
OUTA, OUTB to GND	-0.3V to (V _{DD} + 0.3V)
REFIN, $\overline{\text{CS}}$ /AO, DOUT/AI, SPI/I ² C, FSADJA, FSADJB to GND	-0.3V to (V _{DD} + 0.3V)
SCLK/SCL, DIN/SDA	-0.3V to +6V
Continuous Power Dissipation (T _A = +85°C) 16-Pin Thin QFN (derate 17.5mW/°C above +70°C) ..	1398.6mW

Operating Temperature Range	-40°C to +85°C
Junction Temperature	+150°C
Storage Temperature Range	-65°C to +150°C
Lead Temperature (soldering, 10s)	+300°C

Stresses beyond those listed under "Absolute Maximum Ratings" may cause permanent damage to the device. These are stress ratings only, and functional operation of the device at these or any other conditions beyond those indicated in the operational sections of the specifications is not implied. Exposure to absolute maximum rating conditions for extended periods may affect device reliability.

ELECTRICAL CHARACTERISTICS

(V_{DD} = +2.7V to +5.25V, GND = 0, V_{REFIN} = +1.25V, internal reference, R_{FSADJ_} = 20k Ω ; compliance voltage = (V_{DD} - 0.6V), V_{SCLK/SCL} = 0, T_A = -40°C to +85°C, unless otherwise noted. Typical values are at V_{DD} = +3.0V and T_A = +25°C.) (Note 1)

PARAMETER	SYMBOL	CONDITIONS	MIN	TYP	MAX	UNITS
STATIC PERFORMANCE—ANALOG SECTION						
Resolution			10			Bits
Integral Nonlinearity	INL	I _{OUT_} = 1mA to 30mA (Note 2)		± 2		LSB
Differential Nonlinearity	DNL	Guaranteed monotonic			± 1	LSB
Offset	I _{OS}		-50	-16		LSB
Zero-Scale Error		I _{OUT_} = 1mA to 30mA, code = 0x000			1	μ A
Full-Scale Error		I _{OUT_} = 1mA to 30mA, code = 0x3FF, includes offset		-16		LSB
REFERENCE						
Internal Reference Range			1.21	1.25	1.29	V
Internal Reference Tempco				30		ppm/°C
External Reference Range			0.5		1.5	V
External Reference Input Current				108	225	μ A
DAC OUTPUTS						
Full-Scale Current		(Note 3)	1		30	mA
Output Current Leakage in Shutdown					± 1	μ A
Output Capacitance				10		pF
Current Source Dropout Voltage (V _{DD} - V _{OUT_})		I _{OUT_} = 30mA	1		V	
		I _{OUT_} = 20mA	T _A = +25°C			0.55
			T _A = -40°C to +85°C			0.6
Output Impedance at Full-Scale Current				100		k Ω
Capacitive Load to Ground	C _{LOAD}			10		nF
Series Inductive Load	L _{LOAD}			100		nH
Maximum FSADJ_ Capacitive Load	C _{FSADJ_}			75		pF
DYNAMIC PERFORMANCE						
Settling Time	t _s	C _{LOAD} = 24pF, L _{LOAD} = 27nH (Note 4)		30		μ s
Digital Feedthrough				2		nVs

Dual, 10-Bit, Programmable, 30mA High-Output-Current DAC

MAX5550

ELECTRICAL CHARACTERISTICS (continued)

($V_{DD} = +2.7V$ to $+5.25V$, $GND = 0$, $V_{REFIN} = +1.25V$, internal reference, $R_{FSADJ_} = 20k\Omega$; compliance voltage = $(V_{DD} - 0.6V)$, $V_{SCLK/SCL} = 0$, $T_A = -40^\circ C$ to $+85^\circ C$, unless otherwise noted. Typical values are at $V_{DD} = +3.0V$ and $T_A = +25^\circ C$.) (Note 1)

PARAMETER	SYMBOL	CONDITIONS	MIN	TYP	MAX	UNITS
Digital-to-Analog Glitch Impulse				40		nVs
DAC-to-DAC Current Matching				2		%
Wake-Up Time		$V_{DD} = +3V$		400		μs
		$V_{DD} = +5V$		10		
POWER SUPPLIES						
Supply Voltage	V_{DD}		+2.70		+5.25	V
Supply Current	I_{DD}	$V_{DD} = +5.25V$, no load		3	6	mA
Shutdown Current					1.2	μA
LOGIC AND CONTROL INPUTS						
Input High Voltage (Note 5)	V_{IH}	$+2.7V \leq V_{DD} \leq +3.4V$		$0.7 \times V_{DD}$		V
		$+3.4V < V_{DD} \leq +5.25V$		2.4		
Input Low Voltage	V_{IL}	(Note 5)			0.8	V
Input Hysteresis	V_{HYS}			$0.1 \times V_{DD}$		V
Input Capacitance	C_{IN}			10		pF
Input Leakage Current	I_{IN}				± 1	μA
Output Low Voltage	V_{OL}	$I_{SINK} = 3mA$			0.6	V
Output High Voltage	V_{OH}	$I_{SOURCE} = 2mA$		$V_{DD} - 0.5$		V
I²C TIMING CHARACTERISTICS (Figure 2)						
SCL Clock Frequency	f_{SCL}				400	kHz
Setup Time for START Condition	$t_{SU:STA}$		600			ns
Hold Time for START Condition	$t_{HD:STA}$		600			ns
SCL Pulse-Width Low	t_{LOW}		130			ns
SCL Pulse-Width High	t_{HIGH}		600			ns
Data Setup Time	$t_{SU:DAT}$		100			ns
Data Hold Time	$t_{HD:DAT}$		0		70	ns
SCL Rise Time	t_{RCL}		$20 + 0.1 \times C_B$		300	ns
SCL Fall Time	t_{FCL}		$20 + 0.1 \times C_B$		300	ns
SDA Rise Time	t_{RDA}		$20 + 0.1 \times C_B$		300	ns
SDA Fall Time	t_{FDA}		$20 + 0.1 \times C_B$		300	ns

Dual, 10-Bit, Programmable, 30mA High-Output-Current DAC

ELECTRICAL CHARACTERISTICS (continued)

($V_{DD} = +2.7V$ to $+5.25V$, $GND = 0$, $V_{REFIN} = +1.25V$, internal reference, $R_{FSADJ_} = 20k\Omega$; compliance voltage = $(V_{DD} - 0.6V)$, $V_{SCLK/SCL} = 0$, $T_A = -40^\circ C$ to $+85^\circ C$, unless otherwise noted. Typical values are at $V_{DD} = +3.0V$ and $T_A = +25^\circ C$.) (Note 1)

PARAMETER	SYMBOL	CONDITIONS	MIN	TYP	MAX	UNITS
Bus Free Time Between a STOP and START Condition	t_{BUF}		1.3			μs
Setup Time for STOP Condition	$t_{SU:STO}$		160			ns
Maximum Capacitive Load for Each Bus Line	C_B			400		pF
SPI TIMING CHARACTERISTICS (Figure 6)						
SCLK Clock Period	t_{CP}		100			ns
SCLK Pulse-Width High	t_{CH}		40			ns
SCLK Pulse-Width Low	t_{CL}		40			ns
\overline{CS} Fall to SCLK Rise Setup Time	t_{CSS}		25			ns
SCLK Rise to \overline{CS} Rise Hold Time	t_{CSH}		50			ns
DIN Setup Time	t_{DS}		40			ns
DIN Hold Time	t_{DH}		0			ns
SCLK Fall to DOUT Transition	t_{DO1}	$C_{LOAD} = 30pF$			40	ns
\overline{CS} Fall to DOUT Enable	t_{CSE}	$C_{LOAD} = 30pF$			40	ns
\overline{CS} Rise to DOUT Disable	t_{CSD}	$C_{LOAD} = 30pF$			40	ns
SCLK Rise to \overline{CS} Fall Delay	t_{CS0}		50			ns
\overline{CS} Rise to SCLK Rise Hold Time	t_{CS1}		40			ns
\overline{CS} Pulse-Width High	t_{CSW}		100			ns
SPI TIMING CHARACTERISTICS FOR DAISY CHAINING (Figure 6)						
SCLK Clock Period	t_{CP}		200			ns
SCLK Pulse-Width High	t_{CH}		80			ns
SCLK Pulse-Width Low	t_{CL}		80			ns
\overline{CS} Fall to SCLK Rise Setup Time	t_{CSS}		25			ns
SCLK Rise to \overline{CS} Rise Hold Time	t_{CSH}		50			ns
DIN Setup Time	t_{DS}		40			ns
DIN Hold Time	t_{DH}		0			ns
SCLK Fall to DOUT Transition	t_{DO1}	$C_{LOAD} = 30pF$			40	ns
\overline{CS} Fall to DOUT Enable	t_{CSE}	$C_{LOAD} = 30pF$			40	ns
\overline{CS} Rise to DOUT Disable	t_{CSD}	$C_{LOAD} = 30pF$			40	ns
SCLK Rise to \overline{CS} Fall Delay	t_{CS0}		50			ns
\overline{CS} Rise to SCLK Rise Hold Time	t_{CS1}		40			ns
\overline{CS} Pulse-Width High	t_{CSW}		100			ns

Note 1: 100% production tested at $T_A = +25^\circ C$. Limits over temperature are guaranteed by design.

Note 2: INL linearity is guaranteed from code 60 to code 1024.

Note 3: Connect a resistor from $FSADJ_$ to GND to adjust the full-scale current. See the *Reference Architecture and Operation* section.

Note 4: Settling time is measured from (0.25 x full scale) to (0.75 x full scale).

Note 5: The device draws higher supply current when the digital inputs are driven with voltages between $(V_{DD} - 0.5V)$ and $(GND + 0.5V)$. See the Supply Current vs. Digital Input Voltage graph in the *Typical Operating Characteristics*.

Dual, 10-Bit, Programmable, 30mA High-Output-Current DAC

MAX5550

Typical Operating Characteristics

($V_{DD} = +3.0V$, $GND = 0$, $V_{REFIN} = +1.25V$, internal reference, $R_{FSADJ_} = 20k\Omega$, $T_A = +25^\circ C$, unless otherwise noted).

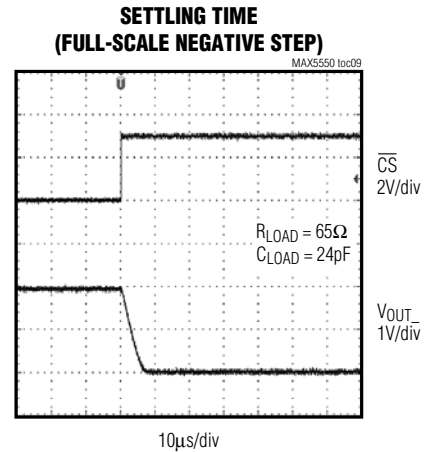
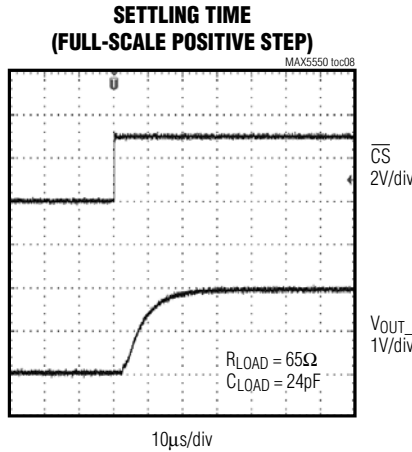
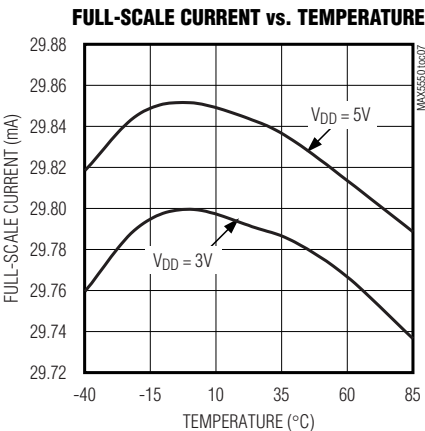
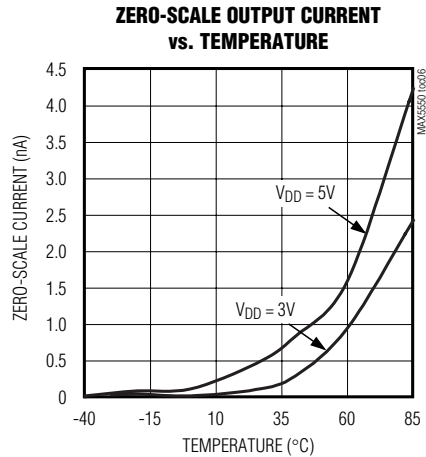
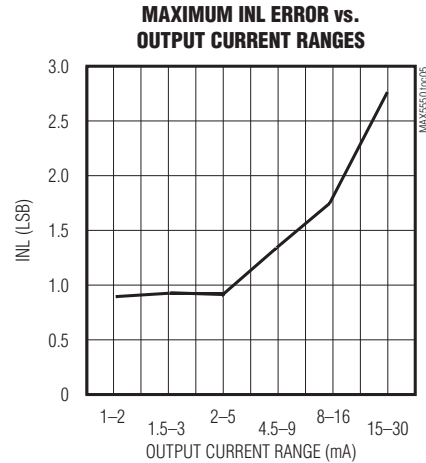
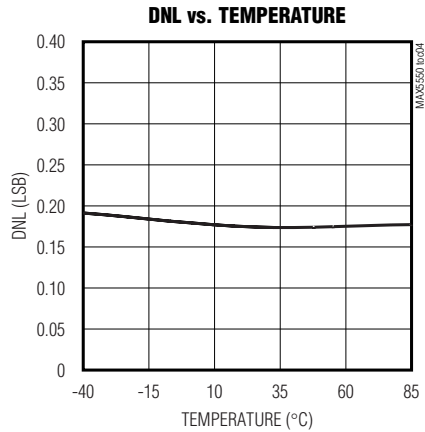
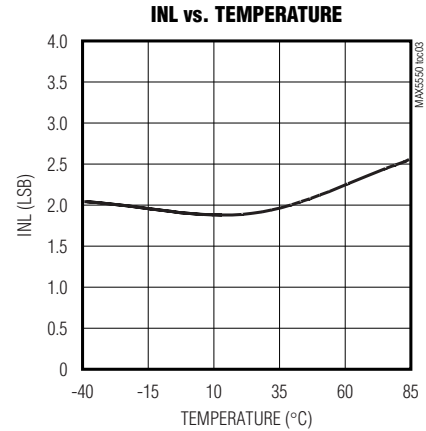
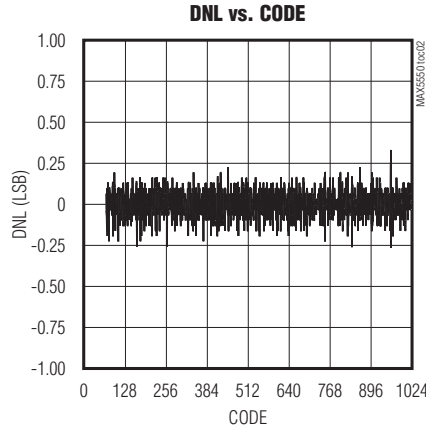
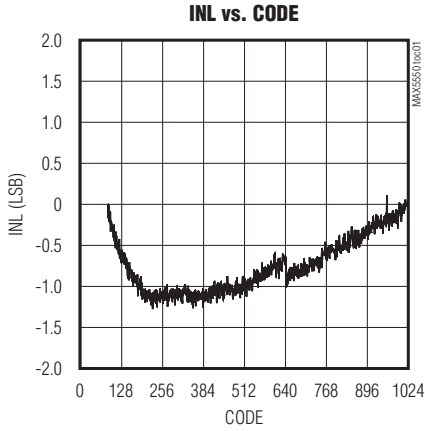

Dual, 10-Bit, Programmable, 30mA High-Output-Current DAC

Typical Operating Characteristics (continued)

($V_{DD} = +3.0V$, $GND = 0$, $V_{REFIN} = +1.25V$, internal reference, $R_{FSADJ_} = 20k\Omega$, $T_A = +25^\circ C$, unless otherwise noted).

GLITCH IMPULSE

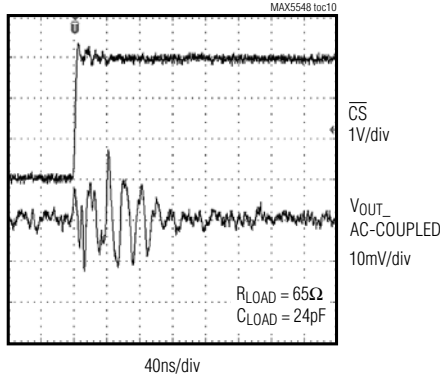

SHUTDOWN CURRENT vs. SUPPLY VOLTAGE

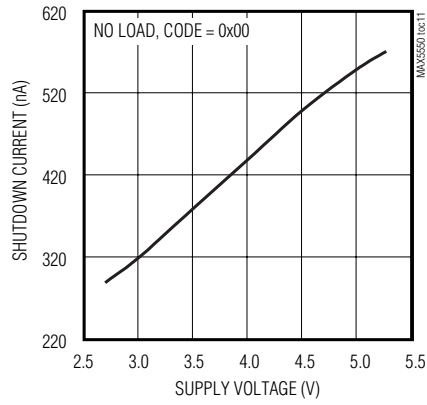

SHUTDOWN CURRENT vs. TEMPERATURE

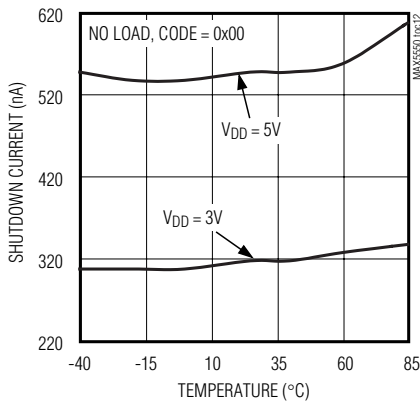

INTERNAL REFERENCE VOLTAGE vs. SUPPLY VOLTAGE

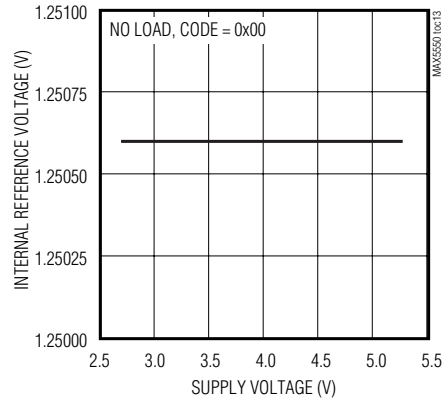

INTERNAL REFERENCE VOLTAGE vs. TEMPERATURE

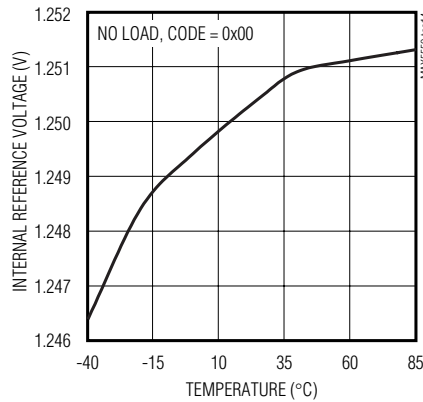

Dual, 10-Bit, Programmable, 30mA High-Output-Current DAC

MAX5550

Typical Operating Characteristics (continued)

($V_{DD} = +3.0V$, $GND = 0$, $V_{REFIN} = +1.25V$, internal reference, $R_{FSADJ_} = 20k\Omega$, $T_A = +25^\circ C$, unless otherwise noted).

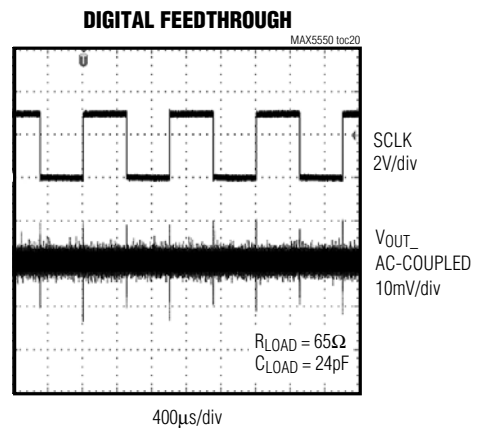
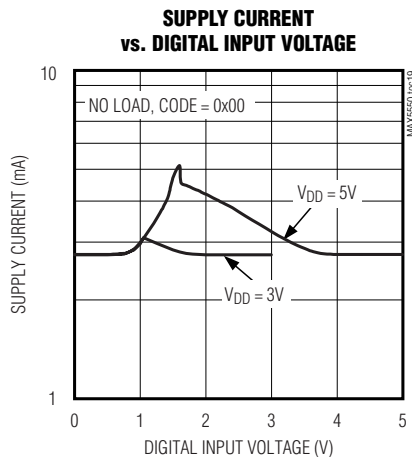
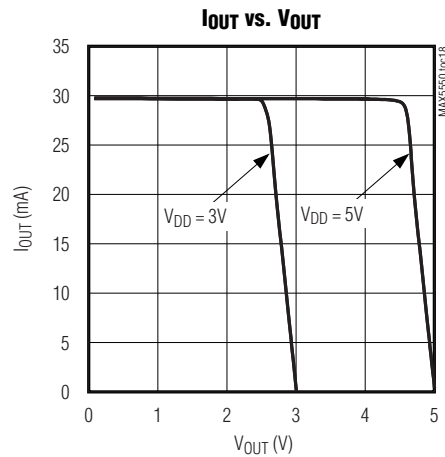
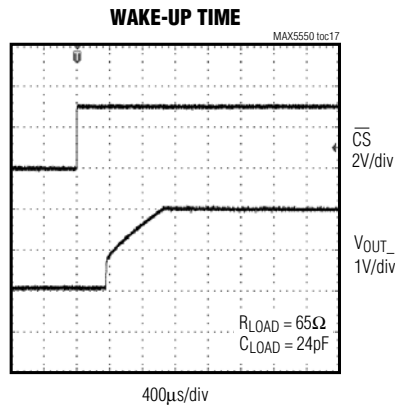
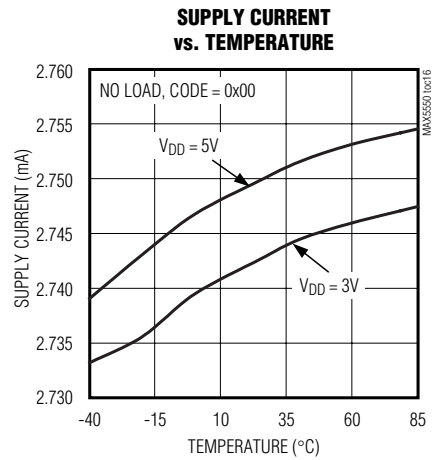
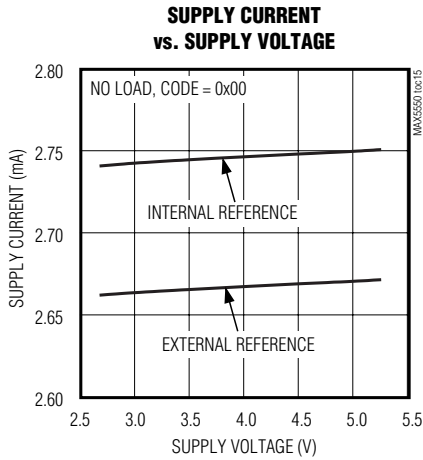

Dual, 10-Bit, Programmable, 30mA High-Output-Current DAC

Pin Description

PIN	NAME	FUNCTION
1	SCLK/SC	Serial Clock Input. Connect SCL to V_{DD} through a 2.4k Ω resistor in I ² C mode.
2	DIN/SDA	Serial Data Input. Connect SDA to V_{DD} through a 2.4k Ω resistor in I ² C mode.
3	$\overline{CS}/A0$	Chip-Select Input in SPI Mode/Address Select 0 in I ² C Mode. \overline{CS} is an active-low input. Connect A0 to V_{DD} or GND to set the device address in I ² C mode.
4	SPI/I ² C	SPI/I ² C Select Input. Connect SPI/I ² C to V_{DD} to select SPI mode, or connect SPI/I ² C to GND to select I ² C mode.
5	DOUT/A1	Serial Data Output in SPI Mode/Address Select 1 in I ² C Mode. Use DOUT to daisy chain the MAX5550 to other devices or to read back in SPI mode. The digital data is clocked out on SCLK's falling edge. Connect A1 to V_{DD} or GND to set the device address in I ² C mode.
6, 13, 15	N.C.	No Connection. Leave unconnected or connect to GND.
7	REFIN	Reference Input. Drive REFIN with an external reference source between +0.5V and +1.5V. Leave REFIN unconnected in internal reference mode. Bypass with a 0.1 μ F capacitor to GND as close to the device as possible.
8, 16	GND	Ground
9	OUTB	DACB Output. OUTB provides up to 30mA of output current.
10	FSADJB	DACB Full-Scale Adjust Input. For maximum full-scale output current, connect a 20k Ω resistor between FSADJB and GND. For minimum full-scale current, connect a 40k Ω resistor between FSADJB and GND.
11	FSADJA	DACA Full-Scale Adjust Input. For maximum full-scale output current, connect a 20k Ω resistor between FSADJA and GND. For minimum full-scale current, connect a 40k Ω resistor between FSADJA and GND.
12	OUTA	DACA Output. OUTA provides up to 30mA of output current.
14	V_{DD}	Power Supply Input. Connect V_{DD} to a +2.7 to +5.25V power supply. Bypass V_{DD} to GND with a 0.1 μ F capacitor as close to the device as possible.
—	EP	Exposed Pad. Connect to GND. Do not use as a substitute ground connection.

Detailed Description

Architecture

The MAX5550 10-bit, dual current-steering DAC (see the *Functional Diagram*) operates with DAC update rates up to 10Msps in SPI mode and 400ksps in I²C mode. The converter consists of a 16-bit shift register and input DAC registers, followed by a current-steering array. The current-steering array generates full-scale currents up to 30mA per DAC. An integrated +1.25V bandgap reference, control amplifier, and an external resistor determine each data converter's full-scale output range.

Reference Architecture and Operation

The MAX5550 provides an internal +1.25V bandgap reference or accepts an external reference voltage source between +0.5V and +1.5V. REFIN serves as the input for an external low-impedance reference source. Leave REFIN unconnected in internal reference mode. Internal or external reference mode is software selectable through the SPI/I²C serial interface.

The MAX5550's reference circuit (Figure 1) employs a control amplifier to regulate the full-scale current (I_{FS}) for the current outputs of the DAC. This device has a software-selectable full-scale current range (see the command summary in Table 4). After selecting a current range, an external resistor ($R_{FSADJ_}$) sets the full-scale current. See Table 1 for a matrix of I_{FS} and R_{FSADJ} selections.

During startup, when the power is first applied, the MAX5550 defaults to the external reference mode, and to the 1mA–2mA full-scale current-range mode.

DAC Data

The 10-bit DAC data is decoded as offset binary, MSB first, with 1 LSB = $I_{FS} / 1024$, and converted into the corresponding current as shown in Table 2.

Serial Interface

The MAX5550 features a pin-selectable SPI/I²C serial interface. Connect SPI/I²C to GND to select I²C mode, or connect SPI/I²C to V_{DD} to select SPI mode. SDA and SCL (I²C mode) and DIN, SCLK, and \overline{CS} (SPI mode) facilitate communication between the MAX5550 and the master. The serial interface remains active in shutdown.

Dual, 10-Bit, Programmable, 30mA High-Output-Current DAC

I²C Compatibility (SPI/I²C = GND)

The MAX5550 is compatible with existing I²C systems (Figure 2). SCL and SDA are high-impedance inputs; SDA has an open-drain output that pulls the data line low during the ninth clock pulse. SDA and SCL require pullup resistors (2.4kΩ or greater) to V_{DD}. Optional resistors (24Ω) in series with SDA and SCL protect the device inputs from high-voltage spikes on the bus lines. Series resistors also minimize crosstalk and undershoot of the bus signals. The communication protocol supports standard I²C 8-bit communications. The device's address is compatible with 7-bit I²C addressing protocol only. Ten-bit address formats are not supported. Only write commands are accepted by the MAX5550.

Note: I²C readback is not supported.

Bit Transfer

One data bit transfers during each SCL rising edge. The MAX5550 requires nine clock cycles to transfer data into or out of the DAC register. The data on SDA must remain stable during the high period of the SCL clock pulse. Changes in SDA while SCL is high are read as control signals (see the *START and STOP Conditions* section). Both SDA and SCL idle high.

START and STOP Conditions

The master initiates a transmission with a START condition (S), (a high-to-low transition on SDA with SCL high). The master terminates a transmission with a STOP condition (P), (a low-to-high transition on SDA while SCL is high) (Figure 3). A START condition from the master signals the beginning of a transmission to the MAX5550. The master terminates transmission by issuing a STOP condition. The STOP condition frees the bus. If a repeated START condition (S_r) is generated instead of a STOP condition, the bus remains active.

Table 1. Full-Scale Output Current and RFSADJ_ Selection Based on a +1.25V (typ) Reference Voltage

FULL-SCALE OUTPUT CURRENT (mA)*						RFSADJ (kΩ)	
1mA–2mA	1.5mA–3mA	2.5mA–5mA	4.5mA–9mA	8mA–16mA	15mA–30mA	Calculated	1% EIA Std
1.00	1.500	2.500	4.500	8.00	15.00	40	40.2
1.25	1.875	3.125	5.625	10.00	18.75	35	34.8
1.50	2.250	3.750	6.750	12.00	22.50	30	30.1
1.75	2.625	4.375	7.875	14.00	26.25	25	24.9
2.00	3.000	5.000	9.000	16.00	30.00	20	20.0

*See the command summary in Table 4.

Table 2. DAC Output Code Table

DAC CODE	I _{out_}
11 1111 1111	$1023 \times \frac{I_{FS}}{1024} - I_{OS} $
10 0000 0000	$512 \times \frac{I_{FS}}{1024} - I_{OS} $
00 0000 0001*	$\frac{I_{FS}}{1024} - I_{OS} $
00 0000 0000	0

*Negative output current values = 0

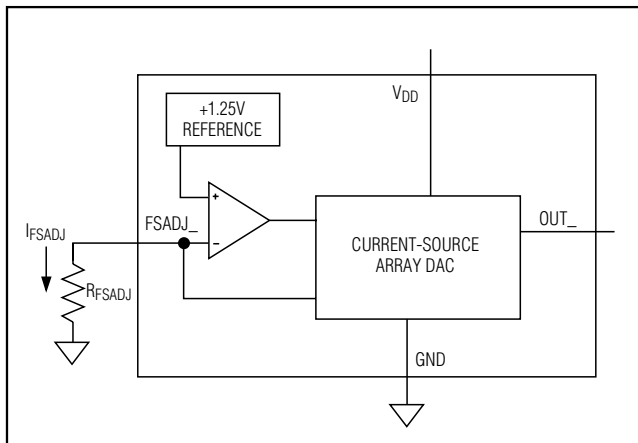

Figure 1. Reference Architecture and Output Current Adjustment

Dual, 10-Bit, Programmable, 30mA High-Output-Current DAC

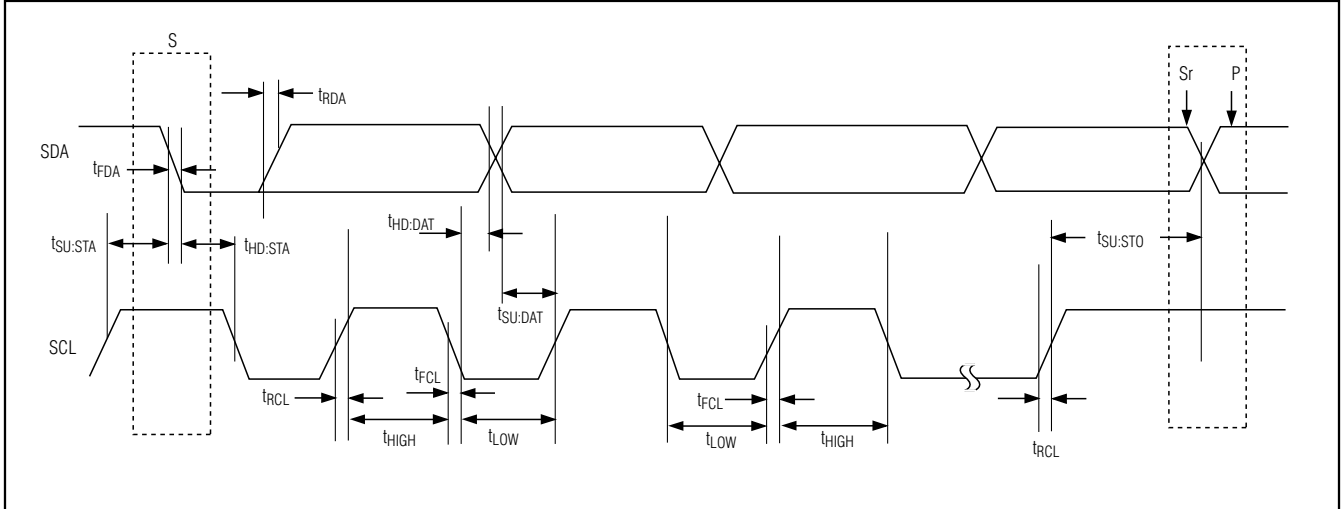

Figure 2. I²C Serial-Interface Timing Diagram

Early STOP Conditions

The MAX5550 recognizes a STOP condition at any point during transmission except if a STOP condition occurs in the same high pulse as a START condition (Figure 4). This condition is not allowed in the I²C format.

Repeated START Conditions

A repeated START (S_r) condition is used when the bus master is writing to several I²C devices and does not want to relinquish control of the bus. The MAX5550's serial interface supports continuous write operations with an S_r condition separating them.

Acknowledge Bit (ACK)

Successful data transfers are acknowledged with an acknowledge bit (ACK). Both the master and the MAX5550 (slave) generate acknowledge bits. To generate an acknowledge, the receiving device must pull SDA low before the rising edge of the acknowledge-related clock pulse (ninth pulse) and keep it low during the high period of the clock pulse (Figure 5).

Monitoring the acknowledge bits allows for detection of unsuccessful data transfers. An unsuccessful data transfer happens if a receiving device is busy or if a system fault has occurred. In the event of an unsuccessful data transfer, the master should reattempt communication at a later time.

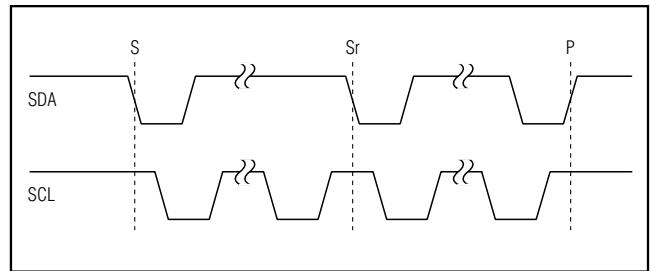

Figure 3. START and STOP Conditions

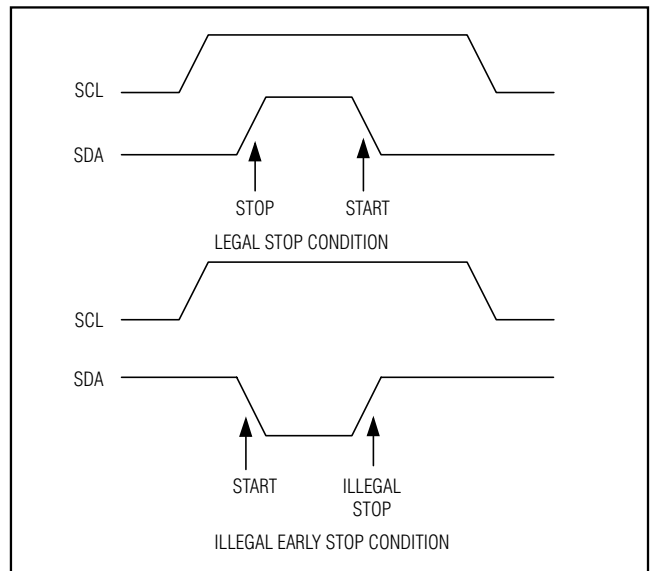

Figure 4. Early STOP Conditions

Dual, 10-Bit, Programmable, 30mA High-Output-Current DAC

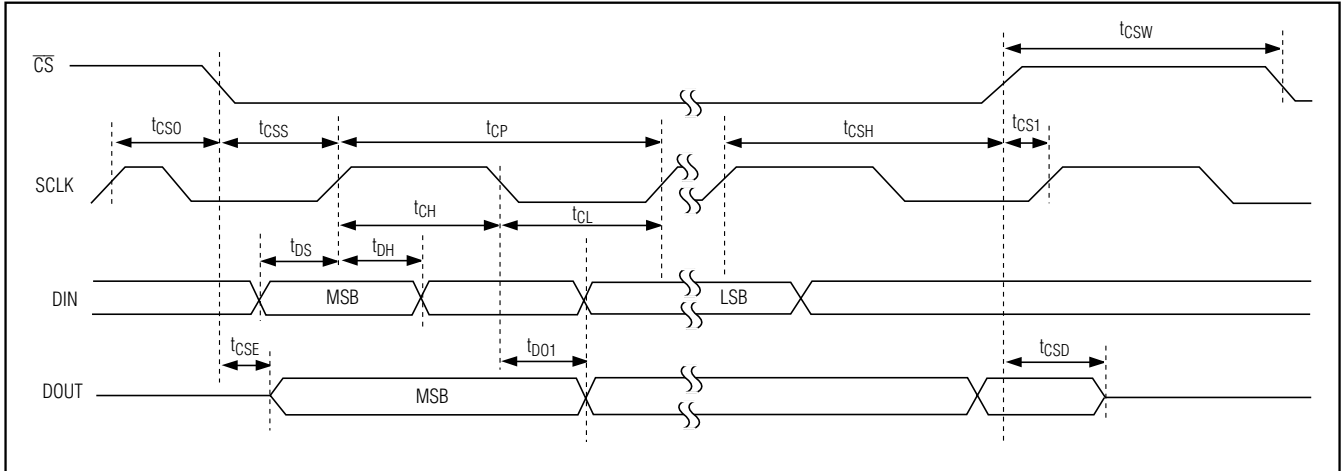

Figure 6. SPI-Interface Timing Diagram

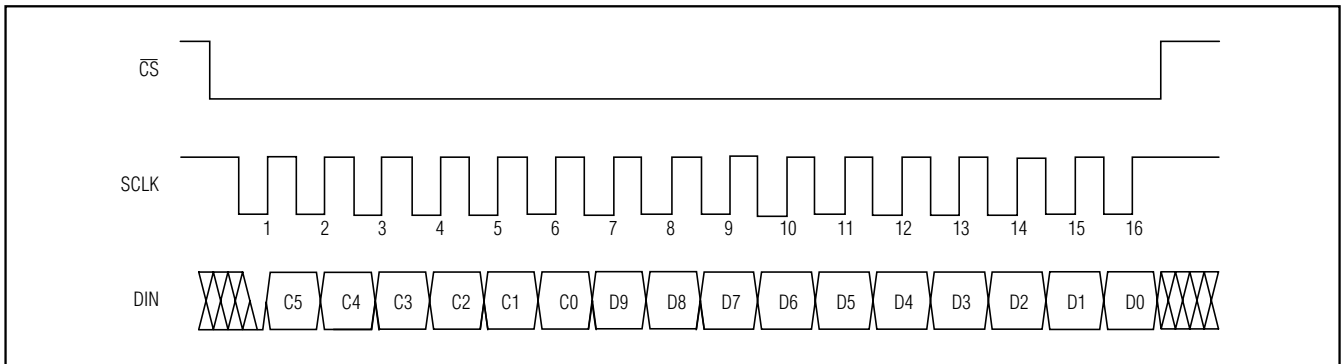

Figure 7. SPI-Interface Format

Applications Information

Daisy Chaining (SPI/I²C = V_{DD})

In standard SPI/QSPI™-/MICROWIRE™-compatible systems, a microcontroller (μC) communicates with its slave devices through a 3- or 4-wire serial interface. The typical interface includes a chip-select signal (\overline{CS}), a serial clock (SCLK), a data input signal (DIN), and sometimes a data signal output (DOUT). In this system, the μC allots an independent slave-select signal (\overline{SS}_i) to each slave device so that they can be addressed individually. Only the slaves with their \overline{CS} inputs asserted low acknowledge and respond to the activity on the serial clock and data lines. This is simple to implement when there are very few slave devices in the system. An alternative method is daisy chaining. Daisy

chaining, in serial-interface applications, is the method of propagating commands through devices connected in series (see Figure 8).

Daisy chain devices by connecting the DOUT of one device to the DIN of the next. Connect the SCLK of all devices to a common clock and connect the \overline{CS} of all devices to a common slave-select line. Data shifts out of DOUT 16.5 clock cycles after it is shifted into DIN on the falling edge of SCLK. In this configuration, the μC only needs three signals (\overline{SS} , SCK, and MOSI) to control all of the slaves in the network. The SPI/QSPI-/MICROWIRE-compatible serial interface normally works at up to 10MHz, but must be slowed to 5MHz if daisy chaining. DOUT is high impedance when \overline{CS} is high.

QSPI is a trademark of Motorola, Inc.

MICROWIRE is a trademark of National Semiconductor Corp.

Dual, 10-Bit, Programmable, 30mA High-Output-Current DAC

MAX5550

Table 4. Command Summary

SERIAL DATA INPUT							FUNCTIONS
C5	C4	C3	C2	C1	C0	D9–D0	
0	0	0	0	0	0	XXXXXXXXXX	No operation.
0	0	0	0	0	1	10-bit DAC data	Load DAC data to both DAC registers and both input registers from the shift register.
0	0	0	0	1	0	10-bit DAC data	Load DAC register A and input register A from the shift register.
0	0	0	0	1	1	10-bit DAC data	Load DAC register B and input register B from the shift register.
0	0	0	1	0	0	10-bit DAC data	Load both channel input registers from the shift register, both DAC registers are unchanged.
0	0	0	1	0	1	10-bit DAC data	Load input register A from the shift register; DAC register A is unchanged.
0	0	0	1	1	0	10-bit DAC data	Load input register B from the shift register; DAC register B is unchanged.
0	0	0	1	1	1	XXXXXXXXXX	Update both DAC registers from their corresponding input registers.
0	0	1	0	0	1	XXXXXXXXXX	Update DAC register A from input register A.
0	0	1	0	1	0	XXXXXXXXXX	Update DAC register B from input register B.
0	0	1	0	1	1	XXXXXXXXXX	Internal reference mode.
0	0	1	1	0	0	XXXXXXXXXX	External reference mode (default mode at power-up).
0	0	1	1	0	1	XXXXXXXXXX	Shut down both DACs.
0	0	1	1	1	0	XXXXXXXXXX	Shut down DACA.
0	0	1	1	1	1	XXXXXXXXXX	Shut down DACB.
0	1	0	0	0	0	XXXXXXXXXX	DACA 1mA–2mA full-scale current range mode (default mode at power-up)
0	1	0	0	0	1	XXXXXXXXXX	DACA 1.5mA–3mA full-scale current range mode.
0	1	0	0	1	0	XXXXXXXXXX	DACA 2.5mA–5mA full-scale current range mode.
0	1	0	0	1	1	XXXXXXXXXX	DACA 4.5mA–9mA full-scale current range mode.
0	1	0	1	0	0	XXXXXXXXXX	DACA 8mA–16mA full-scale current range mode.
0	1	0	1	0	1	XXXXXXXXXX	DACA 15mA–30mA full-scale current range mode.
1	0	1	1	0	1	XXXXXXXXXX	Power up both DACs.
1	0	1	1	1	0	XXXXXXXXXX	Power up DACA.
1	0	1	1	1	1	XXXXXXXXXX	Power up DACB.
1	1	0	0	0	0	XXXXXXXXXX	DACB 1mA–2mA full-scale current range mode (default mode at power-up)
1	1	0	0	0	1	XXXXXXXXXX	DACB 1.5mA–3mA full-scale current range mode.
1	1	0	0	1	0	XXXXXXXXXX	DACB 2.5mA–5mA full-scale current range mode.
1	1	0	0	1	1	XXXXXXXXXX	DACB 4.5mA–9mA full-scale current range mode.
1	1	0	1	0	0	XXXXXXXXXX	DACB 8mA–16mA full-scale current range mode.
1	1	0	1	0	1	XXXXXXXXXX	DACB 15mA–30mA full-scale current range mode.

Dual, 10-Bit, Programmable, 30mA High-Output-Current DAC

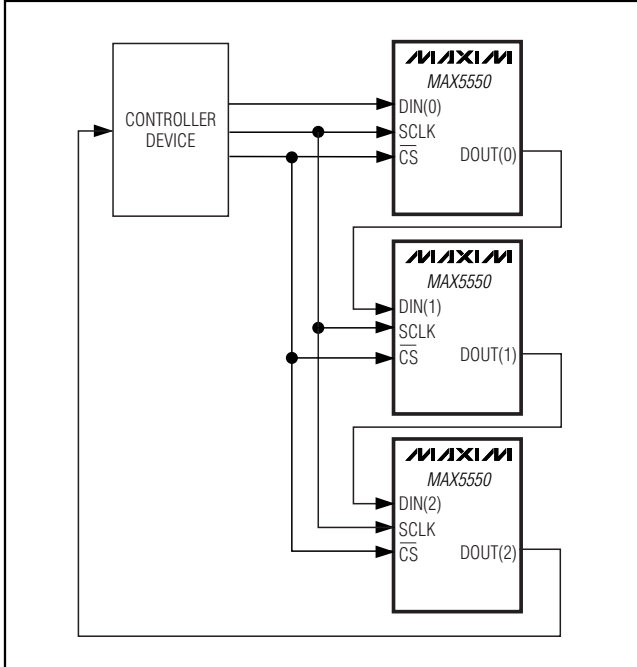

Figure 8. Daisy-Chain Configuration

Power Sequencing

Ensure that the voltage applied to REFIN does not exceed V_{DD} at any time. If proper power sequencing is not possible, connect an external Schottky diode between REFIN and V_{DD} to ensure compliance with the absolute maximum ratings.

Power-Supply Bypassing and Ground Management

Digital or AC transient signals on GND create noise at the analog output. Return GND to the highest quality ground plane available. For extremely noisy environments, bypass REFIN and V_{DD} to GND with $1\mu\text{F}$ and $0.1\mu\text{F}$ capacitors with the $0.1\mu\text{F}$ capacitor as close to the device as possible. Careful PC board ground layout minimizes crosstalk between the DAC outputs and digital inputs.

Pin Configuration

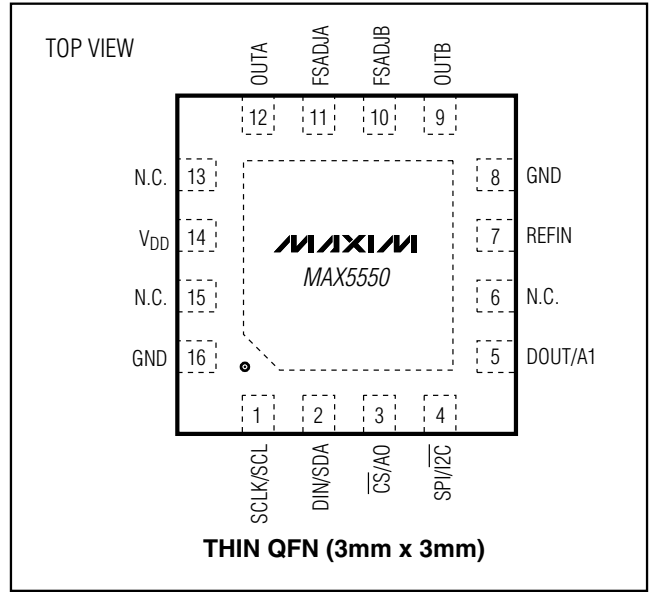

Chip Information

PROCESS: BiCMOS

Dual, 10-Bit, Programmable, 30mA High-Output-Current DAC

Package Information

(The package drawing(s) in this data sheet may not reflect the most current specifications. For the latest package outline information, go to www.maxim-ic.com/packages.)

MAX5550

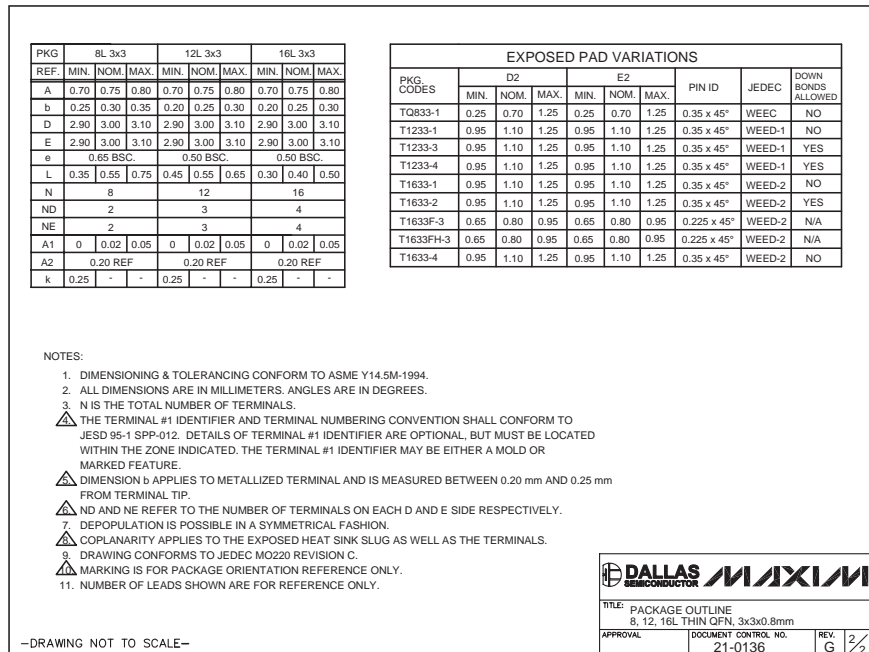
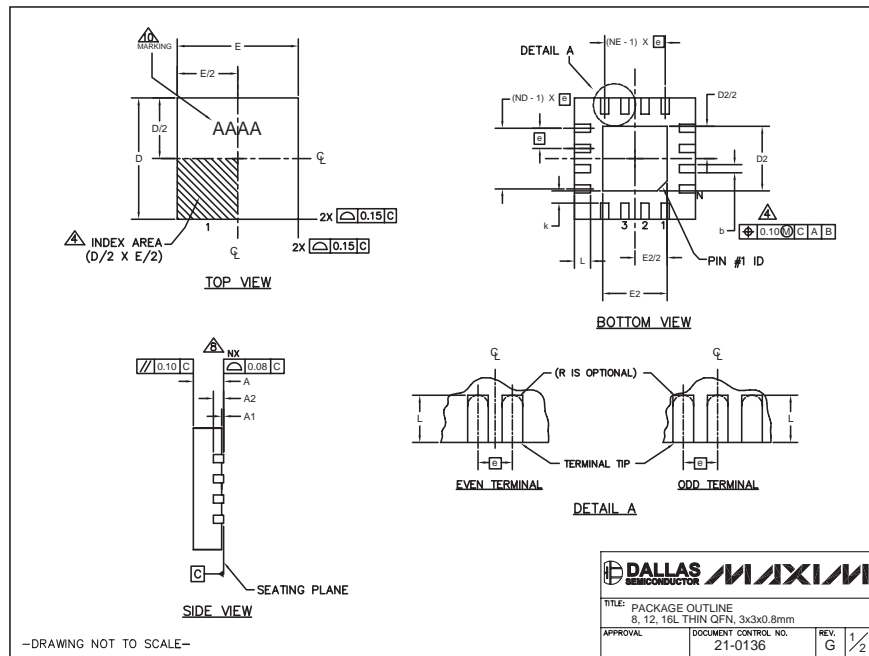

Maxim cannot assume responsibility for use of any circuitry other than circuitry entirely embodied in a Maxim product. No circuit patent licenses are implied. Maxim reserves the right to change the circuitry and specifications without notice at any time.

Maxim Integrated Products, 120 San Gabriel Drive, Sunnyvale, CA 94086 408-737-7600 15