

03

SV ...-8

Circular connectors with threaded joint M16 acc. to IEC 61076-2-106, IP40/IP68



Plug acc. to IEC 61076-2-106, IP40, straight version, with threaded joint, solder terminals and short bend protection

03

SV ...-8

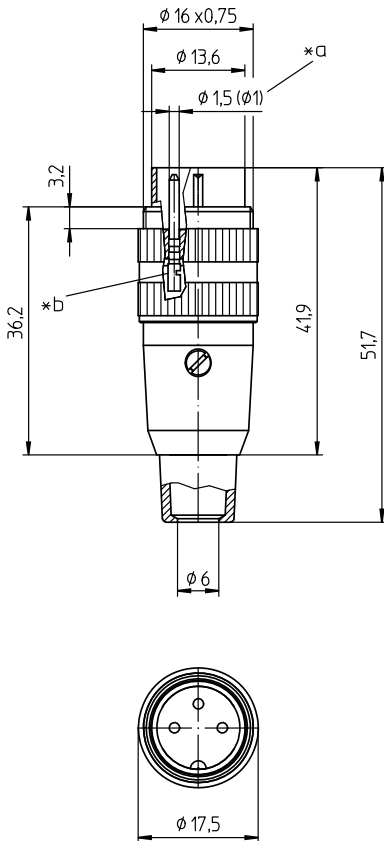

Environmental conditions

Temperature range -40 °C/+85 °C

Materials

Insulating body	PA GF, V-0 according to UL94
Contact pin	CuZn, silver-plated and flash gold-plated (3-8 poles) CuZn, pre-nickel and gold-plated (12 poles)
Ground contact spring	CuZn, pre-nickel and tin-plated
Sleeve	PC, HB according to UL94
Strain relief	steel, nickel-plated
Housing	CuZn, nickel-plated
Knurled screw	CuZn, nickel-plated
Bend protection sleeve	TPE
Screw	steel, nickel-plated

Mechanical data

Tightening torque connector 1-3 Nm
Protection class IP40¹

¹ according to IEC DIN EN 60529, only in locked condition with an appropriate counterpart

Connectable conductors for solder area

Section ≤ 0.75 mm² (AWG 20) (3-8 poles)
≤ 0.25 mm² (AWG 24) (12 poles)
Cable diameter 6-8 mm

Electrical data (at T_{amb} 20 °C)

Rated current 5 A (T_{amb} 40 °C, 3-8 poles)
3 A (T_{amb} 40 °C, 12 poles)
Rated voltage with pollution degree 1:
300 V (versions 30, 40, 50/6, 60, 70)
100 V (versions 50, 71, 80, 81)
160 V (Polbild 120)
with pollution degree 2:
250 V (versions 30, 40)
32 V (versions 50, 71, 80, 81)
160 V (versions 50/6, 60, 70, 120)
Rated impulse voltage 1500 V (versions 30, 40, 50/6, 60, 70, 120)
500 V (versions 50, 71, 80, 81)
Material group II (IEC)/I (UL) (400 ≅ CTI < 600)
Overvoltage category I
Insulation resistance > 100 MΩ

Pin configurations, solder side view

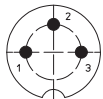

03-a
SV 30-8

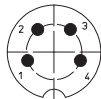

04-a
SV 40-8

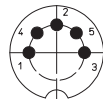

05-b
SV 50-8

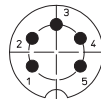

05-a
SV 50/6-8

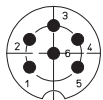

06-a
SV 60-8

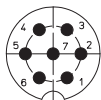

07-a
SV 70-8

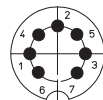

07-b
SV 71-8

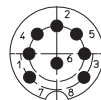

SV 80-8

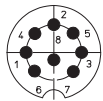

08-a
SV 81-8

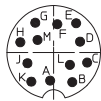

12-a
SV 120-8

- *a 12 pole version Ø 1.0 mm
- *b cup-shaped solder terminal

Associated products

Counterparts

030398	KFR	KfV
KGR	KGV	KV
KV ... C	KV ...-8	WKV
WKV ... C		

Accessories

0383	038399	038899
----------------------	------------------------	------------------------

03

SV ...-8

Designation	Pole Number	PU (Pieces)	MDQ (Pieces)
SV 30-8	3	50	500
SV 40-8	4	50	500
SV 50-8	5	50	500
SV 50/6-8	5	50	500
SV 60-8	6	50	500
SV 70-8	7	50	500
SV 71-8	7	50	500
SV 80-8	8	50	500
SV 81-8	8	50	500
SV 120-8	12	50	500

Packaging:

pre-assembled, in a cardboard box