



LED Display Product Data Sheet LTS-2801AE

Spec No.: DS-30-99-658

Effective Date: 06/09/2010

Revision: A

LITE-ON DCC

RELEASE

BNS-OD-FC001/A4

LITEON LITE-ON TECHNOLOGY CORPORATION

Property of Lite-on Only

FEATURES

- * 0.28-inch (7.0-mm) DIGIT HEIGHT.
- * CONTINUOUS UNIFORM SEGMENTS.
- * LOW POWER REQUIREMENT.
- * EXCELLENT CHARACTERS APPEARANCE.
- * HIGH BRIGHTNESS & HIGH CONTRAST.
- * WIDE VIEWING ANGLE.
- * SOLID STATE RELIABILITY.
- * CATEGORIZED FOR LUMINOUS INTENSITY.

DESCRIPTION

The LTS-2801AE is a 0.28-inch (7.0-mm) digit height single digit seven-segment display. This device utilizes red orange LED chips, which are made from GaAsP on a transparent GaP substrate, and has a gray face and white segments.

DEVICE

PART NO.	DESCRIPTION
RED ORANGE	Common Anode
LTS-2801AE	Rt. Hand Decimal

PACKAGE DIMENSIONS

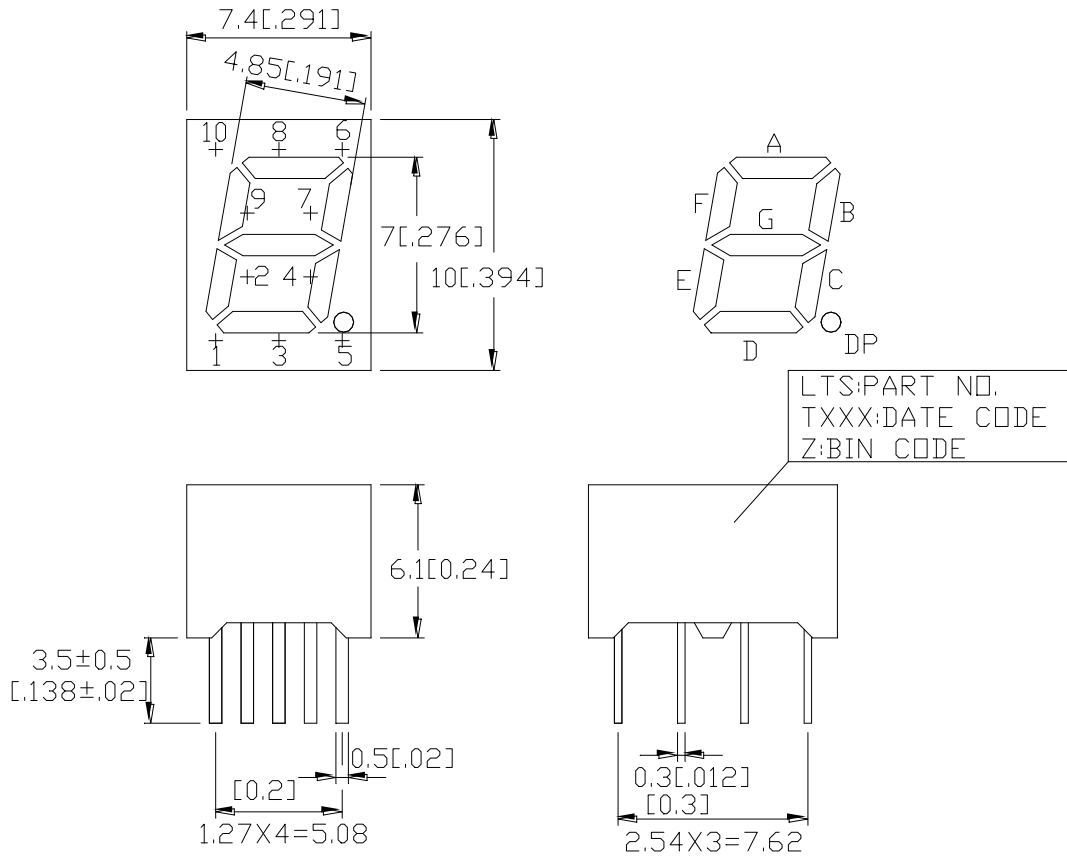

NOTES: All dimensions are in millimeters. Tolerance is ± 0.25 mm (0.01") unless otherwise noted.

INTERNAL CIRCUIT DIAGRAM

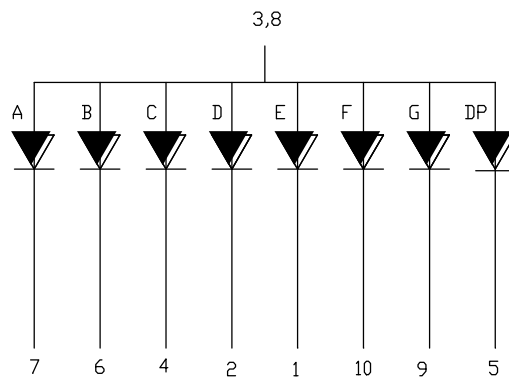

PIN CONNECTION

No.	CONNECTION
1	CATHODE E
2	CATHODE D
3	COMMON ANODE
4	CATHODE C
5	CATHODE D.P.
6	CATHODE B
7	CATHODE A
8	COMMON ANODE
9	CATHODE G
10	CATHODE F

LITEON LITE-ON TECHNOLOGY CORPORATION

Property of Lite-on Only

ABSOLUTE MAXIMUM RATING AT $T_A=25^{\circ}\text{C}$

PARAMETER	MAXIMUM RATING	UNIT
Power Dissipation Per Segment	75	mW
Peak Forward Current Per Segment (1/10 Duty Cycle, 0.1ms Pulse Width)	100	mA
Continuous Forward Current Per Segment Derating Linear From 25°C Per Segment	25 0.33	mA $\text{mA}/^{\circ}\text{C}$
Reverse Voltage Per Segment	5	V
Operating Temperature Range	-35°C to $+85^{\circ}\text{C}$	
Storage Temperature Range	-35°C to $+85^{\circ}\text{C}$	
Solder Temperature: max 260°C for max 3sec at 1.6mm below seating plane.		

ELECTRICAL / OPTICAL CHARACTERISTICS AT $T_A=25^{\circ}\text{C}$

PARAMETER	SYMBOL	MIN.	TYP.	MAX.	UNIT	TEST CONDITION
Average Luminous Intensity	I_v	800	2000		μcd	$I_F=10\text{mA}$
Peak Emission Wavelength	λ_p		630		nm	$I_F=20\text{mA}$
Spectral Line Half-Width	$\Delta\lambda$		40		nm	$I_F=20\text{mA}$
Dominant Wavelength	λ_d		621		nm	$I_F=20\text{mA}$
Forward Voltage Per Segment	V_F		2.0	2.6	V	$I_F=20\text{mA}$
Reverse Current Per Segment	I_R			100	μA	$V_R=5\text{V}$
Luminous Intensity Matching Ratio	$I_v\text{-m}$			2:1		$I_F=10\text{mA}$

Note: Luminous intensity is measured with a light sensor and filter combination that approximates the CIE (commission international DE L'clairage) eye-response curve.

TYPICAL ELECTRICAL / OPTICAL CHARACTERISTIC CURVES

(25°C Ambient Temperature Unless Otherwise Noted)

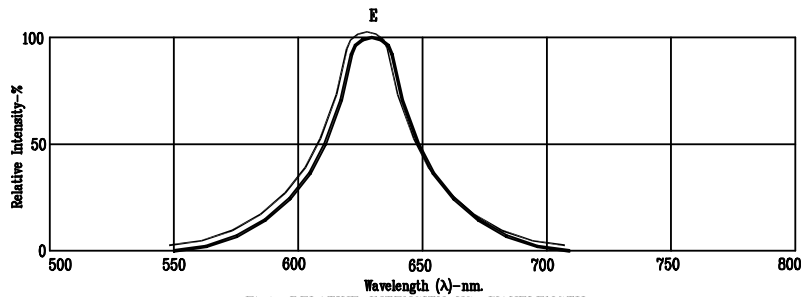

Fig1. RELATIVE INTENSITY VS. WAVELENGTH

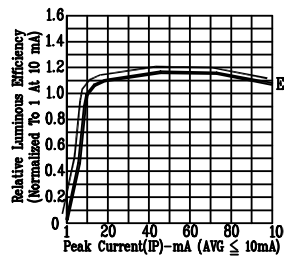

Fig2. RELATIVE LUMINOUS EFFICIENCY (LUMINOUS INTENSITY PER UNIT CURRENT) VS. PEAK CURRENT (REFRESH RATE 1KHz)

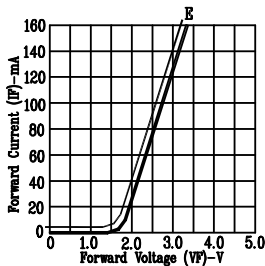

Fig3. FORWARD CURRENT VS. FORWARD VOLTAGE

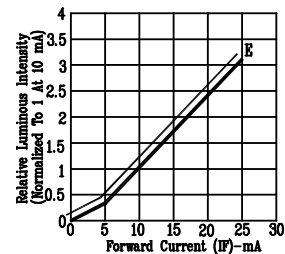

Fig4. RELATIVE LUMINOUS INTENSITY VS. FORWARD CURRENT

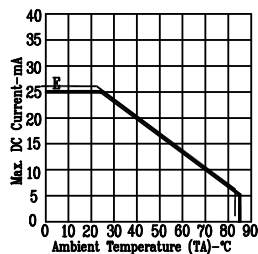

Fig5. MAX. ALLOWABLE DC CURRENT VS. AMBIENT TEMPERATURE

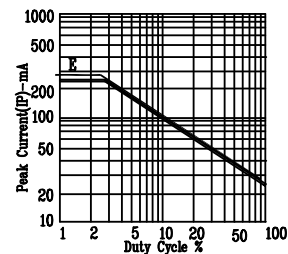

Fig6. MAX. PEAK CURRENT VS. DUTY CYCLE % (REFRESH RATE 1KHz)

NOTE: E=RED ORANGE