

LITEON

0.8" Single Digit Numeric LED Display LTS-3400L Series

Features

- 0.8 inch (20.32mm) digit height.
- Continuous uniform segments.
- Choices of five bright colors-ALGaAs red/bright red/green/yellow/red orange.
- Low power requirement.
- Excellent characters appearance.
- High contrast.
- High brightness.
- Wide viewing angle.
- Solid state reliability.
- Categorized for luminous intensity.
- I.C. compatible.
- Easy mounting on P.C. board or socket.

Description

The LTS-3400L series are 0.8 inch (20.32mm) height 7-segment displays. All devices displays have gray face and white segments .

The ALGaAs red series displays are designed for applications requiring low power consumption. They are tested and selected for their excellent low current characteristics to ensure that the segments are matched at low current. Driver current as low as 1mA per segment is available.

The ALGaAs red series devices utilize LED chips which are made from ALGaAs on a non-transparent GaAs substrate. The bright red and green series devices utilize LED chips which are made from GaP on a transparent GaP substrate. The yellow and red orange series devices utilize LED chips which are made from GaAsP on a transparent GaP substrate.

Package Dimensions

A.LTS-3401L/3403L

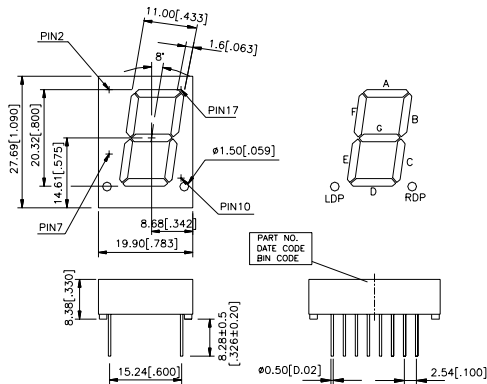

B.LTS-3406L

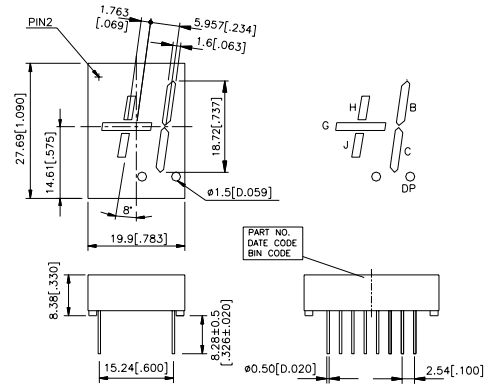

Notes: All dimensions are in millimeters (inches). Tolerance: $\pm 0.25\text{mm}$ (0.01") unless otherwise noted.

Devices

Part No. LTS-					Description	Package Dimension	Internal Circuit Diagram
ALGaAs Red	Bright Red	Green	Yellow	Red Orange			
3401LWC	3401LP	3401LG	3401LY	3401LE	Common Anode, Rt. & Lt. Hand Decimal	A	A
3403LWC	3403LP	3403LG	3403LY	3403LE	Common Cathode, Rt. & Lt. Hand Decimal	A	B
3406LWC	3406LP	3406LG	3406LY	3406LE	Universal, ± 1 Overflow Rt. & Lt. Hand Decimal	B	C

9-164

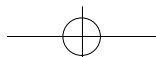

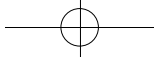

Pin Connection

Pin No.	Connection		
	A.LTS-3401L	B.LTS-3403L	C.LTS-3406L
1.	No Pin	No Pin	No Pin
2.	Cathode A	Anode A	Cathode B *2
3.	Cathode F	Anode F	Anode H
4.	Common Anode *1	Common Cathode *1	Cathode H
5.	Cathode E	Anode E	Cathode G
6.	Common Anode *1	Common Cathode *1	Cathode J
7.	Cathode L.D.P.	Anode L.D.P.	Anode J
8.	No Pin	No Pin	Cathode D.P. *3
9.	No Pin	No Pin	No Pin
10.	Cathode R.D.P.	Anode R.D.P.	Anode D.P.
11.	Cathode D	Anode D	Cathode D.P.*3
12.	Common Anode *1	Common Cathode *1	Cathode C
13.	Cathode C	Anode C	Anode C
14.	Cathode G	Anode G	Anode G
15.	Cathode B	Anode B	Anode B
16.	No pin	No pin	No pin
17.	Common Anode *1	Common Cathode *1	Cathode B *2
18.	No pin	No pin	No pin

Notes: 1. Pin 4 & 6、12 & 17 are internally connect. 2. Pin 2 & 17 are internally connected. 3. Pin 8 & 11 are internally connected.

DISPLAYS

Internal Circuit Diagrams

A.LTS-3401L

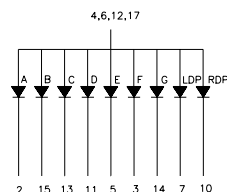

B.LTS-3403L

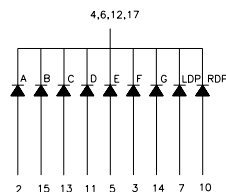

C.LTS-3406L

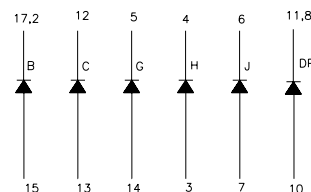

Absolute Maximum Rating at Ta=25°C

Parameter	AlGaAs Red	Bright Red	Green	Yellow	Red Orange	Unit
Power Dissipation Per Segment	75	40	75	60	75	mW
Peak Forward Current Per Segment (1/10 Duty Cycle, 0.1ms Pulse Width)	125	60	100	80	100	mA
Continuous Forward Current Per Segment Derating Linear from 25°C Per Segment	30	15	25	20	25	mA
Reverse Voltage Per Segment	5	5	5	5	5	V
Operating Temperature Range	-35°C to +85°C					
Storage Temperature Range	-35°C to +85°C					
Solder Temperature 1/16 Inch Below Seating Plane for 3 Seconds at 260°C						

Electrical/Optical Characteristics at Ta=25°C

LTS-3401LWC/3403LWC/3406LWC

Parameter	Symbol	Min.	Typ.	Max.	Unit	Tset Condition
Average Luminous Intensity	I _v	320	700		μ cd	I _F =1mA
			3750			I _F =5mA
Peak Emission Wavelength	λ _P		660		nm	I _F =20mA
Spectral Line Half-Width	Δλ		35		nm	I _F =20mA
Dominant Wavelength	λ _d		638		nm	I _F =20mA
Forward Voltage, Per Segment	V _F		1.6	2.4	V	I _F =1mA
			1.7			I _F =5mA
			1.8			I _F =20mA
Reverse Current, Per Segment	I _R			100	μ A	V _R =5V
Luminous Intensity Matching Ratio	I _v -m			2:1		I _F =1mA

9-165

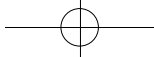

LTS-3401/3403/3406LP

Parameter	Symbol	Min.	Typ.	Max.	Unit	Tset Condition
Average Luminous Intensity	I_v	320	950		μ cd	$I_F=10mA$
Peak Emission Wavelength	λP		697		nm	$I_F=20mA$
Spectral Line Half-Width	$\Delta \lambda$		90		nm	$I_F=20mA$
Dominant Wavelength	λd		657		nm	$I_F=20mA$
Forward Voltage, Per Segment or D.P.	V_F		2.1	2.6	V	$I_F=20mA$
Reverse Current, Per Segment or D.P.	I_R			100	μ A	$V_R=5V$
Luminous Intensity Matching Ratio	I_v-m			2:1		$I_F=10mA$

LTS-3401/3403/3406LG

Parameter	Symbol	Min.	Typ.	Max.	Unit	Tset Condition
Average Luminous Intensity	I_v	800	2400		μ cd	$I_F=10mA$
Peak Emission Wavelength	λP		565		nm	$I_F=20mA$
Spectral Line Half-Width	$\Delta \lambda$		30		nm	$I_F=20mA$
Dominant Wavelength	λd		569		nm	$I_F=20mA$
Forward Voltage, Per Segment	V_F		2.1	2.6	V	$I_F=20mA$
Reverse Current, Per Segment	I_R			100	μ A	$V_R=5V$
Luminous Intensity Matching Ratio	I_v-m			2:1		$I_F=10mA$

LTS-3401/3403/3406LY

Parameter	Symbol	Min.	Typ.	Max.	Unit	Tset Condition
Average Luminous Intensity	I_v	800	2400		μ cd	$I_F=10mA$
Peak Emission Wavelength	λP		585		nm	$I_F=20mA$
Spectral Line Half-Width	$\Delta \lambda$		35		nm	$I_F=20mA$
Dominant Wavelength	λd		588		nm	$I_F=20mA$
Forward Voltage, Per Segment	V_F		2.1	2.6	V	$I_F=20mA$
Reverse Current, Per Segment	I_R			100	μ A	$V_R=5V$
Luminous Intensity Matching Ratio	I_v-m			2:1		$I_F=10mA$

LTS-3401/3403/3406LE

Parameter	Symbol	Min.	Typ.	Max.	Unit	Tset Condition
Average Luminous Intensity	I_v	800	2400		μ cd	$I_F=10mA$
Peak Emission Wavelength	λP		630		nm	$I_F=20mA$
Spectral Line Half-Width	$\Delta \lambda$		40		nm	$I_F=20mA$
Dominant Wavelength	λd		621		nm	$I_F=20mA$
Forward Voltage, Per Segment	V_F		2.0	2.6	V	$I_F=20mA$
Reverse Current, Per Segment	I_R			100	μ A	$V_R=5V$
Luminous Intensity Matching Ratio	I_v-m			2:1		$I_F=10mA$

Note: Luminous intensity is measured with a light sensor and filter combination that approximates the CIE (Commission Internationale De L'Eclairage) eye-response curve.



Typical Electrical/Optical Characteristic Curves (25°C Ambient Temperature Unless Otherwise Noted)

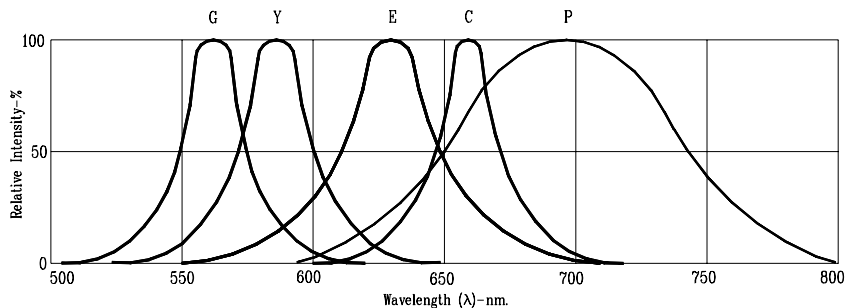

Fig1. RELATIVE INTENSITY VS. WAVELENGTH

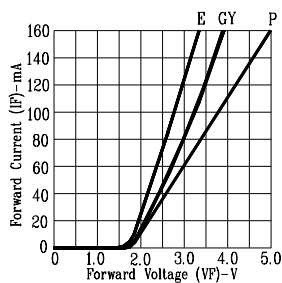

Fig2. FORWARD CURRENT VS. FORWARD VOLTAGE

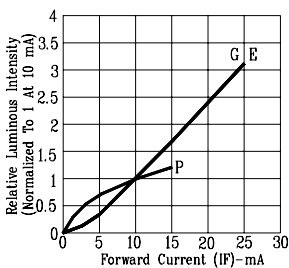

Fig3. RELATIVE LUMINOUS INTENSITY VS. FORWARD CURRENT

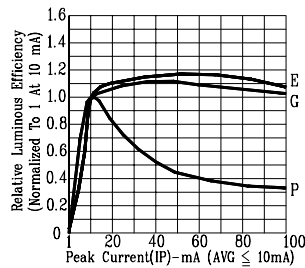

Fig4. RELATIVE LUMINOUS EFFICIENCY (LUMINOUS INTENSITY PER UNIT CURRENT) VS. PEAK CURRENT

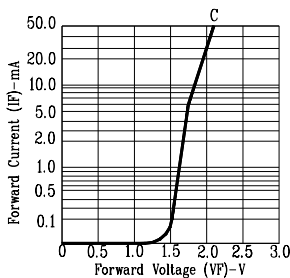

Fig5. FORWARD CURRENT VS. FORWARD VOLTAGE

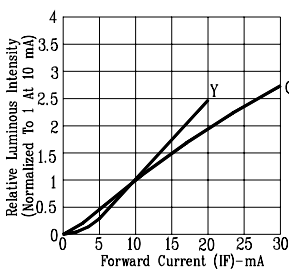

Fig6. RELATIVE LUMINOUS INTENSITY VS. FORWARD CURRENT

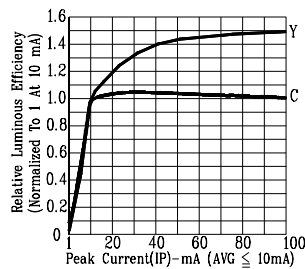

Fig7. RELATIVE LUMINOUS EFFICIENCY (LUMINOUS INTENSITY PER UNIT CURRENT) VS. PEAK CURRENT

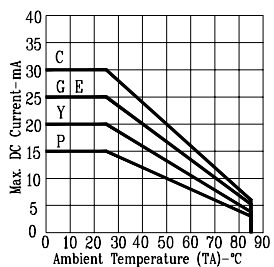

Fig8. MAX. ALLOWABLE DC CURRENT. VS. AMBIENT TEMPERATURE.

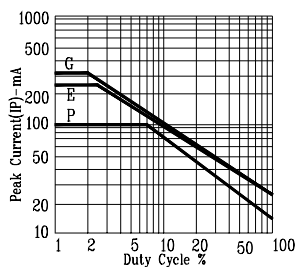

Fig9. MAX. PEAK CURRENT VS. DUTY CYCLE % (REFRESH RATE 1KHz)

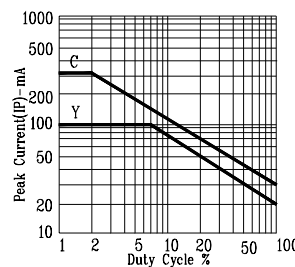

Fig10. MAX. PEAK CURRENT VS. DUTY CYCLE % (REFRESH RATE 1KHz)

NOTE: P=BRIGHT RED E=RED ORANGE G=GREEN Y=YELLOW C=AlGaAs RED (REFRESH RATE 1KHz)

DISPLAYS